

HOSE ENDS

Our hose ends are traditional barbed nickel-plated and brass fittings.

They are suited for connecting smooth or reinforced flexible hoses with an internal diameter up to 76 mm.

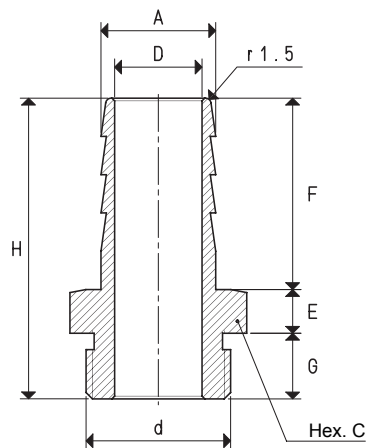

Art.	d Ø	A Ø	C	D Ø	E	F	G	H	Material	Weight g
RS 1/4"	G1/4"	9	17	5	5	18	12	35	nickel-plated brass	20
RS 3/8"	G3/8"	13	19	9	5	20	8	33	nickel-plated brass	30
RS 1/2"	G1/2"	16	23	12	5	25	10	40	nickel-plated brass	50
RS 3/4"	G3/4"	21	28	16	8	35	12	55	nickel-plated brass	90
RS 1"	G1"	27	36	22	8	35	12	55	nickel-plated brass	130
RS 1" 1/4	G1" 1/4	35	44	28	10	42	15	67	nickel-plated brass	270
RS 1" 1/2	G1" 1/2	40	50	33	10	45	15	70	nickel-plated brass	320
RS 3"	G3"	76	100	66	10	60	30	100	nickel-plated brass	1450

FITTINGS AND CAPS

The fittings described in this page are particularly indicated for connecting vacuum cup holders to their manifolds and in all those cases that require a connection to vacuum sources via smooth flexible hoses with internal diameters of 4, 6 and 9 mm, which is the maximum allowed for a vacuum hose with no internal reinforcement.

These are semi-rapid fittings. The hose is fixed by manually screwing the reeded bush with no need for keys.

The threaded connections are male and female, according to the requirements. The range is completed by L and T-type fittings and caps with O-rings.

The fittings are available in practical 10 or 50-piece packages and are supplied with their nylon seal.

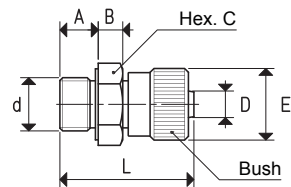

MALE FITTING

Art.	d Ø	A	B	C	D hose int. Ø	E Ø	L	Fitting material	Bush material	Weight g
RM M5	M5	5.0	3.5	10	4	10	19.5	tropicalised iron	anodised aluminium	6
RM 1/8"	G1/8"	7.0	4.5	14	4	13	24.5	anodised aluminium	anodised aluminium	6
RM 1/4"	G1/4"	8.5	5.0	17	6	15	27.0	anodised aluminium	anodised aluminium	10
RM 3/8"	G3/8"	10.5	5.0	19	9	20	32.5	anodised aluminium	anodised aluminium	18

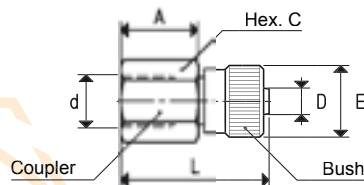

FEMALE FITTING

Art.	d Ø	A	C	D hose int. Ø	E Ø	L	Fitting material	Bush material	Weight g
RF 1/8"	G1/8"	14	14	4	13	27.0	anodised aluminium	anodised aluminium	8
RF 1/4"	G1/4"	16	17	6	15	30.0	anodised aluminium	anodised aluminium	12
RF 3/8"	G3/8"	20	19	9	20	32.5	anodised aluminium	anodised aluminium	16

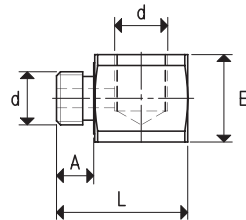

L-TYPE FITTINGS

Art.	d ∅	A	E	L	Fitting material	Weight g
RL M5	M5	4.5	10	15.0	anodised aluminium	2
RL 1/8"	G1/8"	7.0	16	24.0	anodised aluminium	10
RL 1/4"	G1/4"	9.0	22	30.0	anodised aluminium	22
RL 3/8"	G3/8"	11.0	25	32.5	anodised aluminium	30

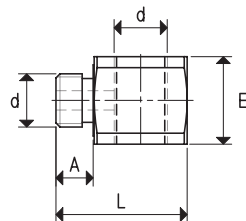

T-TYPE FITTINGS

Art.	d ∅	A	E	L	Fitting material	Weight g
RT M5	M5	4.5	10	15.0	anodised aluminium	1
RT 1/8"	G1/8"	7.0	16	24.0	anodised aluminium	9
RT 1/4"	G1/4"	9.0	22	30.0	anodised aluminium	21
RT 3/8"	G3/8"	11.0	25	32.5	anodised aluminium	29

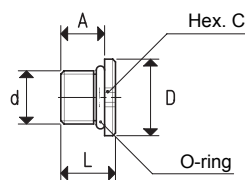

CAP WITH O-RING

Art.	d ∅	A	C	D ∅	L	Fitting material	Weight g
00 15 291	M5	4	2.5	8	6.5	nickel-plated brass	1
00 11 44	G1/8"	7	3.0	15	9.5	nickel-plated brass	6
00 11 06	G1/4"	8	6.0	18	11.0	nickel-plated brass	10
00 18 33	G3/8"	9	8.0	21	12.5	nickel-plated brass	18
00 15 273	G1/2"	11	10.0	26	14.5	nickel-plated brass	21

Conversion ratio: inch = $\frac{\text{mm}}{25.4}$; pounds = $\frac{\text{g}}{453.6} = \frac{\text{Kg}}{0.4536}$

GAS-NPT thread adapters available at page 1.117

ROTATING QUICK COUPLING FITTINGS

Quick coupling fittings are composed of a jack with hose end connector and a threaded male coupler which connects itself to the jack.

They are fixed by a ball ring pushed by a spring. A nitrile rubber seal guarantees a perfect vacuum seal.

This type of fitting allows the two components to rotate freely at a low speed and to rapidly couple and disconnect by manually acting on the jack reeded ring nut.

These fittings are fully made with brass and are available in various sizes.

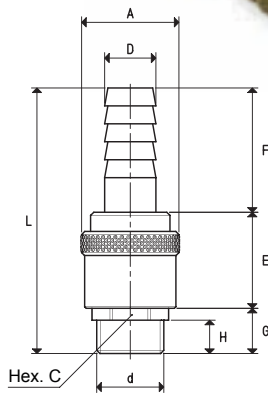
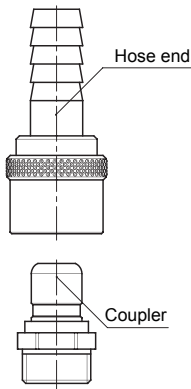

Art.	d	A	C	D	E	F	G	H	L	Material	Hose end	Hose end weight	Coupling	Coupling weight
											art.	g	art.	g
RR 3/8"	G3/8"	30	21	13	29.5	39.5	14	10.5	83.0	brass	00 RR 3/8 02	100	00 RR 3/8 01	38
RR 1/2"	G1/2"	30	21	16	30.5	38.5	14	10.5	83.0	brass	00 RR 1/2 02	104	00 RR 1/2 01	34
RR 3/4"	G3/4"	30	26	20	29.0	38.5	15	10.5	82.5	brass	00 RR 3/4 02	118	00 RR 3/4 01	50
RR 1"	G1"	38	34	25	30.0	40.0	17	12.0	87.0	brass	00 RR 1 02	166	00 RR 1 01	92
RR 1" 1/4	G1" 1/4	68	42	35	49.5	49.5	24	13.5	123.0	brass	00 RR 1 1/4 02	568	00 RR 1 1/4 01	210
RR 1" 1/2	G1" 1/2	68	48	40	49.0	54.0	25	17.0	128.0	brass	00 RR 1 1/2 02	710	00 RR 1 1/2 01	250

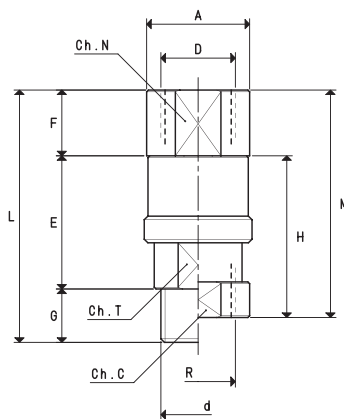
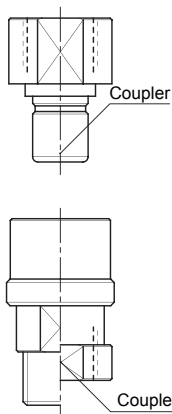

Art.	A	C	D	d	E	F	G	H	L	M	N	R	T	Material	Fitting	Fitting weight	Coupling	Coupling weight
															art.	g	art.	g
RRF 3/8"	23.5	--	G3/8"	G3/8"	36.5	20.0	15	--	71.5	--	22	--	22	brass	00 RRF 3/8 02	77	00 RRF 3/8 01	58
RRF 1/2"	29.0	--	G1/2"	G1/2"	37.5	18.5	15	--	71.0	--	26	--	22	brass	00 RRF 1/2 02	79	00 RRF 1/2 01	72
RRF 3/4"	37.0	--	G3/4"	G3/4"	41.0	20.0	15	--	76.0	--	34	--	28	brass	00 RRF 3/4 02	149	00 RRF 3/4 01	132
RRF 1"	48.0	--	G1"	G1"	56.5	19.5	16	--	92.0	--	43	--	43	brass	00 RRF 1 02	369	00 RRF 1 01	355
RRFF 3/8"	23.5	22	G3/8"	--	--	20.0	--	45	--	65	22	G3/8"	--	brass	00 RRFF 3/8 02	82	00 RRF 3/8 01	58
RRFF 1/2"	29.0	26	G1/2"	--	--	18.5	--	46	--	64.5	26	G1/2"	--	brass	00 RRFF 1/2 02	80	00 RRF 1/2 01	72
RRFF 3/4"	37.0	34	G3/4"	--	--	20.0	--	57	--	77	34	G3/4"	--	brass	00 RRFF 3/4 02	199	00 RRF 3/4 01	132
RRFF 1"	48.0	43	G1"	--	--	19.5	--	67	--	86.5	43	G1"	--	brass	00 RRFF 1 02	409	00 RRF 1 01	355

3D drawings available at www.vuototecnica.net

COMPRESSED AIR AND VACUUM FLEXIBLE HOSES



TPL flexible hoses are made with Polyamide 11 of vegetal derivation and are suited for compressed air and vacuum for internal diameters up to 9 mm, as well as for compressed air only.

They feature a good flexibility and lightness, a very low water absorption and excellent mechanical performance. They also feature an excellent resistance to low and high temperatures, chemical agents, pneumatic pressure and ageing.

Our TPR flexible hoses have been specially designed for vacuum and are composed of a single piece with plastic insulation and self-extinguishing materials, including the hose reinforcement core. Their excellent flexibility ensures minimal bending radius and are very light in relation to their great resistance to crushing.

Their smooth inside allows reducing harmful load losses to the minimum. The excellent functionality of these flexible hoses is associated with a high resistance to abrasion, to weather agents and most chemical products.

TPL flexible hose connection is ensured by the previously described fittings. As for TPR hoses, we have created a brand new range of RTPR fittings. RTPR fittings from 3/8" to 1" are made with self-extinguishing polypropylene, while the larger ones are made with nickel-plated metal. All the fittings are very sturdy and ensure a perfect vacuum seal. Moreover, these fittings do not require unpleasant hose clamps and make the connection much quicker and safer. They are available in various sizes according to the diameter of the hose to be connected.

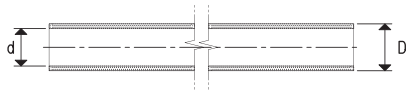

TPL HOSE

Art.	d Ø int.	D Ø ext.	Bending radius	Weight g/m	Package m	Material	Standard colour
TPL 2	2.5	4	20	8.0	100	polyamide 11	sky blue
TPL 4	4.0	6	30	19.5	100	polyamide 11	sky blue
TPL 6	6.0	8	40	20.5	100	polyamide 11	sky blue
TPL 8	8.0	10	60	24.0	100	polyamide 11	sky blue
TPL 9	9.0	12	70	28.0	50	polyamide 11	sky blue
TPL 12	12.0	15	95	67.0	50	polyamide 11	sky blue
TPL 16	16.0	18	130	56.0	50	polyamide 11	sky blue
TPL 18	18.0	22	300	133.0	50	polyamide 11	sky blue

Operating temperature: -40° / +70 °C

Other colours upon request

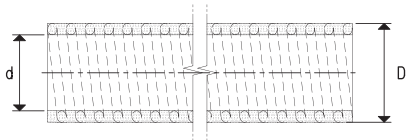

TPR HOSE

Art.	d Ø int.	D Ø ext.	Bending radius	Weight g/m	Package m	Material	Standard colour
TPR 3/8"	12.7	17.8	64	150	30	pvc	grey
TPR 1/2"	16.2	21.1	81	170	30	pvc	grey
TPR 3/4"	21.3	26.4	107	230	30	pvc	grey
TPR 1"	27.0	33.1	135	370	30	pvc	grey
TPR 1" 1/4	35.7	41.8	179	500	30	pvc	grey
TPR 1" 1/2	40.6	47.8	203	630	30	pvc	grey
TPR 2"	51.9	59.8	260	900	30	pvc	grey

Operating temperature: -10° / +60 °C

Conversion ratio: inch = $\frac{\text{mm}}{25.4}$; pounds = $\frac{\text{g}}{453.6} = \frac{\text{Kg}}{0.4536}$

TPR FLEXIBLE HOSE FITTINGS

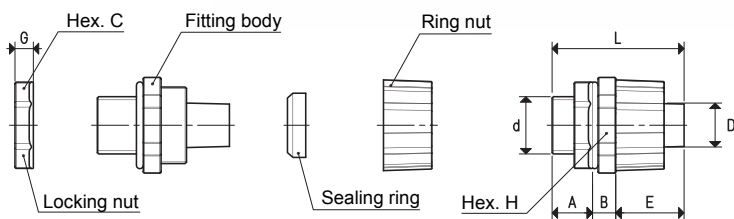

RTPR FITTINGS

Art.	d Ø	A	B	C	D Ø	E	G	H	L	Material	Colour	Weight g
RTPR 3/8"	G3/8"	14.5	8.5	26	12.0	23.5	6	28	46.5	polypropylene	grey	12
RTPR 1/2"	G1/2"	14.5	9.0	28	15.5	26.5	7	33	50.0	polypropylene	grey	18
RTPR 3/4"	G3/4"	14.0	10.5	35	20.8	26.5	9	38	51.0	polypropylene	grey	26
RTPR 1"	G1"	16.0	9.0	41	26.5	32.5	10	44	57.5	polypropylene	grey	36

Operating temperature: -10° / +60 °C

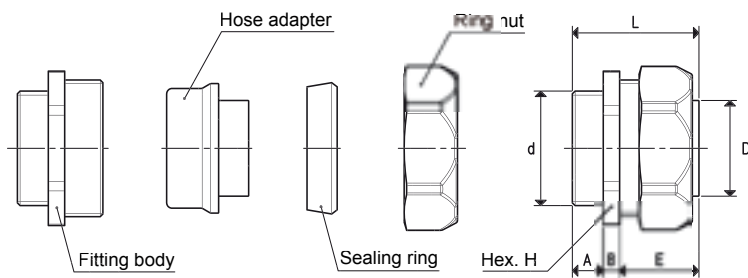

RTPR FITTINGS

Art.	d Ø	A	B	D Ø	E	H	L	Material	Weight g
RTPR 1" 1/4	G1" 1/4	11	6	34.5	28.5	52	45.5	nickel-plated brass	340
RTPR 1" 1/2	G1" 1/2	14	7	39.5	34.0	60	55.0	nickel-plated brass	530
RTPR 2"	G2"	14	7	50.0	33.0	74	54.0	nickel-plated brass	596

Operating temperature: -20° / +60 °C

3D drawings available at www.vuototecnica.net