

BALL VALVES

Application

- Used for controlling air supply in the opened and closed positions.

Feature

- Available for water as well as air with PPS resin body.
- The sectional dimension of the compact body optimizes as much flow as the tube capacity in proportion.

Specification

Fluid	Air & Water	
Working Pressure Range	0~150PSI	0~9Kgf/cm ² (0~900kPa)
Negative Pressure	-29.50 in Hg	-750mmHg(10Torr)
Temperature Range	32~140° F	0~60° C
Applicable Tube Material	Polyurethane and Nylon	



Product Code System

BC 20 - 08 02

① ② ③ ④

(1) Type
(2) Effective Sectional Area

	Metric Size	
Code	20	60
Size	20mm ²	60mm ²

(3) Tube Dia(∅D)

Code	06	08	10	12
Dia	∅6	∅8	∅10	∅12

(4) Thread Size(T)

	Taper Pipe Thread			
Code	01	02	03	04
Size	R1/8	R1/4	R3/8	R1/2

Structural Diagram

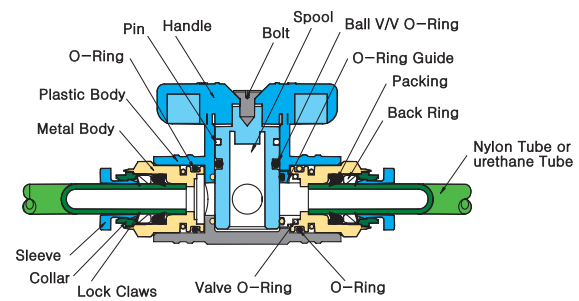

Ball Valves



Fitting with G Thread (O-Ring)



CAUTION

- Be sure to read the "Common Precautions" and "Using Precautions of Fitting Series"(P6) before using.
- Be sure to turn at a right angle(90°) when operating handle, otherwise it may cause the shortage of fluid.

WARNING

- When using with water, the pressure must not exceed 0~3kgf/cm². Be sure not to use in a place of vibration, bending, or shocking.
- Be sure to confirm that the Lock Pin is applied correctly. Without the Lock Pin, the body can be disassembled.

BUC

Union



MODEL [ØD-T]

Tube (Metric) - Thread(R)	
MODEL	ØD
BUC 20-0606	6
BUC 20-0808	8
BUC 60-1010	10
BUC 60-1212	12

Tube (Inch) - Thread (NPT)	
MODEL	ØD
BUC 20 1/4-1/4	1/4
BUC 20 5/16-5/16	5/16
BUC 60 3/8-3/8	3/8
BUC 60 1/2-1/2	1/2

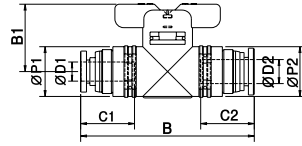

BM

Bulkhead Union



MODEL [ØD-T]

Tube (Metric) - Thread(R)	
MODEL	ØD
BM 20-0606	6
BM 20-0806	8
BM 20-0808	8
BM 60-1010	10
BM 60-1210	12
BM 60-1212	12

Tube (Inch) - Thread (NPT)	
MODEL	ØD
BM 20 1/4-1/4	1/4
BM 20 5/16-1/4	5/16
BM 20 5/16-5/16	5/16
BM 60 3/8-3/8	3/8
BM 60 1/2-3/8	1/2
BM 60 1/2-1/2	1/2

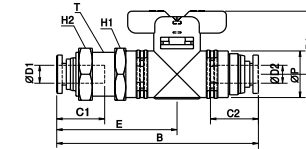

BUG

Reducing Union



MODEL [ØD1-T]

Tube (Metric) - Thread(R)		
MODEL	ØD1	ØD2
BUG 20-0806	8	6
BUG 60-1210	12	10

Tube (Inch) - Thread (NPT)		
MODEL	ØD1	ØD2
BUG 20 5/16-1/4	5/16	1/4
BUG 60 1/2-3/8	1/2	3/8

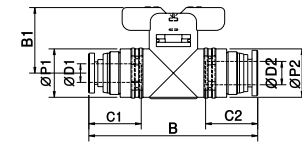

BL

Elbow

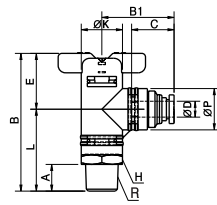

MODEL [ØD-T]

Tube (Metric) - Thread (R)

MODEL	ØD	R
BL 20-06-01	6	R1/8
BL 20-06-02	6	R1/4
BL 20-06-03	6	R3/8
BL 20-08-01	8	R1/8
BL 20-08-02	8	R1/4
BL 20-08-03	8	R3/8
BL 60-10-02	10	R1/4
BL 60-10-03	10	R3/8
BL 60-10-04	10	R1/2
BL 60-12-02	12	R1/4
BL 60-12-03	12	R3/8
BL 60-12-04	12	R1/2

Tube (Inch) - Thread (NPT)

MODEL	ØD	R
BL 20 1/4-N1/8	1/4	NPT1/8
BL 20 1/4-N1/4	1/4	NPT1/4
BL 20 1/4-N3/8	1/4	NPT3/8
BL 20 5/16-N1/8	5/16	NPT1/8
BL 20 5/16-N1/4	5/16	NPT1/4
BL 20 5/16-N3/8	5/16	NPT3/8
BL 60 3/8-N1/4	3/8	NPT1/4
BL 60 3/8-N3/8	3/8	NPT3/8
BL 60 3/8-N1/2	3/8	NPT1/2
BL 60 1/2-N1/4	1/2	NPT1/4
BL 60 1/2-N3/8	1/2	NPT3/8
BL 60 1/2-N1/2	1/2	NPT1/2

BL-G

Elbow

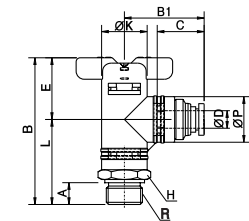

MODEL [ØD-T]

Tube (Metric) - Thread (G)

MODEL	ØD	R
BL 20-06G01	6	G1/8
BL 20-06G02	6	G1/4
BL 20-06G03	6	G3/8
BL 20-08G01	8	G1/8
BL 20-08G02	8	G1/4
BL 20-08G03	8	G3/8
BL 60-10G02	10	G1/4
BL 60-10G03	10	G3/8
BL 60-10G04	10	G1/2
BL 60-12G02	12	G1/4
BL 60-12G03	12	G3/8
BL 60-12G04	12	G1/2

BC

Straight

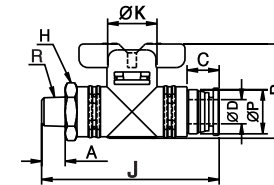

MODEL [ØD-T]

Tube (Metric) - Thread (R)

MODEL	ØD	R
BC 20-06-01	6	R1/8
BC 20-06-02	6	R1/4
BC 20-06-03	6	R3/8
BC 20-08-01	8	R1/8
BC 20-08-02	8	R1/4
BC 20-08-03	8	R3/8
BC 60-10-02	10	R1/4
BC 60-10-03	10	R3/8
BC 60-10-04	10	R1/2
BC 60-12-02	12	R1/4
BC 60-12-03	12	R3/8
BC 60-12-04	12	R1/2

Tube (Inch) - Thread (NPT)

MODEL	ØD	R
BC 20 1/4-N1/8	1/4	NPT1/8
BC 20 1/4-N1/4	1/4	NPT1/4
BC 20 1/4-N3/8	1/4	NPT3/8
BC 20 5/16-N1/8	5/16	NPT1/8
BC 20 5/16-N1/4	5/16	NPT1/4
BC 20 5/16-N3/8	5/16	NPT3/8
BC 60 3/8-N1/4	3/8	NPT1/4
BC 60 3/8-N3/8	3/8	NPT3/8
BC 60 3/8-N1/2	3/8	NPT1/2
BC 60 1/2-N1/4	1/2	NPT1/4
BC 60 1/2-N3/8	1/2	NPT3/8
BC 60 1/2-N1/2	1/2	NPT1/2

BC-G

Straight

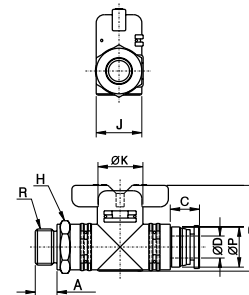

MODEL [ØD-T]

Tube (Metric) - Thread (G)

MODEL	ØD	R
BC 20-06G01	6	G1/8
BC 20-06G02	6	G1/4
BC 20-06G03	6	G3/8
BC 20-08G01	8	G1/8
BC 20-08G02	8	G1/4
BC 20-08G03	8	G3/8
BC 60-10G02	10	G1/4
BC 60-10G03	10	G3/8
BC 60-10G04	10	G1/2
BC 60-12G02	12	G1/4
BC 60-12G03	12	G3/8
BC 60-12G04	12	G1/2

BUL

Union Elbow



MODEL [ØD-T]

Tube (Metric) - Thread(R)	
MODEL	ØD
BUL 20-0606	6
BUL 20-0808	8
BUL 60-1010	10
BUL 60-1212	12

Tube (Inch) - Thread (NPT)	
MODEL	ØD
BUL 20 1/4-1/4	1/4
BUL 20 5/16-5/16	5/16
BUL 60 3/8-3/8	3/8
BUL 60 1/2-1/2	1/2

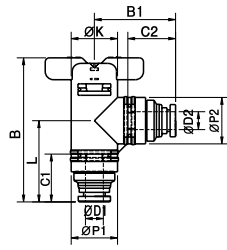

BLM

Bulkhead Union Elbow



MODEL [ØD-T]

Tube (Metric) - Thread(R)	
MODEL	ØD
BLM 20-0606	6
BLM 20-0806	8
BLM 20-0808	8
BLM 60-1010	10
BLM 60-1210	12
BLM 60-1212	12

Tube (Inch) - Thread (NPT)	
MODEL	ØD1
BLM 20 1/4-1/4	1/4
BLM 20 5/16-1/4	5/16
BLM 20 5/16-5/16	5/16
BLM 60 3/8-3/8	3/8
BLM 60 1/2-3/8	1/2
BLM 60 1/2-1/2	1/2

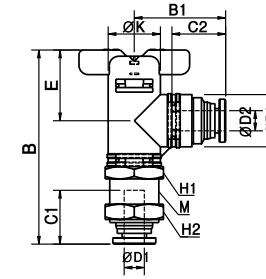

BLG

Reducing Union Elbow



MODEL [ØD1-T]

Tube (Metric) - Thread(R)		
MODEL	ØD1	ØD2
BLG 20-0608	6	8
BLG 20-0806	8	6
BLG 60-1012	10	12
BLG 60-1210	12	10

Tube (Inch) - Thread (NPT)		
MODEL	ØD1	ØD2
BLG 20 1/4-5/16	1/4	5/16
BLG 20 5/16-1/4	5/16	1/4
BLG 60 3/8-1/2	3/8	1/2
BLG 60 1/2-3/8	1/2	3/8

