

GU Safety



Innesti Rapidi di Sicurezza
Safety Couplings
Coupleurs de Sécurité
Sicherheitskupplungen



1	2	3	4	5	6	
GU 41	Innesto rapido a pulsante con dispositivo di sicurezza per profili ISO 6150 C-10		Push-button safety coupler according to ISO 6150 C-10	Coupleur securite a bouton selon profil ISO 6150 C-10		Sicherheitskupplung mit Knopf gemäss ISO 6150 C-10 profil
Corpo Body Corps Körper	Otturatore Valve Clapet Ventil	Vite Thread Filet Gewindestück	Pulsante Button Bouton Knopf	Guarnizioni Seals Joint d'étanchéité Dichtung	Molle Springs Ressorts Feder	Innesti Plugs Embouts Stecker
Alluminio Anodizzato Anodised Aluminium Aluminium anodisé Eloxiertes Aluminium	Ottone UNI EN 12164 CW614N Brass UNI EN 12164 CW614N Laiton UNI EN 12164 CW614N Messing UNI EN 12164 CW614N	Ottone nichelato UNI EN 12164 CW614N Brass nickel plated UNI EN 12164 CW614N Laiton nickelé UNI EN 12164 CW614N Messing vernickelt UNI EN 12164 CW614N	Acciaio Indurito e zincato Hardened, zinc plated steel Acier trempé et zingué Stahl gehärtet und verzinkt	NBR NBR NBR NBR	Acciaio Inox AISI 302 Stainless Steel AISI 302 Acier Inox AISI 302 Edelstahl AISI 302	Acciaio Indurito e zincato Hardened, zinc plated steel Acier trempé et zingué Stahl gehärtet und verzinkt

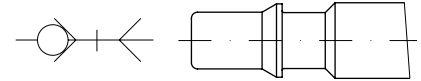
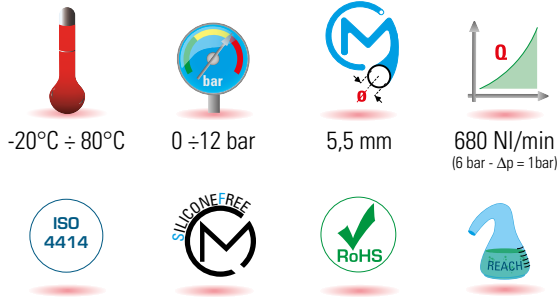

Profilo ISO 6150 C-10
ISO 6150 C-10 Profile
Profil ISO 6150 C-10
ISO 6150 C-10 Profil

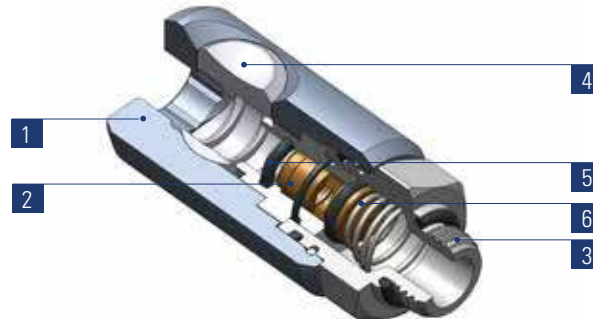

L'Innesto Rapido rimane orientabile anche dopo l'installazione.
The coupling will remain swivelling after installation.
Le coupleur peut être orienté après le montage.
Die Kupplung bleibt nach der Montage drehbar.

CONNESSIONE - DISCONNESSIONE	CONNECTION - TO RELEASE	CONNEXION - DECONNEXION	ZUM KUPPELN - ZUM ENTKUPPELN
------------------------------	-------------------------	-------------------------	------------------------------

Inserire semplicemente l'innesto nel corpo.

Insert the plug into the coupler

Insérer l'embout dans le coupleur pour accoupler les deux composants

Stecker in die Kupplung einstecken

Per la disconnessione dell'innesto dal corpo femmina è necessario seguire 2 semplici fasi:
L'innesto è inserito nel corpo femmina
Fase 1:
Premere il pulsante di sgancio permettendo così lo scarico dell'aria del circuito a valle; l'innesto in questa fase è ancora trattenuto all'interno del corpo femmina.
Fase 2:
Premere nuovamente il pulsante per rimuovere l'innesto dal corpo femmina.

To disconnect the plug follow instructions below:
Plug inserted in coupler
Step 1:
Press the button once to vent the downstream air from the circuit; at this time the plug is still captive in the coupling.
Step 2:
Press the button one more time to release the plug.

Pour sortir l'embout suivre les indications ci-dessous:
Embout inséré dans le coupleur
Phase 1:
Appuyer sur le bouton pour que la pression s'échappe du circuit. L'embout reste cependant encore dans le coupleur.
Phase 2:
Pour déconnecter l'embout, appuyer une deuxième fois sur le bouton.

Zum Entkuppeln, den folgen den Anweisungen folgen:
Der Stecker ist gekuppelt
Phase 1:
Auf dem Knopf einmal drücken. Dadurch wird die Anlage entlüftet dennoch bleibt der Stecker in der Kupplung gesichert.
Phase 2:
Erst bei einem zweiten Drücken auf dem Knopf wird der Stecker gelöst.



Zum Entkuppeln, den folgen den Anweisungen folgen:

GU 41-10

Innesto Rapido con filetto maschio

Male couplig

Coupleur mâle

Einschraubkupplung

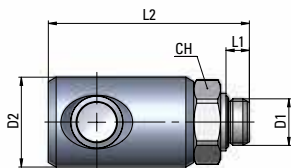

Tipo	D1	D2	L1	L2	CH	g Δ
10 00 14	G1/4	25	6,5	56	21	89,75
10 00 38	G3/8	25	7	56	21	91,02
10 00 12	G1/2	25	8,5	58,5	25	112,94

GU 41-12

Innesto Rapido con filetto femmina

Female couplig

Coupleur femelle

Aufschraubkupplung

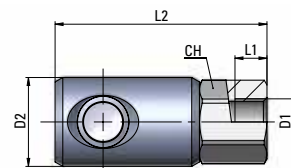

Tipo	D1	D2	L1	L2	CH	g Δ
12 00 14	G1/4	25	9	59,5	21	111,02
12 00 38	G3/8	25	10	61,5	21	107,71
12 00 12	G1/2	25	11	63,5	24	120

GU 41-13

Innesto Rapido con portagomma

Couplig with hose connection

Coupleur avec douille cannelée

Kupplung mit Schlauchtülle

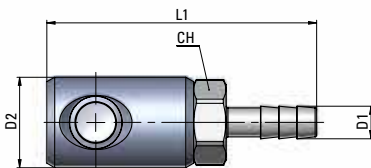

Tipo	Øi Tubo	D1	D2	L2	CH	g Δ
13 06 00	6	7	25	74,5	21	93,12
13 08 00	8	9	25	74,5	21	94,48
13 10 00	10	11	25	74,5	21	95,69

GU 41-20

Innesto con filetto maschio

Male plug

Embout mâle

Einschraubverschlußnippel

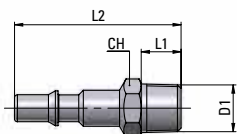

Tipo	D1	L1	L2	CH	g Δ
20 00 14	R1/4	11	46	14	18
20 00 38	R3/8	11,5	46,5	17	23,5
20 00 12	R1/2	14	49	22	36,5

GU 41-21

Innesto con filetto femmina

Female plug

Embout femelle

Aufschraubverschlußnippel

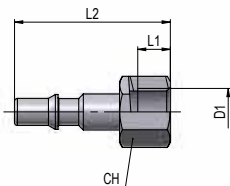

Tipo	D1	L1	L2	CH	g Δ
21 00 14	G1/4	10	43	17	23
21 00 38	G3/8	10	45	20	29
21 00 12	G1/2	11	47	24	41

GU 41-22

Innesto con portagomma

Plug with hose connection

Embout avec douille cannelée

Schlauchtülle

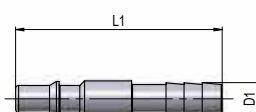

Tipo	Øi Tubo	D1	L1	g Δ
22 06 00	6	7	57	12,3
22 08 00	8	9	57	14,7
22 10 00	10	11	57	21,2

1	2	3	4	5	6	
GU 42	Innesto rapido a pulsante con dispositivo di sicurezza per profili ISO 6150 B-12	Push-button safety coupler according to ISO 6150 B-12	Coupleur securite a bouton selon profil ISO 6150 B-12	Sicherheitskupplung mit Knopf gemäss ISO 6150 B-12 profil		
Corpo Body Corps Körper	Pulsante, Otturatore e ghiera di scarico Button, Valve and Venting ring Bouton, Clapet et Bague d'échappement Knopf, Ventil und Entlüftungsring	Vite Thread Filet Gewindestück	Molle Springs Ressorts Feder	Sfere Balls Billes Kugel	Guarnizioni Seals Joint d'étanchéité Dichtung	Innesti Plugs Embouts Stecker
Alluminio Anodizzato Anodised Aluminium Aluminium anodisé Eloxiertes Aluminium	Acciaio Indurito e zincato Hardened, zinc plated steel Acier trempé et zingué Stahl gehärtet und verzinkt	Ottone nichelato UNI EN 12164 CW614N Brass nickel plated UNI EN 12164 CW614N Laiton nickelé UNI EN 12164 CW614N Messing vernickelt UNI EN 12164 CW614N	Acciaio Inox AISI 302 Stainless Steel AISI 302 Acier Inox AISI 302 Edelstahl AISI 302	Acciaio Inox AISI 420 Stainless Steel AISI 420 Acier Inox AISI 420 Edelstahl AISI 420	NBR NBR NBR NBR	Acciaio Indurito e zincato Hardened, zinc plated steel Acier trempé et zingué Stahl gehärtet und verzinkt

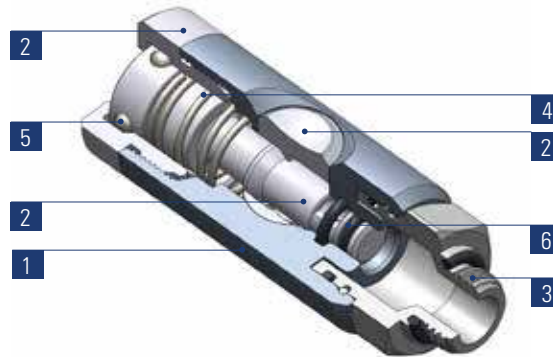

i L'Innesto Rapido rimane orientabile anche dopo l'installazione.
The coupler will remain swivelling after installation.
Le coupleur peut être orienté après le montage.
Die Kupplung bleibt nach der Montage drehbar.

CONNESSIONE - DISCONNESSIONE	CONNECTION - TO RELEASE	CONNEXION - DECONNEXION	ZUM KUPPELN - ZUM ENTKUPPELN
Inserire semplicemente l'innesto nel corpo.	Insert the plug into the coupler	Insérer l'embout dans le coupleur pour accoupler les deux composants	Stecker in die Kupplung einstecken
Per la disconnessione dell'innesto dal corpo femmina è necessario seguire 2 semplici fasi: L'innesto è inserito nel corpo femmina Fase 1: Premere il pulsante di sgancio permettendo così lo scarico dell'aria del circuito a valle; l'innesto in questa fase è ancora trattenuto all'interno del corpo femmina. Fase 2: Premere nuovamente il pulsante per rimuovere l'innesto dal corpo femmina.	To disconnect the plug follow instructions below: Plug inserted in coupler Step 1: Press the button once to vent the downstream air from the circuit; at this time the plug is still captive in the coupling. Step 2: Press the button one more time to release the plug.	Pour sortir l'embout suivre les indications ci-dessous: Embout inséré dans le coupleur Phase 1: Appuyer sur le bouton pour que la pression s'échappe du circuit. L'embout reste cependant encore dans le coupleur. Phase 2: Pour déconnecter l'embout, appuyer une deuxième fois sur le bouton.	Zum Entkuppeln, den folgen den Anweisungen folgen: Der Stecker ist gekuppelt Phase 1: Auf dem Knopf einmal drücken. Dadurch wird die Anlage entlüftet dennoch bleibt der Stecker in der Kupplung gesichert. Phase 2: Erst bei einem zweiten Drücken auf dem Knopf wird der Stecker gelöst.



GU 42-10

Innesto Rapido con filetto maschio

Male couplig

Coupleur mâle

Einschraubkupplung

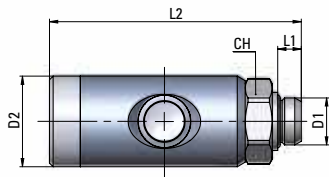

Tipo	D1	D2	L1	L2	CH	g $\Delta\Delta$
10 00 14	G1/4	25	6,5	69,5	21	116,95
10 00 38	G3/8	25	7	69,5	21	118,28
10 00 12	G1/2	25	8,5	72	25	140,38

GU 42-12

Innesto Rapido con filetto femmina

Female couplig

Coupleur femelle

Aufschraubkupplung

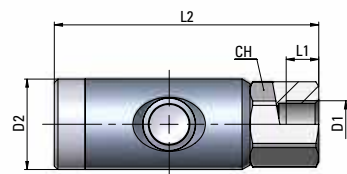

Tipo	D1	D2	L1	L2	CH	g $\Delta\Delta$
12 00 14	G1/4	25	9	73	21	138,22
12 00 38	G3/8	25	10	75	21	134,91
12 00 12	G1/2	25	11	77	24	147,19

GU 42-13

Innesto Rapido con portagomma

Couplig with hose connection

Coupleur avec douille cannelée

Kupplung mit Schlauchtülle

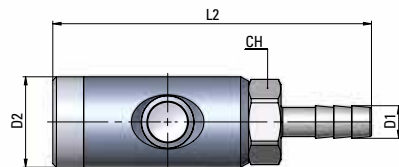

Tipo	Øi Tubo	D1	D2	L2	CH	g $\Delta\Delta$
13 06 00	6	7	25	88	21	120,32
13 08 00	8	9	25	88	21	121,68
13 10 00	10	11	25	88	21	122,88

GU 42-20

Innesto con filetto maschio

Male plug

Embout mâle

Einschraubverschußnippel

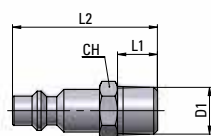

Tipo	D1	L1	L2	CH	g $\Delta\Delta$
20 00 14	R1/4	11	40	14	20
20 00 38	R3/8	11,5	41,5	17	26
20 00 12	R1/2	14	44	22	40

GU 42-21

Innesto con filetto femmina

Female plug

Embout femelle

Aufschraubverschußnippel

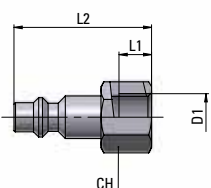

Tipo	D1	L1	L2	CH	g $\Delta\Delta$
21 00 14	G1/4	10	38	17	25
21 00 38	G3/8	11	40	20	31,5
21 00 12	G1/2	11	42	24	43,5

1	2	3	4	5	6	
GU 43	Innesto rapido a pulsante con dispositivo di sicurezza per profili ISO 6150 C-14		Push-button safety coupler according to ISO 6150 C-14	Coupleur securite a bouton selon profil ISO 6150 C-14		Sicherheitskupplung mit Knopf gemäss ISO 6150 C-14 profil
Corpo Body Corps Körper	Otturatore Valve Clapet Ventil	Vite Thread Filet Gewindestück	Pulsante Button Bouton Knopf	Guarnizioni Seals Joint d'étanchéité Dichtung	Molle Springs Ressorts Feder	Innesti Plugs Embouts Stecker
Alluminio Anodizzato Anodised Aluminium Aluminium anodisé Eloxiertes Aluminium	Ottone UNI EN 12164 CW614N Brass UNI EN 12164 CW614N Laiton UNI EN 12164 CW614N Messing UNI EN 12164 CW614N	Ottone nichelato UNI EN 12164 CW614N Brass nickel plated UNI EN 12164 CW614N Laiton nickelé UNI EN 12164 CW614N Messing vernickelt UNI EN 12164 CW614N	Acciaio Indurito e zincato Hardened, zinc plated steel Acier trempé et zingué Stahl gehärtet und verzinkt	NBR NBR NBR NBR	Acciaio Inox AISI 302 Stainless Steel AISI 302 Acier Inox AISI 302 Edelstahl AISI 302	Acciaio Indurito e zincato Hardened, zinc plated steel Acier trempé et zingué Stahl gehärtet und verzinkt

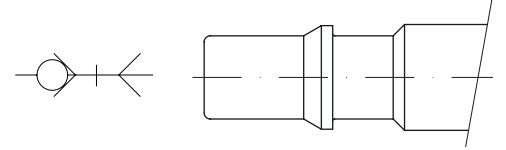
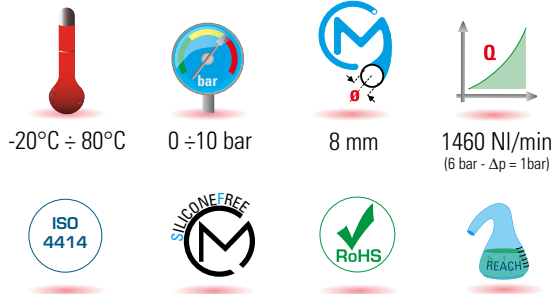

Profilo ISO 6150 C-14
ISO 6150 C-14 Profile
Profil ISO 6150 C-14
ISO 6150 C-14 Profil

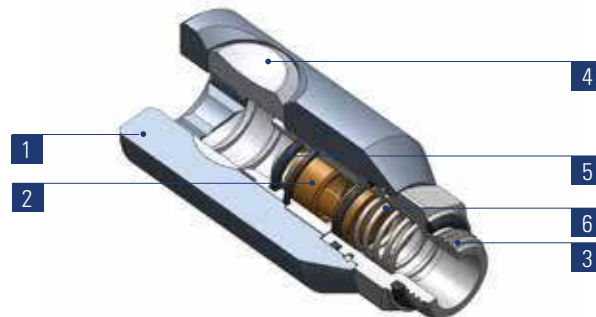

L'Innesto Rapido rimane orientabile anche dopo l'installazione.
The coupler will remain swivelling after installation.
Le coupleur peut être orienté après le montage.
Die Kupplung bleibt nach der Montage drehbar.

CONNESSIONE - DISCONNESSIONE	CONNECTION - TO RELEASE	CONNEXION - DECONNEXION	ZUM KUPPELN - ZUM ENTKUPPELN
------------------------------	-------------------------	-------------------------	------------------------------

Inserire semplicemente l'innesto nel corpo.

Insert the plug into the coupler

Insérer l'embout dans le coupleur pour accoupler les deux composants

Stecker in die Kupplung einstecken

Per la disconnessione dell'innesto dal corpo femmina è necessario seguire 2 semplici fasi:
L'innesto è inserito nel corpo femmina
Fase 1:
Premere il pulsante di sgancio permettendo così lo scarico dell'aria del circuito a valle; l'innesto in questa fase è ancora trattenuto all'interno del corpo femmina.
Fase 2:
Premere nuovamente il pulsante per rimuovere l'innesto dal corpo femmina.

To disconnect the plug follow instructions below:
Plug inserted in coupler
Step 1:
Press the button once to vent the downstream air from the circuit; at this time the plug is still captive in the coupling.
Step 2:
Press the button one more time to release the plug.

Pour sortir l'embout suivre les indications ci-dessous:
Embout inséré dans le coupleur
Phase 1:
Appuyer sur le bouton pour que la pression s'échappe du circuit. L'embout reste cependant encore dans le coupleur.
Phase 2:
Pour déconnecter l'embout, appuyer une deuxième fois sur le bouton.

Zum Entkuppeln, den folgen den Anweisungen folgen:
Der Stecker ist gekuppelt
Phase 1:
Auf dem Knopf einmal drücken. Dadurch wird die Anlage entlüftet dennoch bleibt der Stecker in der Kupplung gesichert.
Phase 2:
Erst bei einem zweiten Drücken auf dem Knopf wird der Stecker gelöst.



GU 43-10

Innesto Rapido con filetto maschio

Male couplig

Coupleur mâle

Einschraubkupplung

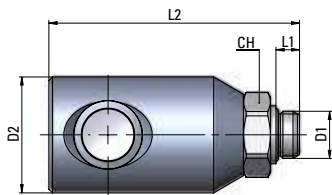

Tipo	D1	D2	L1	L2	CH	g Δ
10 00 14	G1/4	32	6,5	69	21	149,2
10 00 38	G3/8	32	7	69	21	150,54
10 00 12	G1/2	32	8,5	72	25	172,63

GU 43-12

Innesto Rapido con filetto femmina

Female couplig

Coupleur femelle

Aufschraubkupplung

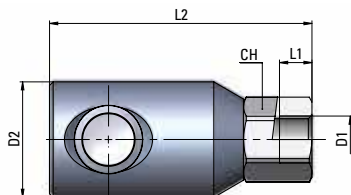

Tipo	D1	D2	L1	L2	CH	g Δ
12 00 14	G1/4	32	9	73	21	170,47
12 00 38	G3/8	32	10	75	21	167,16
12 00 12	G1/2	32	11	77	24	179,45

GU 43-13

Innesto Rapido con portagomma

Couplig with hose connection

Coupleur avec douille cannelée

Kupplung mit Schlauchtülle

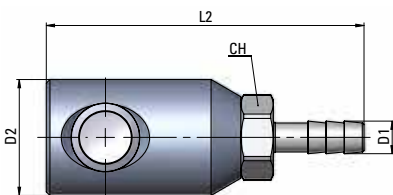

Tipo	Øi Tubo	D1	D2	L2	CH	g Δ
13 08 00	8	9	32	88	21	153,93
13 10 00	10	11	32	88	21	155,14
13 13 00	13	14	32	88	21	162,2

GU 43-20

Innesto con filetto maschio

Male plug

Embout mâle

Einschraubverschlußnippel

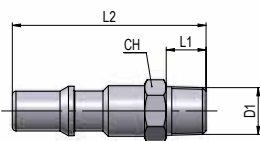

Tipo	D1	L1	L2	CH	g Δ
20 00 14	R1/4	11	53,5	15	32
20 00 38	R3/8	11,5	54	17	35,5
20 00 12	R1/2	14	56,5	22	51

GU 43-21

Innesto con filetto femmina

Female plug

Embout femelle

Aufschraubverschlußnippel

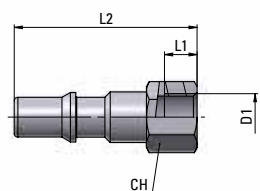

Tipo	D1	L1	L2	CH	g Δ
21 00 14	G1/4	10	50,5	17	35
21 00 38	G3/8	11	52,5	20	42
21 00 12	G1/2	11	54,5	24	53

GU 43-22

Innesto con portagomma

Plug with hose connection

Embout avec douille cannelée

Schlauchtülle

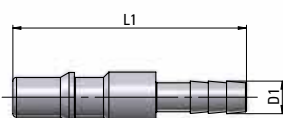

Tipo	Øi Tubo	D1	L1	g Δ
22 08 00	8	9	64,5	26,5
22 10 00	10	11	64,5	27
22 13 00	13	14	64,5	39

GU 44		Innesto rapido a pulsante con dispositivo di sicurezza per profilo ISO 6150 B-15	Push-button safety coupler according to ISO 6150 B-15	Coupleur securite a bouton selon profil ISO 6150 B-15	Sicherheitskupplung mit Knopf gemäss ISO 6150 B-15 profil	
1	2	3	4	5	6	
Corpo Body Corps Körper	Pulsante, Otturatore e ghiera di scarico Button, Valve and Venting ring Bouton, Clapet et Bague d'échappement Knopf, Ventil und Entlüftungsring	Vite Thread Filet Gewindestück	Molle Springs Ressorts Feder	Sfere Balls Billes Kugel	Guarnizioni Seals Joint d'étanchéité Dichtung	Innesti Plugs Embouts Stecker
Alluminio Anodizzato Anodised Aluminium Aluminium anodisé Eloxiertes Aluminium	Acciaio Indurito e zincato Hardened, zinc plated steel Acier trempé et zingué Stahl gehärtet und verzinkt	Ottone nichelato UNI EN 12164 CW614N Brass nickel plated UNI EN 12164 CW614N Laiton nickelé UNI EN 12164 CW614N Messing vernickelt UNI EN 12164 CW614N	Acciaio Inox AISI 302 Stainless Steel AISI 302 Acier Inox AISI 302 Edelstahl AISI 302	Acciaio Inox AISI 420 Stainless Steel AISI 420 Acier Inox AISI 420 Edelstahl AISI 420	NBR NBR NBR NBR	Acciaio Indurito e zincato Hardened, zinc plated steel Acier trempé et zingué Stahl gehärtet und verzinkt

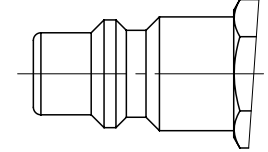
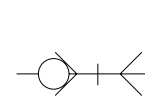

Profilo ISO 6150 B-15
ISO 6150 B-15 Profile
Profil ISO 6150 B-15
ISO 6150 B-15 Profil

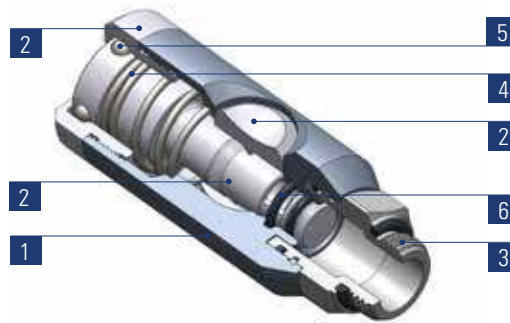

L'Innesto Rapido rimane orientabile anche dopo l'installazione.
The coupling will remain swivelling after installation.
Le coupleur peut être orienté après le montage.
Die Kupplung bleibt nach der Montage drehbar.

CONNESSIONE - DISCONNESSIONE	CONNECTION - TO RELEASE	CONNEXION - DECONNEXION	ZUM KUPPELN - ZUM ENTKUPPELN
------------------------------	-------------------------	-------------------------	------------------------------

Inserire semplicemente l'innesto nel corpo.

Insert the plug into the coupler

Insérer l'embout dans le coupleur pour accoupler les deux composants

Stecker in die Kupplung einstecken

Per la disconnessione dell'innesto dal corpo femmina è necessario seguire 2 semplici fasi:
L'innesto è inserito nel corpo femmina
Fase 1:
Premere il pulsante di sgancio permettendo così lo scarico dell'aria del circuito a valle; l'innesto in questa fase è ancora trattenuto all'interno del corpo femmina.
Fase 2:
Premere nuovamente il pulsante per rimuovere l'innesto dal corpo femmina.

To disconnect the plug follow instructions below:
Plug inserted in coupler
Step 1:
Press the button once to vent the downstream air from the circuit; at this time the plug is still captive in the coupling.
Step 2:
Press the button one more time to release the plug.

Pour sortir l'embout suivre les indications ci-dessous:
Embout inséré dans le coupleur
Phase 1:
Appuyer sur le bouton pour que la pression s'échappe du circuit. L'embout reste cependant encore dans le coupleur.
Phase 2:
Pour déconnecter l'embout, appuyer une deuxième fois sur le bouton.

Zum Entkuppeln, den folgen den Anweisungen folgen:
Der Stecker ist gekuppelt
Phase 1:
Auf dem Knopf einmal drücken. Dadurch wird die Anlage entlüftet dennoch bleibt der Stecker in der Kupplung gesichert.
Phase 2:
Erst bei einem zweiten Drücken auf dem Knopf wird der Stecker gelöst.



GU 44-10

Innesto Rapido con filetto maschio

Male couplig

Coupleur mâle

Einschraubkupplung

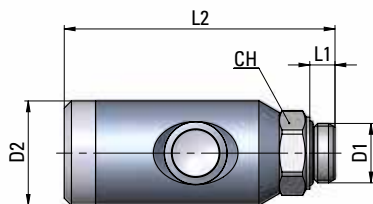

Tipo	D1	D2	L1	L2	CH	g $\Delta\Delta$
10 00 38	G3/8	29	7	75	21	150,78
10 00 12	G1/2	29	8,5	78	25	172,57

GU 44-12

Innesto Rapido con filetto femmina

Female couplig

Coupleur femelle

Aufschraubkupplung

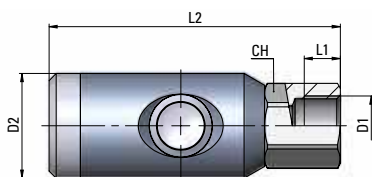

Tipo	D1	D2	L1	L2	CH	g $\Delta\Delta$
12 00 38	G3/8	29	10	81	21	167,1
12 00 12	G1/2	29	11	83	24	179,39

GU 44-13

Innesto Rapido con portagomma

Couplig with hose connection

Coupleur avec douille cannelée

Kupplung mit Schlauchtülle

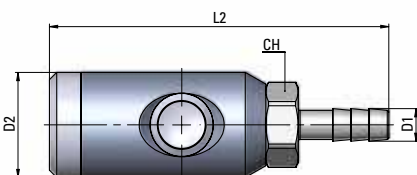

Tipo	Øi Tubo	D1	D2	L2	CH	g $\Delta\Delta$
13 08 00	8	9	29	94	21	1574,38
13 10 00	10	11	29	94	21	155,08
13 13 00	13	14	29	94	21	162,15

GU 44-20

Innesto con filetto maschio

Male plug

Embout mâle

Einschraubverschußnippel

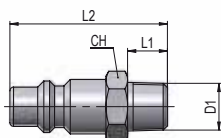

Tipo	D1	L1	L2	CH	g $\Delta\Delta$
20 00 14	R1/4	11	43,5	17	33,65
20 00 38	R3/8	11,5	44	17	34,76
20 00 12	R1/2	14	46,5	22	50,3

GU 44-21

Innesto con filetto femmina

Female plug

Embout femelle

Aufschraubverschußnippel

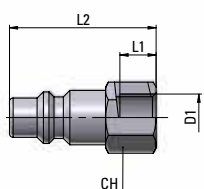

Tipo	D1	L1	L2	CH	g $\Delta\Delta$
21 00 14	G1/4	10	40,5	17	33,72
21 00 38	G3/8	11	42,5	20	40,6
21 00 12	G1/2	11	44,5	24	52,3

1	2	3	4	5	6	
GU 45	Innesto rapido a pulsante con dispositivo di sicurezza per profilo ARO 210		Push-button safety coupler according to ARO 210	Coupleur securite a bouton selon profil ARO 210	Sicherheitskupplung mit Knopf gemäss ARO 210 profil	
Corpo Body Corps Körper	Pulsante, Otturatore e ghiera di scarico Button, Valve and Venting ring Bouton, Clapet et Bague d'échappement Knopf, Ventil und Entlüftungsring	Vite Thread Filet Gewindestück	Molle Springs Ressorts Feder	Sfere Balls Billes Kugel	Guarnizioni Seals Joint d'étanchéité Dichtung	Innesti Plugs Embouts Stecker
Alluminio Anodizzato Anodised Aluminium Aluminium anodisé Eloxiertes Aluminium	Acciaio Indurito e zincato Hardened, zinc plated steel Acier trempé et zingué Stahl gehärtet und verzinkt	Ottone nichelato UNI EN 12164 CW614N Brass nickel plated UNI EN 12164 CW614N Laiton nickelé UNI EN 12164 CW614N Messing vernickelt UNI EN 12164 CW614N	Acciaio Inox AISI 302 Stainless Steel AISI 302 Acier Inox AISI 302 Edelstahl AISI 302	Acciaio Inox AISI 420 Stainless Steel AISI 420 Acier Inox AISI 420 Edelstahl AISI 420	NBR NBR NBR NBR	Acciaio Nichelato Nickel plated steel Acier Nickelé Stahl Vernickelt

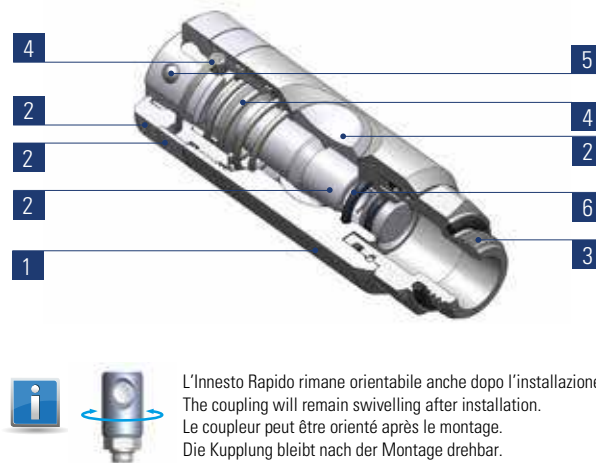

CONNESSIONE - DISCONNESSIONE	CONNECTION - TO RELEASE	CONNEXION - DECONNEXION	ZUM KUPPELN - ZUM ENTKUPPELN
Inserire semplicemente l'innesto nel corpo.	Insert the plug into the coupler	Insérer l'embout dans le coupleur pour accoupler les deux composants	Stecker in die Kupplung einstecken
Per la disconnessione dell'innesto dal corpo femmina è necessario seguire 2 semplici fasi: L'innesto è inserito nel corpo femmina Fase 1: Premere il pulsante di sgancio permettendo così lo scarico dell'aria del circuito a valle; l'innesto in questa fase è ancora trattenuto all'interno del corpo femmina. Fase 2: Premere nuovamente il pulsante per rimuovere l'innesto dal corpo femmina.	To disconnect the plug follow instructions below: Plug inserted in coupler Step 1: Press the button once to vent the downstream air from the circuit; at this time the plug is still captive in the coupling. Step 2: Press the button one more time to release the plug.	Pour sortir l'embout suivre les indications ci-dessous: Embout inséré dans le coupleur Phase 1: Appuyer sur le bouton pour que la pression s'échappe du circuit. L'embout reste cependant encore dans le coupleur. Phase 2: Pour déconnecter l'embout, appuyer une deuxième fois sur le bouton.	Zum Entkuppeln, den folgen den Anweisungen folgen: Der Stecker ist gekuppelt Phase 1: Auf dem Knopf einmal drücken. Dadurch wird die Anlage entlüftet dennoch bleibt der Stecker in der Kupplung gesichert. Phase 2: Erst bei einem zweiten Drücken auf dem Knopf wird der Stecker gelöst.



GU 45-10

Innesto Rapido con filetto maschio

Male couplig

Coupleur mâle

Einschraubkupplung

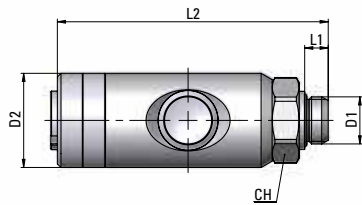

Tipo	D1	D2	L1	L2	CH	g $\Delta\Delta$
10 00 14	G1/4	26	6,5	75	21	144,84
10 00 38	G3/8	26	7	75	21	146,17
10 00 12	G1/2	26	8,5	77,5	25	168,27

GU 45-12

Innesto Rapido con filetto femmina

Female couplig

Coupleur femelle

Aufschraubkupplung

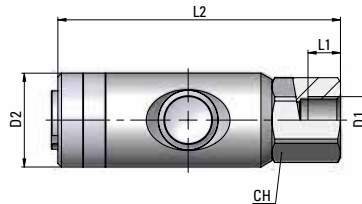

Tipo	D1	D2	L1	L2	CH	g $\Delta\Delta$
12 00 14	G1/4	26	9	78,5	21	166,11
12 00 38	G3/8	26	10	80,5	21	162,8
12 00 12	G1/2	26	11	82,5	24	175,08

GU 45-13

Innesto Rapido con portagomma

Couplig with hose connection

Coupleur avec douille cannelée

Kupplung mit Schlauchtülle

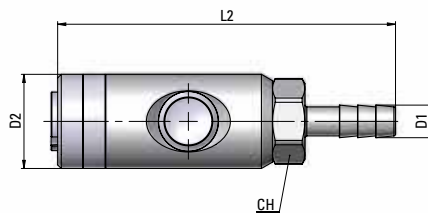

Tipo	Øi Tubo	D1	D2	L2	CH	g $\Delta\Delta$
13 06 00	6	7	26	93,5	21	148,21
13 08 00	8	9	26	93,5	21	149,57
13 09 00	9	10	26	93,5	21	150,19
13 10 00	10	11	26	93,5	21	150,77
13 13 00	13	14	26	93,5	21	157,84

GU 45-20

Innesto con filetto maschio

Male plug

Embout mâle

Einschraubverschlußnippel

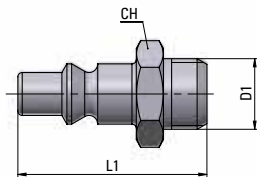

Tipo	D1	L1	CH	g $\Delta\Delta$
20 00 14	G1/4	36	14	17,13
20 00 38	G3/8	40	17	23,51
20 00 12	G1/2	39,5	24	41,25

GU 45-21

Innesto con filetto femmina

Female plug

Embout femelle

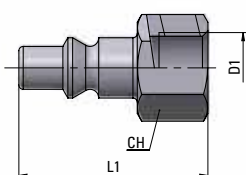

Aufschraubverschlußnippel

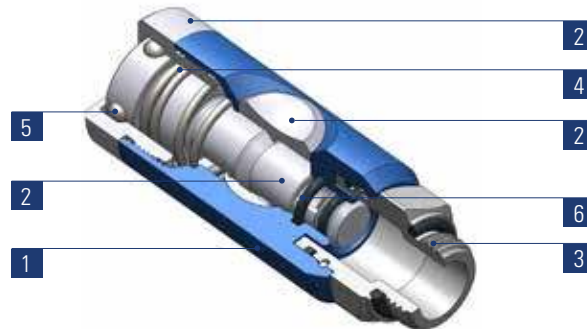

Tipo	D1	L1	CH	g $\Delta\Delta$
21 00 14	G1/4	37	16	18,95
21 00 38	G3/8	40	19	25,34
21 00 12	G1/2	43,5	25	50,39

1	2	3	4	5	6		
GU 46	Innesto rapido a pulsante con dispositivo di sicurezza per profilo europeo		Push-button safety coupler according european profile		Coupleur securite a bouton selon profil européen		Sicherheitskupplung mit Knopf gemäss europäisches profil
Corpo Body Corps Körper	Pulsante, Otturatore e ghiera di scarico Button, Valve and Venting ring Bouton, Clapet et Bague d'échappement Knopf, Ventil und Entlüftungsring	Vite Thread Filet Gewindestück	Molle Springs Ressorts Feder	Sfere Balls Billes Kugel	Guarnizioni Seals Joint d'étanchéité Dichtung	Innesti Plugs Embouts Stecker	
Alluminio Anodizzato Anodised Aluminium Aluminium anodisé Eloxiertes Aluminium	Acciaio Indurito e zincato Hardened, zinc plated steel Acier trempé et zingué Stahl gehärtet und verzinkt	Ottone nichelato UNI EN 12164 CW614N Brass nickel plated UNI EN 12164 CW614N Laiton nickelé UNI EN 12164 CW614N Messing vernickelt UNI EN 12164 CW614N	Acciaio Inox AISI 302 Stainless Steel AISI 302 Acier Inox AISI 302 Edelstahl AISI 302	Acciaio Inox AISI 420 Stainless Steel AISI 420 Acier Inox AISI 420 Edelstahl AISI 420	NBR NBR NBR NBR	Acciaio Indurito e zincato Hardened, zinc plated steel Acier trempé et zingué Stahl gehärtet und verzinkt	



  L'Innesto Rapido rimane orientabile anche dopo l'installazione.
The coupler will remain swivelling after installation.
Le coupleur peut être orienté après le montage.
Die Kupplung bleibt nach der Montage drehbar.

CONNESSIONE - DISCONNESSIONE	CONNECTION - TO RELEASE	CONNEXION - DECONNEXION	ZUM KUPPELN - ZUM ENTKUPPELN
------------------------------	-------------------------	-------------------------	------------------------------

Inserire semplicemente l'innesto nel corpo.

Insert the plug into the coupler

Insérer l'embout dans le coupleur pour accoupler les deux composants

Stecker in die Kupplung einstecken

Per la disconnessione dell'innesto dal corpo femmina è necessario seguire 2 semplici fasi:
L'innesto è inserito nel corpo femmina
Fase 1:
Premere il pulsante di sgancio permettendo così lo scarico dell'aria del circuito a valle; l'innesto in questa fase è ancora trattenuto all'interno del corpo femmina.
Fase 2:
Premere nuovamente il pulsante per rimuovere l'innesto dal corpo femmina.

To disconnect the plug follow instructions below:
Plug inserted in coupler
Step 1:
Press the button once to vent the downstream air from the circuit; at this time the plug is still captive in the coupling.
Step 2:
Press the button one more time to release the plug.

Pour sortir l'embout suivre les indications ci-dessous:
Embout inséré dans le coupleur
Phase 1:
Appuyer sur le bouton pour que la pression s'échappe du circuit. L'embout reste cependant encore dans le coupleur.
Phase 2:
Pour déconnecter l'embout, appuyer une deuxième fois sur le bouton.

Zum Entkuppeln, den folgen den Anweisungen folgen:
Der Stecker ist gekuppelt
Phase 1:
Auf dem Knopf einmal drücken. Dadurch wird die Anlage entlüftet dennoch bleibt der Stecker in der Kupplung gesichert.
Phase 2:
Erst bei einem zweiten Drücken auf dem Knopf wird der Stecker gelöst.



GU 46-10

Innesto Rapido con filetto maschio

Male couplig

Coupleur mâle

Einschraubkupplung

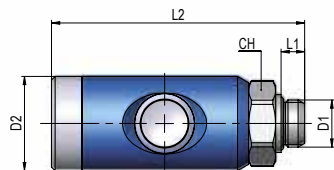

Tipo	D1	D2	L1	L2	CH	g $\Delta\Delta$
10 00 14	G1/4	26	6,5	70	21	123,69
10 00 38	G3/8	26	7	70	21	125,02
10 00 12	G1/2	26	8,5	72,5	25	147,12

GU 46-12

Innesto Rapido con filetto femmina

Female couplig

Coupleur femelle

Aufschraubkupplung

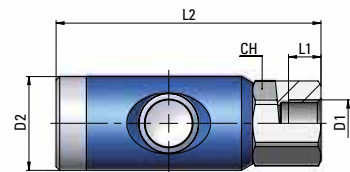

Tipo	D1	D2	L1	L2	CH	g $\Delta\Delta$
12 00 14	G1/4	26	9	73,5	21	144,96
12 00 38	G3/8	26	10	75,5	21	141,65
12 00 12	G1/2	26	11	77,5	24	153,93

GU 46-13

Innesto Rapido con portagomma

Couplig with hose connection

Coupleur avec douille cannelée

Kupplung mit Schlauchtülle

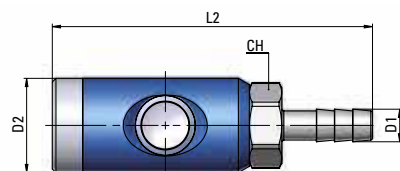

Tipo	Øi Tubo	D1	D2	L2	CH	g $\Delta\Delta$
13 06 00	6	7	26	88,5	21	127,06
13 08 00	8	9	26	88,5	21	128,42
13 09 00	9	10	26	88,5	21	128,17
13 10 00	10	11	26	88,5	21	129,62
13 13 00	13	14	26	88,5	21	135,82

Per gli Innesti da utilizzare si veda la relativa sezione della **serie GU26**.

For further info on the plugs to use, please revert to the **GU26 section**.

Pour autres renseignements concernant les embouts à utiliser, voir la **section des GU26**.

Bei weiteren Auskünften über die einsetzbaren Stecker, bitte sich auf den Abschnitt über **GU26** beziehen.