

**Rotary actuator SM4**  
Hydraulic / 250 bar

[ GATEWAY  
to new technologies. ]

**from 20 bar economically applicable**

- through precise combined helical gears and low friction seals, is the SM4 already from 20 bar economically applicable

**low hydraulic axial load on drive shaft****through small differential**

- less load on the four-point bearing, freeing it for more important tasks
- extending the service life of the rotary actuator

**adjustable drive shaft datum**

- if you manufacture the hub, it is not necessary to regard the exact position of the keyways.
- the total angle can be re-adjusted at any time

**four-point bearing**

- perfectly suited to withstand even extreme radial and axial loads, meeting the toughest requirements

**modern sealing technology**

- extended service life of seals
- increased safety, also with regard to the environment
- suitable for most fluids
- all o-rings featuring anti-extrusion back-up rings
- no internal leakages through solid seals enabling the load to be held in any intermediate position

**250 bar operating pressure**

- high performance in a very compact unit resulting in space and cost savings
- increased safety margin
- savings on accessories as only few applications will require pressure reducing valves to protect the SM4

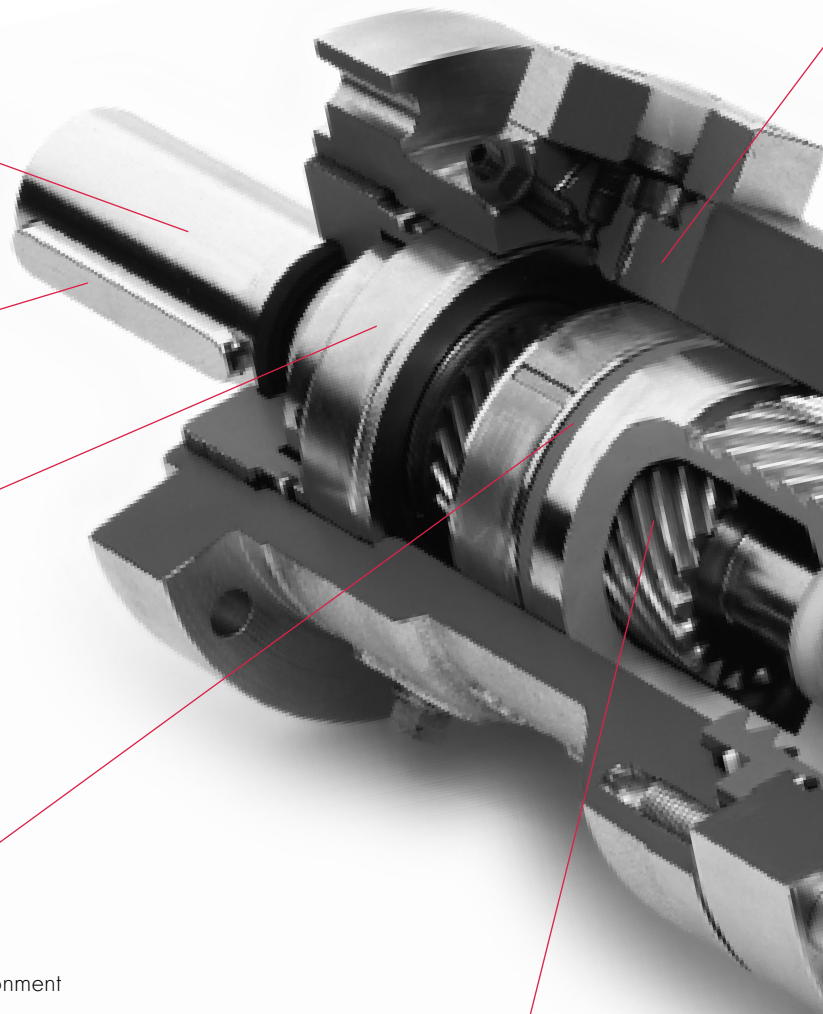
**wear-resistant moving parts**

- long service life of the rotary actuator through extended-period nitriding
- excellent sliding characteristics of the gears

## highly perfected end cushioning for absorption of kinetic energy

- negating the need for expensive proportional or servo controls with virtually identical characteristics

## large-area press-fit joint

- assuring positive power/torque transmission even at peak load conditions

## ... over time

- short delivery times through flexible storage
- individual solutions for your product
- quality assurance according to DIN EN ISO 9001

## externally adjustable end stop (standard)

- the end angle can be re-adjusted at any time by  $\pm 5^\circ$
- in conjunction with the adjustable drive shaft datum, it is therefore possible to adjust the initial and final position of the total angle required

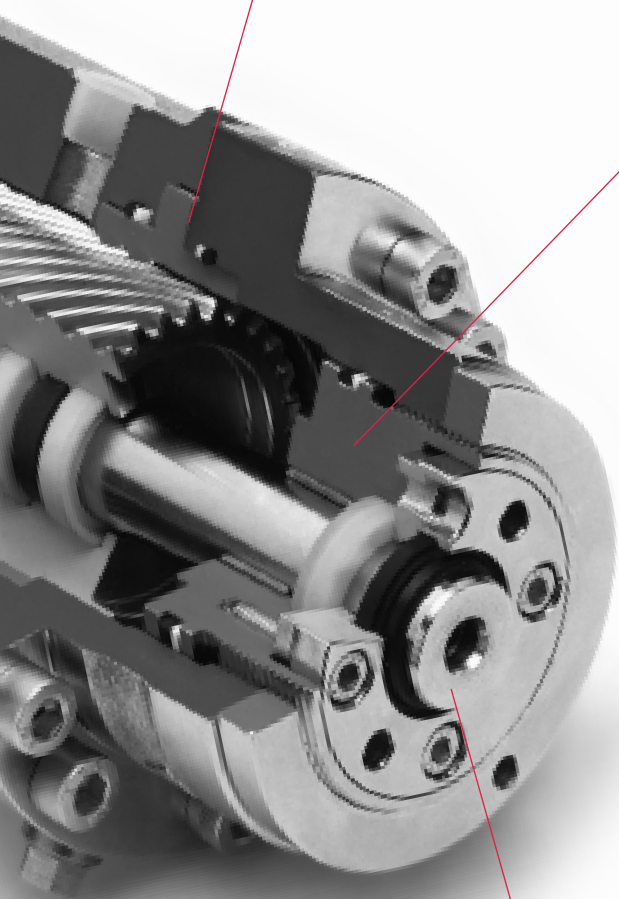

## through shaft

- the axial force required for mounting the shaft on the hub can be exerted at the end of the shaft, preventing destruction of the four-point bearing

## Contents

Features SM4	2, 3
Modular down to the tiniest details	4, 5
Function and features	6, 7
Options	8, 9, 10
End cushioning	10
Technical data and information	11
Dimensions	12, 13
Important technical information	14
Fax sheet	15
Applications	16

# SM4

**[ Extras which give flexibility ]**

Successful companies gain competitive advantage, both for themselves and their customers, through innovative ideas and technologies. On the basis of SM4, we have achieved special designs which are tailored precisely to your needs.

Please feel free to call us - our engineers and technicians will be pleased to help you.

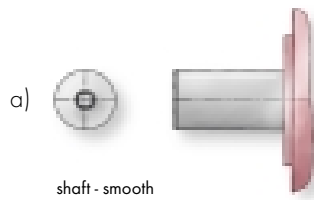
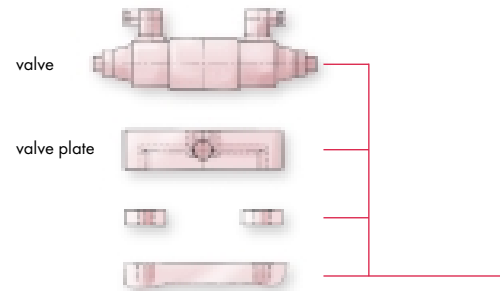

shaft - smooth

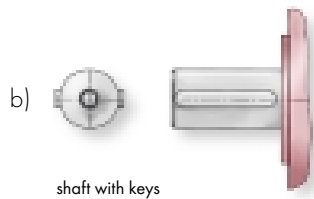

shaft with keys

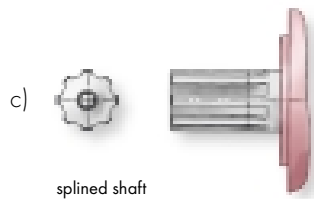

splined shaft

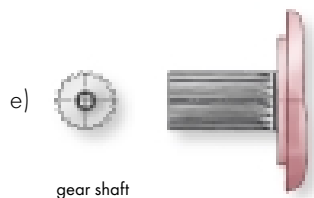

gear shaft

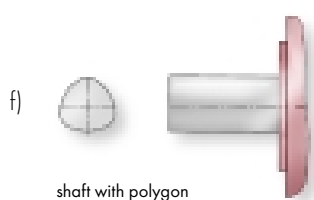

shaft with polygon (also conical)

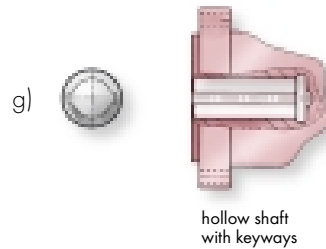

hollow shaft with keyways

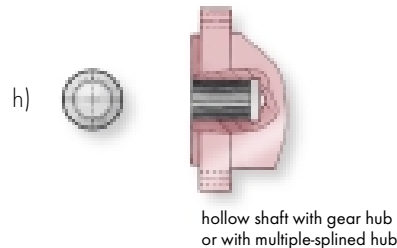

hollow shaft with gear hub or with multiple-splined hub

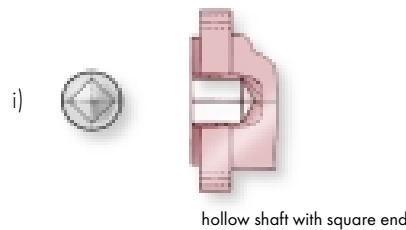

hollow shaft with square end

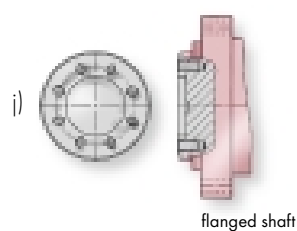

flanged shaft

basic model

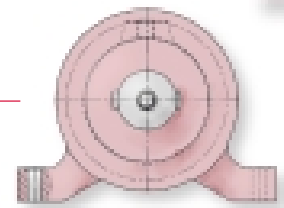
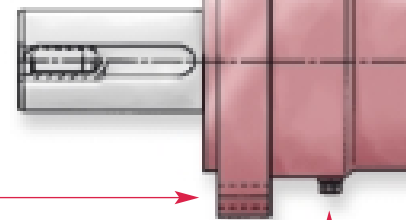

with foot

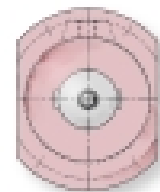

flange - flattened

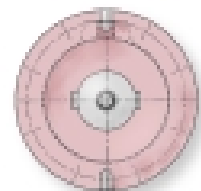

flange with fixing grooves

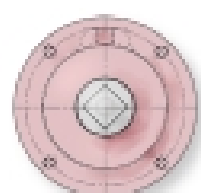

flange according to DIN ISO 5211

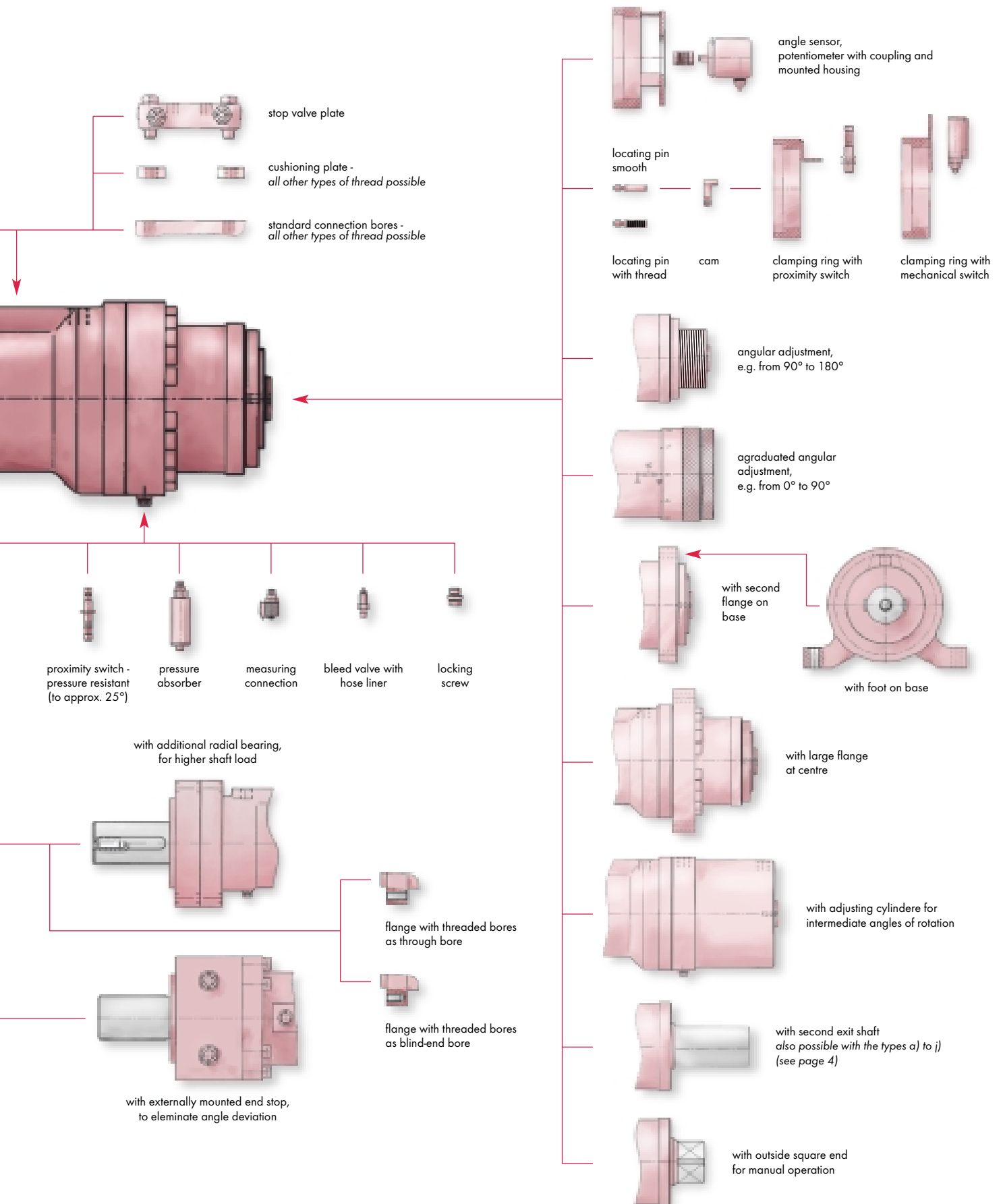

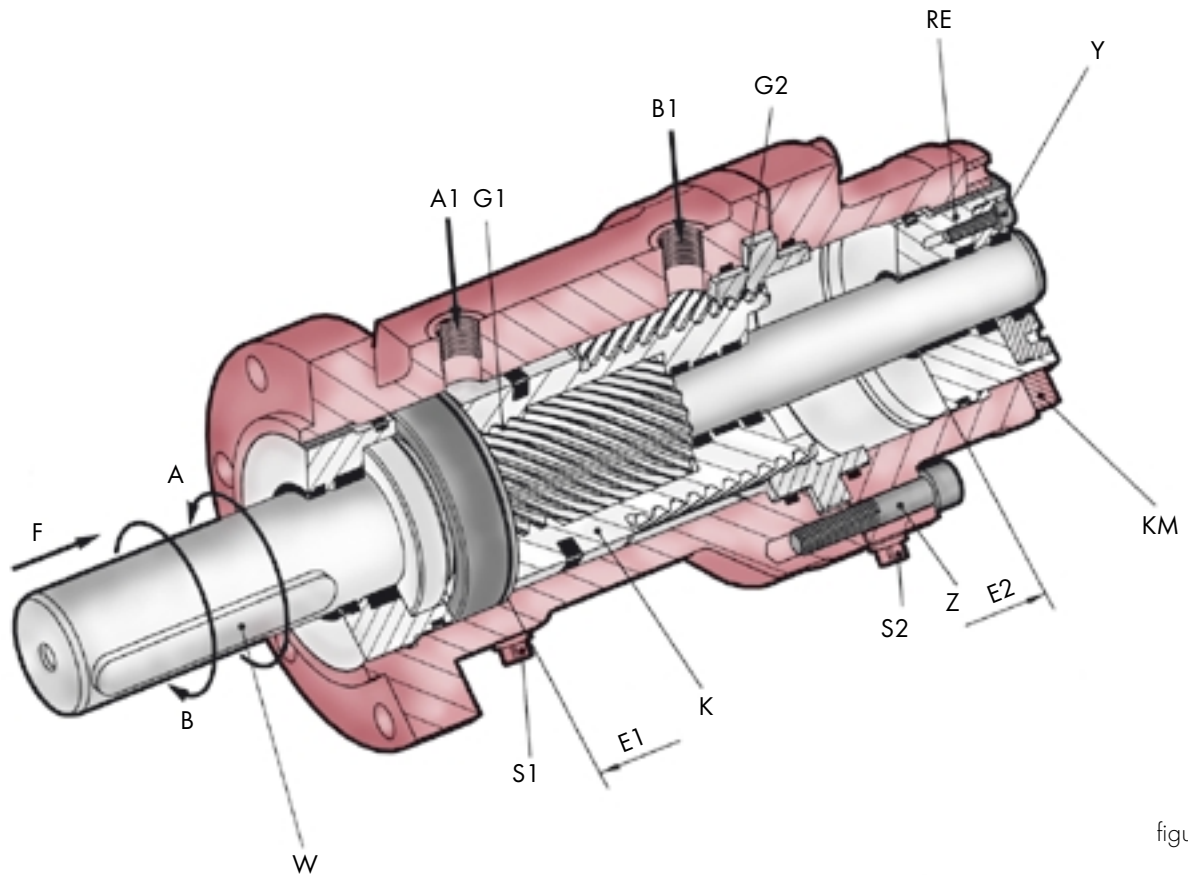

figure-2

### [ Operation ]

The rotary actuator SM4 is used for rotating or turning useful loads.

As in a hydraulic cylinder the piston K (fig.-2) is moved in a linear motion between the two mechanical end positions E1 and E2 by means of hydraulic power.

Through the multiple helical gears the linear motion is mechanically transformed into a turning motion and transferred to the drive shaft W.

The opposed direction of the helical gears G1 and G2 causes a simple stroke of the piston to produce a doubling of the angular movement.

The pairs of helical gears are not self-inhibiting. Positive lubrication and nitriding of the surfaces of the helical gears ensures a long service life of the rotary actuator.

### [ Operating pressure ]

The maximum operating pressure of the rotary actuator is 250 bar. Low friction seals allow the rotary actuator to operate from as low as 10 bar operating pressure and so can be economically set at approximately 20 bar.

For especially slow rotation stick-slip seals can be supplied as a special specification.

### [ Drive shaft datum ]

The drive shaft datum can be adjusted within the angular minute range. After loosening the screws Z (1/2 turn), any drive shaft or key position can be adjusted. Once the required adjustment has been made, tighten the screws Z again as instructed (see manual).

The drive shaft datum is adjusted at the factory as shown in fig.- 2, with the piston K resting against the stop E1 (also see pages 12 and 13).

### [ Torque output ]

The stated torque figures are effective torques, with the pressure versus the torque curve being virtually linear. For multi-shift, heavy duty or high frequency applications a safety factor between 1.2 and 1.5 is recommended. Torque output is equal in both directions.

**[ Shaft rotation ]**

From view F, the drive shaft W will rotate anti-clockwise (arrow A) when pressure is applied to port A1. A different direction of rotation is available as a special feature.

**[ Rotation ]**

Standard rotations are 90°, 180°, 270° and 360°. Other rotations can be supplied on request by using the model with the next standard rotation up and limiting the stroke of the piston in accordance. Also available are special models with rotations in excess of 360°.

**[ Backlash ]**

In order to function, the set of helical gears require a certain backlash of approx. 20 angular minutes. On special request, the rotary actuator can also be supplied with a reduced backlash of as little as 5 angular minutes.

**[ Externally adjustable end stop ]**

This standard feature allows re-adjustment of the angle of rotation as supplied within  $\pm 5^\circ$ . Adjustment is only possible in the unpressurised state and at the end position E2 (see page 14).

**[ Fluids ]**

We recommend mineral oil based hydraulic fluids of the group HLP as per DIN 51524 / Part 2 and VDMA recommendation 24318. Fluids without emulsifying agents reduce the service life of the rotary actuator. For heavily flammable fluids, please consult factory. The recommended viscosity range is 16 cSt to 68 cSt at 40° to 60° C.

**[ Operating temperature ]**

The operating temperature can range from -25° C to +70° C, providing suitable fluids with the correct viscosity rating are used. Please contact us for any applications outside these limits.

**[ Oil change ]**

The oil change depends on the size of the system and should be carried out at regular intervals.

**[ Filtration ]**

The hydraulic fluid used in the rotary actuator does not exceed the pollution classification 19/15 in accordance with ISO 4406. Therefore, a filter setting of  $< 25 \mu\text{m}$  should be installed in the pressure line. With hermetically sealed containers a return filter should suffice. With open containers a pressure filter must be installed in the compressed air line. The maintenance intervals described above should be adhered to in line with manufacturer specifications.

**[ Leakage ]**

The use of solid seals reduces leakage to the absolute minimum, therefore allowing the load to be held in any intermediate position.

**[ End of stroke ]**

The piston K (fig. 2) can be moved under load against the end stops E1 and E2 and be loaded in this position.

The end stops are designed to withstand the force created by the maximum allowable operating pressure relating to the maximum permissible torque output.

If higher forces can be expected, we recommend installation of external stops or other methods of control such as end cushioning (see page 10 and 14) or control valves.

**[ Installation, maintenance and running in ]**

An operating instruction for the installation, maintenance and running in are provided with every delivery.

Spare-part-list as well as dismantling and assembly instruction are available by request.

**[ Non-standard options ]**

In addition to the options listed in this catalogue, special features can also be supplied. A few ideas are listed on pages 4 and 5. Please contact our engineers for further information.

**DO YOU  
THOUGHT AT ALL?**  
Please use our  
fax form  
at page 15.

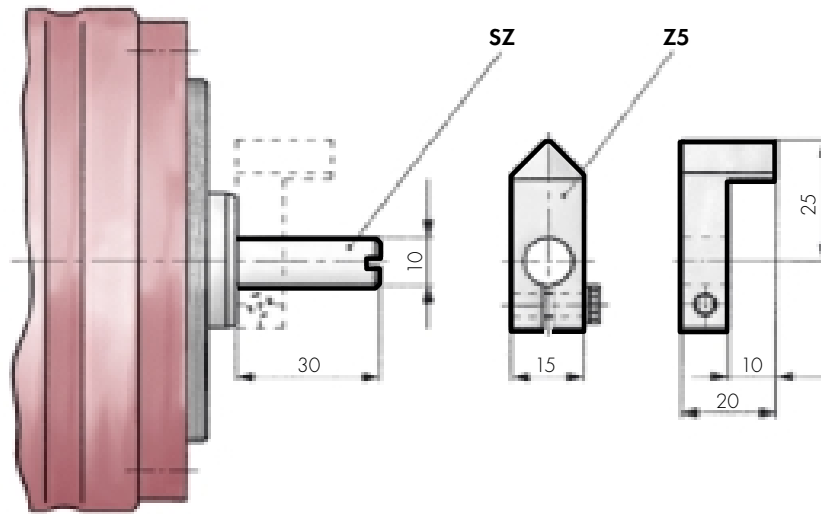

figure-3

#### [ SZ - Locating pin ]

The locating pin SZ (fig. 3) is intended for the fitting of cams Z5 or other control equipment. It simply screws or is glued into the tapping provided at the back end of the shaft. It can be supplied at a later stage without reconstruction of the rotary actuator. The locating pin should not be used for torque transmission or for limiting the angle of rotation.

#### [ Z5 - Cam ]

The cam Z5 (fig. 3) is clamped onto the locating pin SZ and is used to operate the control switches. If two cams are fitted, the second one is reversed and fitted upside down, while both cams remain individually adjustable.

#### [ Z4 - Long-range adjustable end stop ] without illustration

The angle of rotation can be adjusted individually with this option (fig. 4), both over its total range of rotation and over a partial range (e.g. total angle  $270^\circ$ , desired partial adjustment of  $180^\circ$  to  $270^\circ$ ). To this end, the adjusting insert RE is simply screwed inwards or outwards to give the desired angle of rotation. The shaft goes all the way through, allowing control equipment to be fitted. Adjustment is only possible in the unpressurised state. The total length of the rotary actuator is extended by this option, depending on the range of adjustment (see page 12).

#### [ ZW - Gear shaft DIN 5480 ]

The gear shaft profile DIN 5480 is preferable to the standard key connection if high alternating and bending loads are expected. The profile and assembly dimensions are given on page 13.

#### [ ZN - Gear hub DIN 5480 (hollow shaft) ]

Rotary actuators with a gear hub profile as per DIN 5480 shorten the structural length of the total construction, or are used for if the customer's counterpart can not be provided with a hub. The profile and assembly dimensions are given on page 13.

Because of the smaller hub of the rotary actuator caused by construction and the resulting smaller shaft diameter on the customer's counterpart, the maximum torque output of the rotary actuator can no longer be transmitted in view of the "fatigue strength". When planning the application, the pressure should therefore be reduced to 140 bar.

The customer's shaft can however also be subjected to higher loads where operation is sporadic or infrequent. It is always advisable to calculate torsion and fatigue strength.

The maximum permissible operating pressure is still 250 bar. However, care should be taken that the torque produced can not be transmitted to the customer's shaft.



## [ Z6.1 - Control switch assembly ]

This option allows the respective end positions to be mechanically confirmed and the intermediate angles to be recalled. The locating pin SZ and the cam Z5 are included in this option.

### Technical data Z6.1 - mechanical (figure-4):

control element:	according to DIN EN 50047
insulation:	according to VDE 0110 Group C
nominal insulation voltage:	500 V ~ 25-60 Hz
permanent current:	10 A
nominal operating current:	4 A (220~); 2,5 A (380~); 1 A (500~)
permissible temperature:	-30°...+80°
system of protection:	IP 67 according to DIN 40050 p. 1

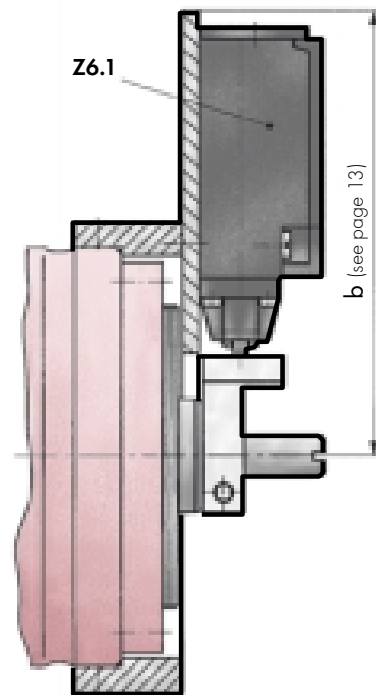

figure-4

## [ Z6.2 - Control switch assembly ]

This option allows the respective end positions to be touchless and electronically confirmed and the intermediate angles to be recalled. The locating pin SZ and the cam Z5 are included in this option. The respective assembly dimensions are given on page 15.

### Technical data Z6.2 - inductive (figure-5):

control element:	PNP Schließer M12x1
nominal control interval:	2 mm
operating voltage:	10 ... 30 V DC
current carrying capacity:	200 mA
connection type:	plug
permissible temperature:	-25°...+70°
system of protection:	IP 67

*Plugs are not delivered as standard!  
Concerning this we ask for your inquiry.*

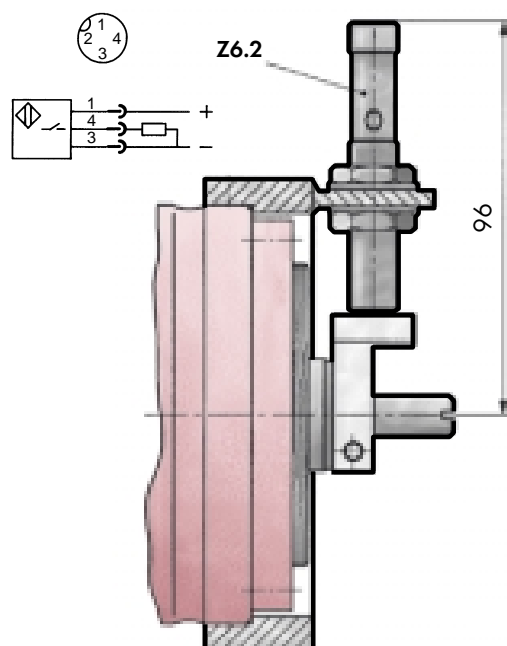

figure-5

### [ Z1- End cushioning ]

End cushioning is aimed at dissipating and/or decelerating the rotary movement before the final end stop.

Eckart end cushioning is designed to meet the toughest requirements in modern hydraulics. On the basis of continuous research and development as well as close co-operation with our customers, we can offer you state-of-the-art end cushioning.

- You do not need to include any expensive proportional or servo controls in order to dissipate kinetic energy, because Eckart end cushioning will perform this function almost identically.
- Eckart end cushioning largely prevents pressure peaks, which often destroy rotary actuators with conventional single-stage cushioning or throttle regulation (see diagram in fig. 9)
- The standard effective cushioning range in the end position is approx. 10° for all sizes. Other cushioning can be supplied on request.

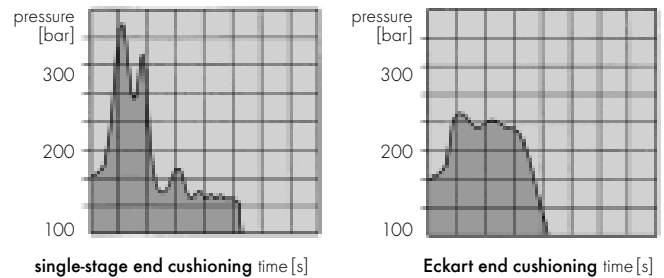

figure-9

The diagram shows one of the advantages of Eckart end cushioning over conventional cushioning with single-stage control

- It is possible for the customer to adjust the cushioning effect individually by screwing in nozzles.
- End cushioning Z1 can also be delivered for each special angle of rotation (see too page 14).

### [ Operation ]

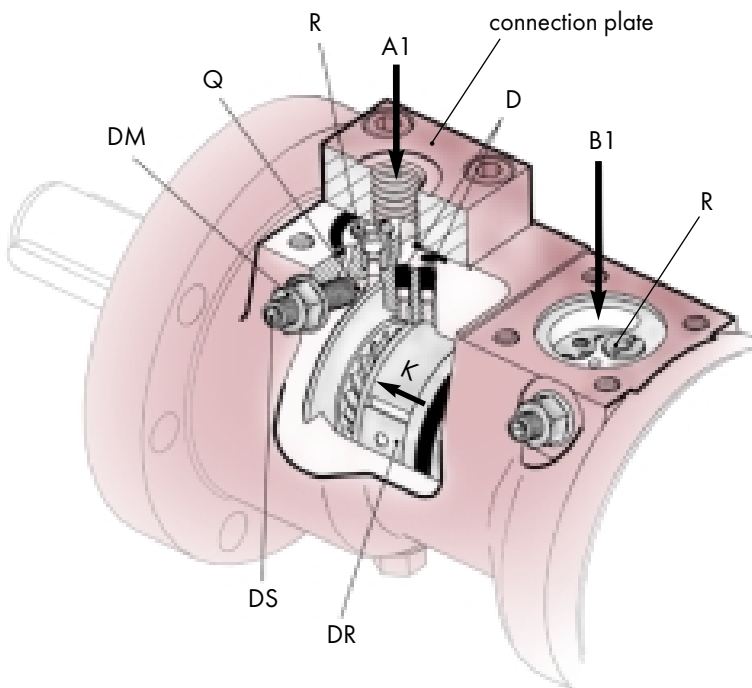

figure-10

#### A. Starting position

- piston K is in end position E2 (see page 6)
- port A1 is pressurised
- port B1 is unpressurised



#### B. Reversing the directional control valve

- port B1 is pressurised
- ball check valve R in port B1 opens
- hydraulic fluid flows freely into the cylinder space
- piston K moves in the direction end position E1 (direction arrow piston K)
- ball check valve R is closed in port A1
- pressure medium flows off freely through the bores D

#### C. Cushioning process

- piston K now approaches the end position E1 and seals the bores D one after the other
- piston speed is progressively reduced
- piston K now completely covers the bores D
- pressure medium can now only escape through the bore Q with the adjusting screw DS to the port A1
- the cushioning effect can therefore be adjusted again by the adjusting screw DS
- the cushioning phase linear

## [ Technical Data ]

Size (piston-Ø)	40	50	63	80	100	125	140	160	180	200	225	250	300		
max. torque at 250 bar [Nm]	180	375	735	1300	2700	5400	8400	12800	19600	26000	34300	48000	85000		
spec. torque [Nm/bar]	0,72	1,50	2,94	5,2	10,8	21,6	33,6	51,2	78,4	104,2	137,2	192,0	340,0		
angle of rotation	standard 90°/180°/270°/360° and any intermediate angle, even above 360°														
medium	recommended: mineral oil of group HLP/DIN 51524, page 2 and VDMA page 24318; others on request														
min. operating pressure required	5 to 10 bar														
max. allowable operating pressure	250 bar / higher on request														
installation position	as required, provided that adequate air bleeding is provided														
temperature range	-25°C to +70°C / higher or lower on request														
absorption volume [cm³/1°]	0,170	0,352	0,669	1,323	2,624	5,154	7,819	11,846	16,559	24,014	32,162	44,767	79,028		
max. admissible rotation time per 90° [s]	0,13	0,18	0,24	0,26	0,43	0,55	0,63	0,73	1,00	1,24	1,50	1,78	2,10		
weight [kg] ca.	angle	90°	5,5	8	11,5	20,5	36	64	92	129	188	246	342	580	984
		180°	5,8	9	13	23	41	75	105	154	220	290	394	687	1100
		270°	6,2	10	16	27	47	84	119	180	253	324	on request		
		360°	6,5	10,5	18	31	52	95	133	205	285	376			
max. radial load F <sub>R</sub>  [kN]	1,45	3,10	4,80	9,80	17,00	25,60	32,00	41,60	53,00	62,30	65,10	68,50	87,20		
max. axial load F <sub>AE</sub>  [kN]	6,02	12,64	14,55	24,35	39,27	61,35	91,50	125,65	155,25	186,50	189,40	198,10	256,25		
max. axial load F <sub>AA</sub>  [kN]	1,00	2,10	3,80	4,95	5,70	6,90	9,00	17,00	22,00	27,00	29,00	32,00	41,00		

## [ Important technical information ]

- Adherence to the data provided here is a precondition for trouble-free operation.
- The regulations of the Technical Supervision, Social Insurance Against Occupational Hazards and the respective environmental regulations etc. must be observed.
- Plant driven by a rotary actuator must be laid out in such a manner that in case of technical or human failure there is no danger of injury or death.
- We reserve the right to alter or improve design specifications without prior notice.

## [ Ordering code ]

**SM4 . 80 – 270° / SZ / Z1 / ... / SO**

250 bar series

size (piston Ø)

rotation (standard)

- other rotations available on request

90°  
180°  
270°  
360°

non-standard options  
(consult factory) omit for standard

options  
- omit for standard

Z1 - end cushioning	SZ - locating pin
Z4 - long-range adjustable end stop	ZW - gear shaft DIN 5480
Z5 - cam	ZN - gear hub DIN 5480
Z6_ - control switch (1-mech./2-ind.)	



[ Standard model - size 225 - 300 ]

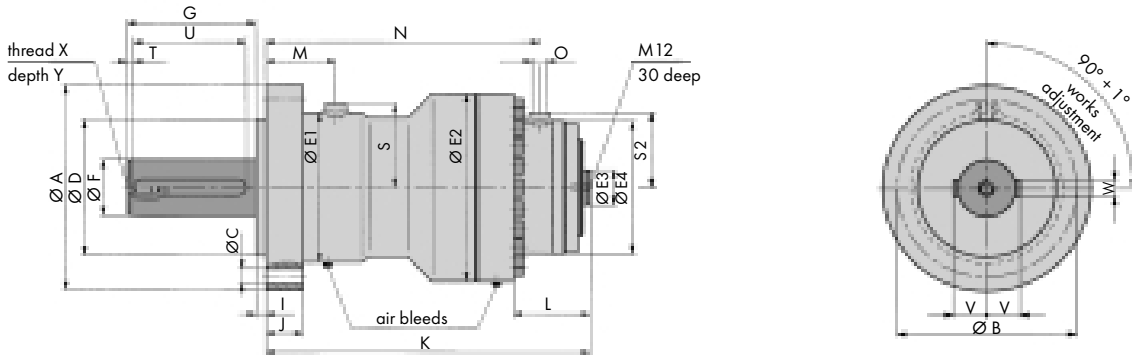

[ Model with gear shaft profile DIN 5480 - ZW ]

[ Model with gear hub profile DIN 5480 - ZN ]

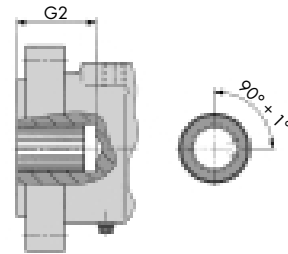
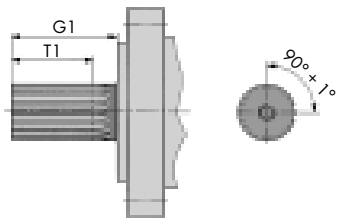

[ Arrangement of flange bores ] ↓ = ports

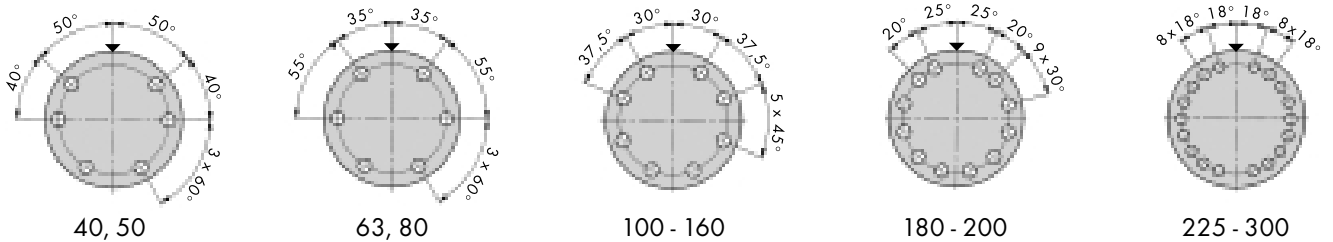

Rotary actuator SM4																ZW	ZN	Z6	Size (piston-Ø)					
N				N1				O	Q	Q1	S	S1 <sup>1)</sup>	S2	T	T1	U DIN 6885	V DIN 6885	W DIN 6885		X	Y	DIN 5480	DIN 5480	b
90°	180°	270°	360°	90°	180°	270°	360°	port size																
89	102,4	115,8	129,2	94,5	107,9	121,3	134,7	G1/4"	40	42	41,5	31,5	55,5	2	33	45	12,5	6	M 6	16	W20x1,25 x14x8F	-	110,8	40
98	116	134	152	102,2	120,2	138,2	156,2	G1/4"	40	42	49	39,5	63	4	43	50	18	8	M 10	22	W30x2 x14x8F	N22x1,25 x12x9H	110,8	50
107	129	151	173	114,2	136,2	158,2	180,2	G3/8"	40	42	53	47	68	4	60	70	20,5	10	M 10	25	W35x2 x16x8F	N28x2 x12x9H	110,8	63
128	155	182	209	134,7	161,7	188,7	215,7	G3/8"	40	42	66	58	81	4	85	100	26	14	M 12	30	W45x2 x21x8F	N35x2 x16x9H	110,8	80
147	182,8	218,6	254,4	151,7	187,5	223,3	259,1	G3/8"	40	42	80	73	95	4	85	100	34	18	M 16	38	W60x3 x18x8F	N48x3 x14x9H	110,8	100
168	213	258	303	173,8	218,8	263,8	308,8	G1/2"	50	52	102	93	122	4	115	125	42	20	M 20	40	W75x3 x24x8F	N60x3 x18x9H	110,8	125
176,5	228,9	281,3	333,7	168,3	220,7	273,1	325,5	G1/2"	50	52	116	115,1	135	4	145	160	47,5	22	M 20	40	W85x3 x27x8F	N70x3 x22x9H	110,8	140
204,5	266,2	327,9	389,6	213,5	275,2	336,9	398,6	G3/4"	50	52	136	127	155	6	180	180	56	28	M 24	50	W100x3 x32x8F	N80x3 x25x9H	110,8	160
229	298	367	436	228,3	297,3	366,3	435,3	G3/4"	50	52	147	138	166	6	180	180	61	28	M 24	50	W110x3 x35x8F	N90x3 x30x9H	140,3	180
242	320,4	398,8	477,2	239,2	317,6	396	474,4	G3/4"	50	52	163	154	182	6	180	180	67	32	M 24	50	W120x5 x22x8F	N95x3 x30x9H	140,3	200
263,1	343,8	424,5	505,2	-	-	-	-	G3/4"	-	-	165	-	187,5	10	160	230	72	32	M 24	50	W130x5 x24x8F	N100x3 x32x9H	154	225
525,5	619,8	714,1	808,4	-	-	-	-	G1"	-	-	190	-	185	10	160	280	83	36	M 24	50	W150x5 x28x8F	N100x3 x35x9H	177	250
606,8	720	833,2	946,4	-	-	-	-	G1"	-	-	233	-	220,5	10	180	280	100	45	M 24	50	W180x5 x34x8F	N130x5 x24x9H	212,5	300

Because of its torque, angle of rotation, pressure range, positioning accuracy, stability of position, type of attachment and dimensions, the Eckart SM4 rotary actuator can be used in a wide range of applications.

The selection and the size depends above all on the demands and the operating conditions under which the rotary actuator is operating. For the planning of special items, it is also important for us to be aware of all technical details.

**[ When planning the rotary actuator, we recommend the following ]**

- The mechanical stops within the rotary actuator are designed to withstand the force created by the maximum allowable operating pressure relating to the maximum permissible torque output. If they are used to stop the load, the forces acting on them, including forces of inertia, must not exceed the force created by the maximum operating pressure.

If higher forces can be expected, we recommend installation of external stops or other methods of control such as end cushioning, as described below, or control valves.

- On hermetic locking of the rotary actuator (e.g. hydraulically controlled double release valves) and the impact of resetting force on the axle a holding pressure is generated. If the holding pressure reaches the level of the operating pressure there is a torque increase on the axle of 38 %. If resetting forces are expected this should be reflected in selecting the size of the rotary actuator. This also has to be taken into consideration in those cases of operation in which the optional end cushioning Z1 is used.
- In order to guarantee a fresh supply of pressure fluid or medium, the pressure connection lines should be kept as short as possible, and/or the directional control valve should be mounted directly onto the rotary actuator. If this is not possible, we recommend a hydraulically controlled double release valve with additional tank line.
- On hermetic locking of the rotary actuator (e.g. hydraulically controlled blocking valves) and the impact of heat from external sources it should be considered that the hydraulic pressure in the rotary actuator increases by about 6-8 bar per 1°C increase of the temperature. In case of substantial temperature increase the rotary actuator could be destroyed. If operating conditions with substantial temperature increases are expected, appropriate protective measures (e.g. safety valves, cycles of operation) should be provided.

In order to provide this we have prepared a catalogue of questions on page 15 which you can fax us if any lack of clarity emerge. Our staff will be glad to work out and submit a proposal to you.

We accept no guarantee claims for disturbances in functioning or complaints which are attributable to lack of information by the customer.

- During installation, care should be taken that the drive shaft or hub is perfectly aligned with the counterpart, since otherwise the maximum permissible radial and axial forces can easily be exceeded.
- In the case of option ZN - gear hub profile DIN 5480, we recommend a calculation of the torsion and fatigue strength of the shaft. Also see page 8.
- In case of changing the angle of rotation on actuators with the end cushioning option Z1, the cushioning effect on the bottom side should also be changed.
- Ensure that air bleeding S1/S2 is accessible (important in the case of end cushioning Z1).
- The rotary actuator needs to be dismantled when changing replacement parts. It is therefore necessary to allow enough clearance for this to be carried out easily.
- In case of rotary actuators with the end cushioning option Z1, the flowing back of the pressure medium is progressively throttled down which causes the hydraulic pressure to rise on the cushioned side of the piston. In this context it must be ensured that the anticipated cushioning pressure does not exceed the operating pressure maximally admissible. As not all factors can be exactly pre-determined, not all requirement profiles can be implemented in configurations which use the end cushioning Z1. For this reason the details of the execution for the end cushioning Z1 must be established under all circumstances during the commissioning of the initial delivery of rotary actuators (we will be glad to assist you concerning this).

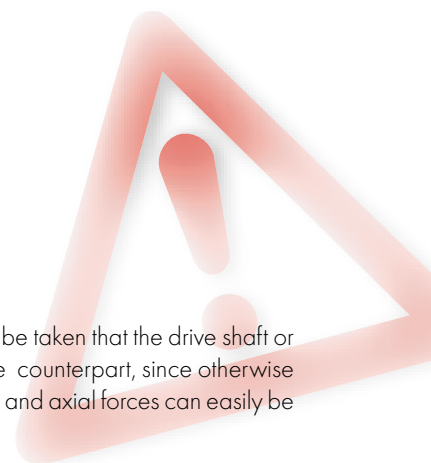



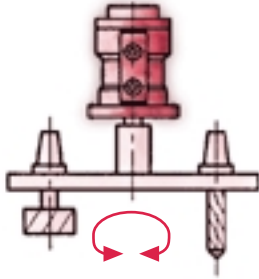

tool change

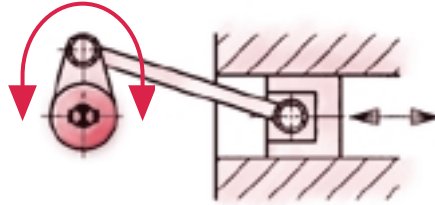

linear actuation

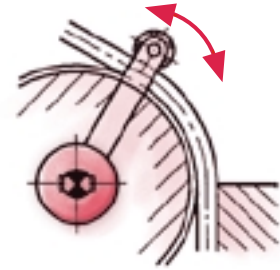

bending machines

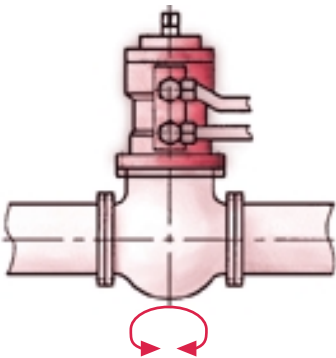

gate valve control

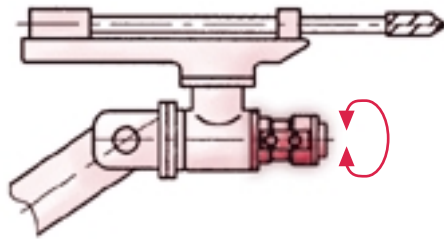

boom rotation

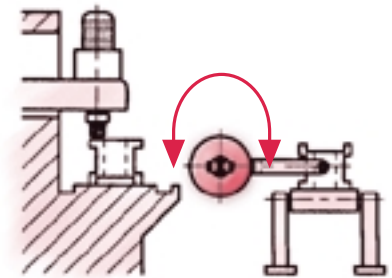

work piece positioning / changing

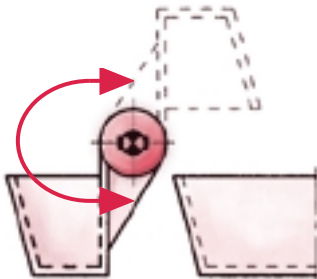

tipping devices

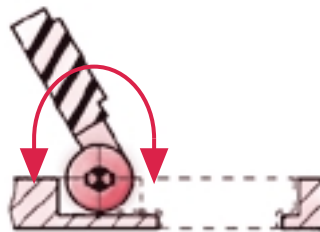

opening / closing

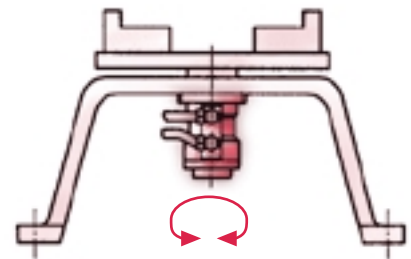

rotational devices

distributed by:

© ECKART GmbH 2002

**ECKART GmbH**Gewerbegebiet Wallroth  
D-36381 Schlüchtern

Telefon +49 (0)6661 9628-0

Telefax +49 (0)6661 9628-50

E-Mail [info@eckart-gmbh.de](mailto:info@eckart-gmbh.de)[http:// www.eckart-gmbh.de](http://www.eckart-gmbh.de)