

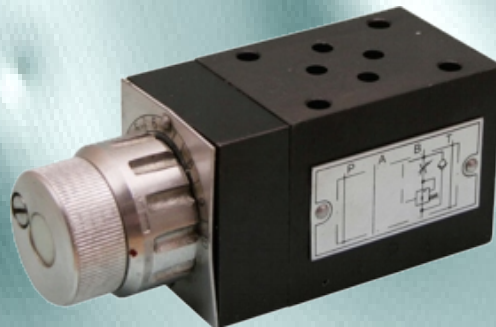

Caproni

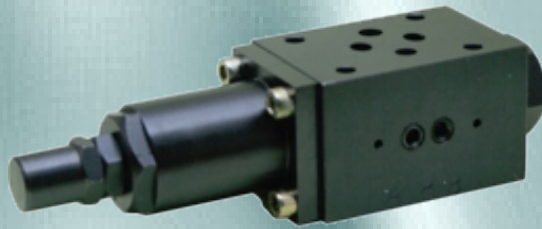
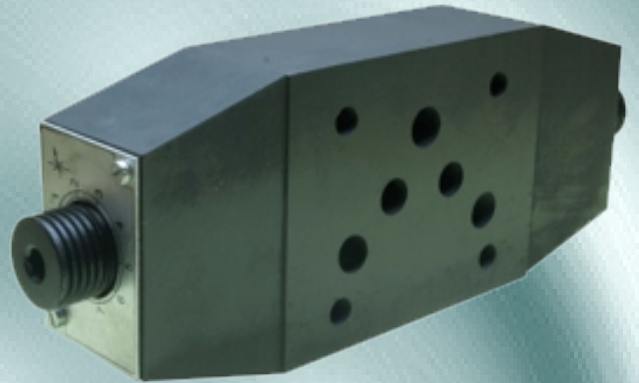
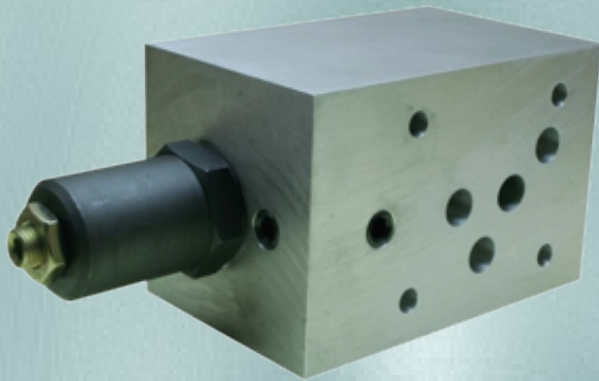

MODULAR VALVES

CONTENTS:	Page
Relief valves:	
KP6M/...	1/19&2/19
KP10M/...	3/19&4/19
Pressure reducing valves:	
KRT6M/...	5/19&6/19
KR10M/...P	7/19
Check valves:	
KO6M/32-...	8/19
KO10M/32-...	9/19
Pilot operated check valves:	
KOHU6M/32-...	10/19
KOHU10M/32-...	11/19
“Overcenter” valves with internal pilot operation:	
OWC6M/25...	12/19
OWC10M/25...	13/19
Throttles check valves:	
DROK6M/32...	14/19
DROK10M/32...	15/19
Adjustable throttles:	
DR6M/32...	16/19
DR10M/32...	17/19
Flow control valves:	
RD6/2M...	18/19&19/19

DESCRIPTION

- ✓ Pressure relief valve with pilot operation.
- ✓ Adjustment of the pressure range at line A to T: KP6M/10A , KP6M/20A , KP6M/32A.
- ✓ Adjustment of the pressure range at line B to T: KP6M/10B , KP6M/20B , KP6M/32B.
- ✓ Adjustment of the pressure range at line P to T: KP6M/10P , KP6M/20P , KP6M/32P.
- ✓ Adjustment of the pressure range at line A&B to T: KP6M/10AB , KP6M/20AB , KP6M/32AB.
- ✓ Adjustment of the pressure range at line A to B&B to A: KP6M/10A , KP6M/20A , KP6M/32A.
- ✓ The pressure relief valve protects the hydraulic drives of overloading or damaging by limiting or maintaining a constant pressure. There is a possibility for the pressure range adjustment at a definite range.
- ✓ Mounting surface CETOP3 (NG6)

DIMENSIONS

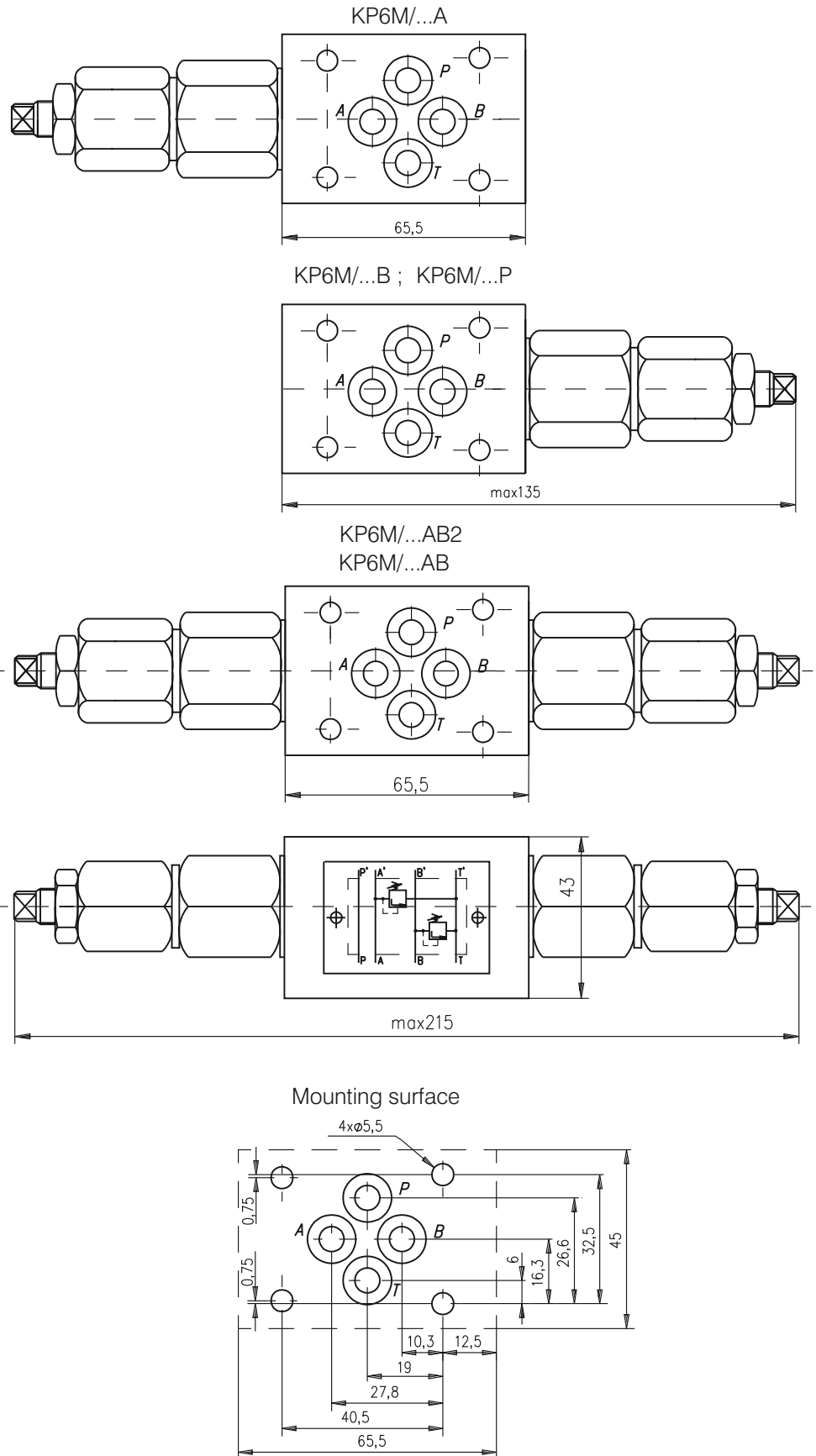

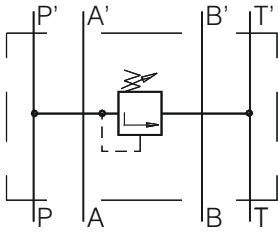
SYMBOL
ORDERING CODE

KP6M/...P

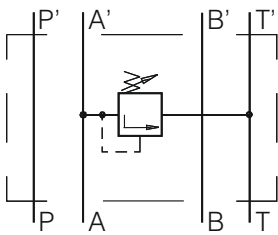

KP6M/...A

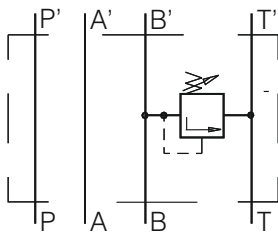

KP6M/...B

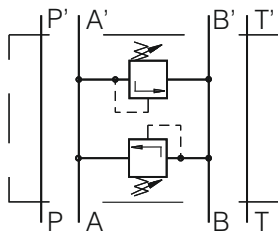

KP6M/...AB2

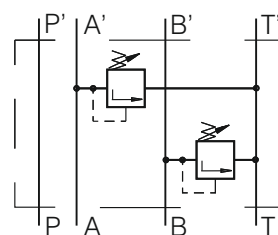

KP6M/...AB

KP	6	M	/	***	-	***
----	---	---	---	-----	---	-----

Relief valve

Nominal bore 6mm.

Modular mounting

 Rated pressure:

up to 100 bar.-10
up to 200 bar.-20
up to 320 bar.-32

 Function:

at line A to T - A
at line B to T - B
at line P to T - P
at line A and B to T - AB
at line A to B & at B to A - AB2

TECHNICAL DATA

Weight	with one relief valve	1,150kg
	with two relief valves	1,400 kg

Rated flow ($\Delta p=2,5$ bar.)	20 l/min
-----------------------------------	----------

Adjustment of pressure range:	
KP6M/10P , KP6M/10A , KP6M/10B , KP6M/10AB , KP6M10AB2	5...100 bar

KP6M/20P , KP6M/20A , KP6M/20B , KP6M/20AB , KP6M20AB2	15...200 bar
---	--------------

KP6M/32P , KP6M/32A , KP6M/32B , KP6M/32AB , KP6M32AB2	20...320 bar
---	--------------

Working liquid-hydraulic oils with characteristics:	
-viscosity	10...400 cSt
-degree of filtration	0,025 mm
-temperature	-20...+80°C

DESCRIPTION

- ✓ Pressure relief valve with pilot operation.
- ✓ Adjustment of the pressure range at line A to T: KP10M/10A , KP10M/20A, KP10M/32A.
- ✓ Adjustment of the pressure range at line B to T: KP10M/10B , KP10M/20B, KP10M/32B.
- ✓ Adjustment of the pressure range at line P to T: KP10M/10P , KP10M/20P, KP10M/32P.
- ✓ Adjustment of the pressure range at line A&B to T: KP10M/10AB , KP10M/20AB , KP10M/32AB.
- ✓ Adjustment of the pressure range at line A to B&B to A: KP10M/10A , KP10M/20A , KP10M/32A.
- ✓ The pressure relief valve protects the hydraulic drives of overloading or damaging by limiting or maintaining a constant pressure. There is a possibility for the pressure range adjustment at a definite range.
- ✓ Mounting surface CETOP5 (NG10)

DIMENSIONS

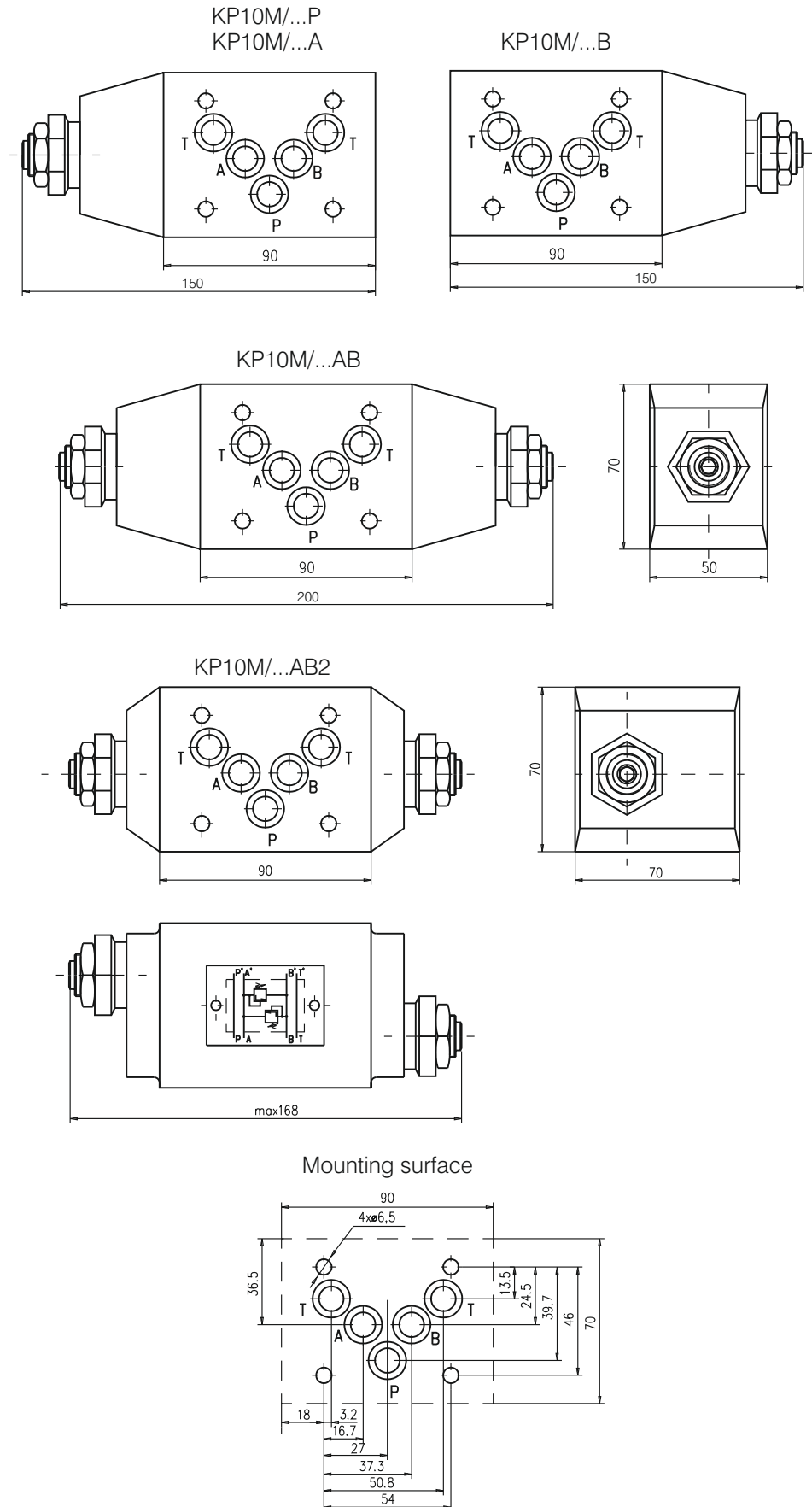

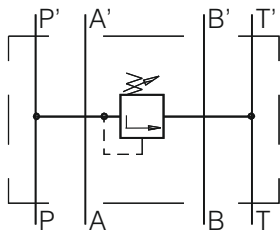
SYMBOL
ORDERING CODE

KP10M/...P

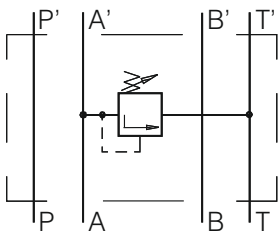

KP10M/...A

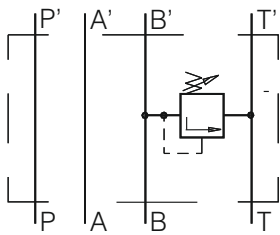

KP10M/...B

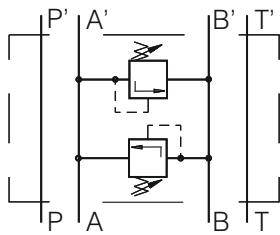

KP10M/...AB2

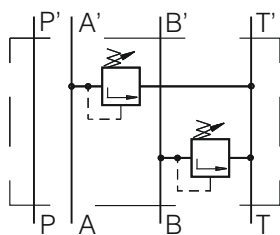

KP10M/...AB

KP	10	M	/	***	-	***
----	----	---	---	-----	---	-----

Relief valve

Nominal bore 10mm.

Modular mounting

 Rated pressure:

up to 100 bar.-10
up to 200 bar.-20
up to 320 bar.-32

 Function:

at line A to T - A
at line B to T - B
at line P to T - P
at line A and B to T - AB
at line A to B & at B to A - AB2

TECHNICAL DATA

Weight	with one relief valve	2,700kg
	with two relief valves	3,050 kg
Rated flow ($\Delta p=2,5$ bar.)		40 l/min
Adjustment of pressure range:		
KP10M/10P , KP10M/10A , KP10M/10B , KP10M/10AB , KP10M10AB2		5...100 bar
KP10M/20P , KP10M/20A , KP10M/20B , KP10M/20AB , KP10M20AB2		15...200 bar
KP10M/32P , KP10M/32A , KP10M/32B , KP10M/32AB , KP10M32AB2		20...320 bar
Working liquid-hydraulic oils with characteristics:		
-viscosity		10...400 cSt
-degree of filtration		0,025 mm
-temperature		-20...+80°C

DESCRIPTION

- ✓ Pressure reducing valves for modular mounting-KRT6M/...
- ✓ The pressure reducing valves are used to limit the pressure in the separate sections of the hydraulic systems where constant pressure is achieved (at element outlet) lower than the inlet pressure and independent of its changing.
- ✓ Mounting surface CETOP3 (NG6)

DIMENSIONS

KRT6M/1,6P ; KRT6M/10P ; KRT6M/21P ; (KRT6M/...A)

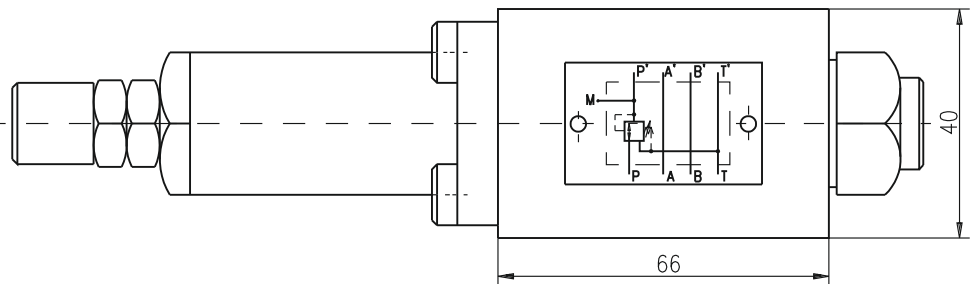
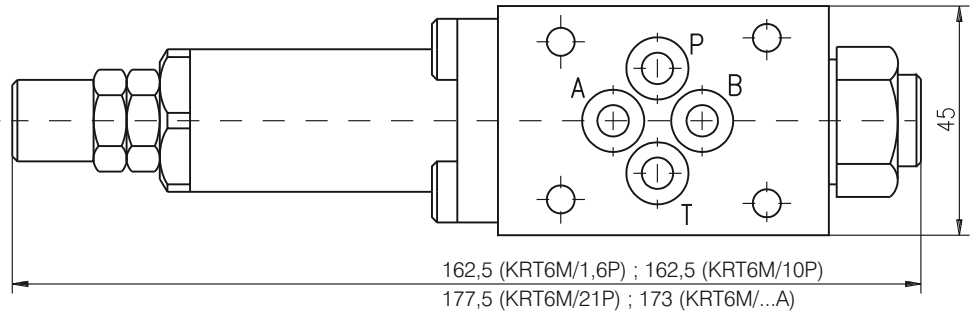

KRT6M/...B

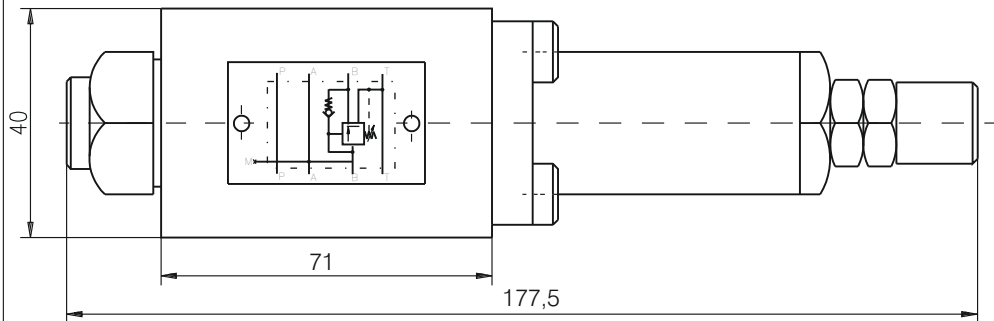

Mounting surface

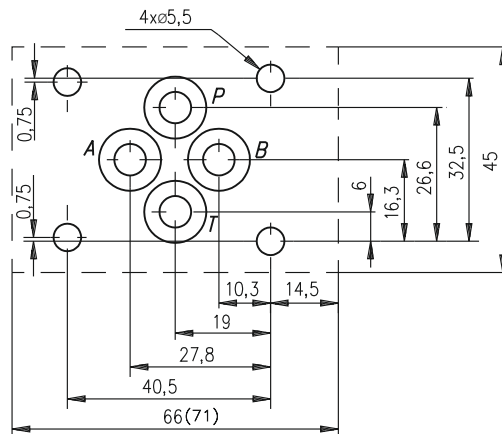

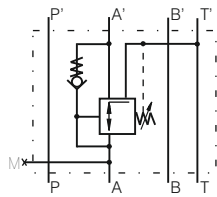
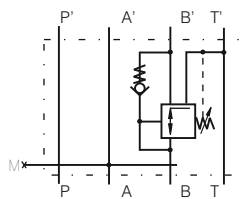
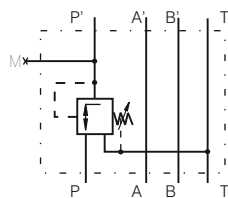
SYMBOL
ORDERING CODE

KRT6M/10A

KRT6M/10B

KRT6M/...P

KRT	6	M	/	***	***
-----	---	---	---	-----	-----

Pressure reducing valve

Nominal bore 6mm.

Modular mounting

 Pressure reducing range:

up to 16 bar.-1,6
up to 100 bar.-10
up to 210 bar.- 21

 Function - Pressure reducing

in line P to P' - P
in line A' to A - A
in line B' to B - B

TECHNICAL DATA

Weight	1,165 kg	
	1,4 kg (KRT6M/21P)	
Max. inlet pressure	320 bar	
Rated flow ($\Delta p=2,5\text{bar}$)	20 l/min	
	Pressure reducing range:	Safety pressure range:
KRT6M/1,6P	0,8...16 bar	3...16 bar
KRT6M/10P	10...100 bar	20...100 bar
KRT6M/21P	20...210 bar	30...210 bar
KRT6M/10A	10...100 bar	20...100 bar
KRT6M/10B	10...100 bar	20...100 bar
Working liquid-hydraulic oils with characteristics:		
	-viscosity	10...400 cSt
	-degree of filtration	0,025 mm
	-temperature	-20...+80°C

DESCRIPTION

- ✓ Pressure reducing valves for modular mounting-KR10M/...P
- ✓ The pressure reducing valves are used to limit the pressure in the separate sections of the hydraulic systems where constant pressure is achieved (at element outlet) lower than the inlet pressure and independent of its changing.
- ✓ Mounting surface CETOP5 (NG10)

DIMENSIONS

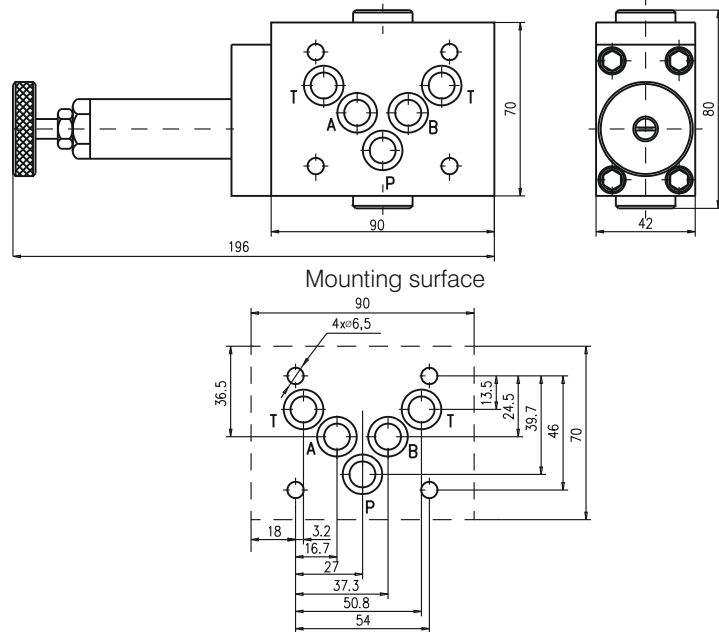

SYMBOL

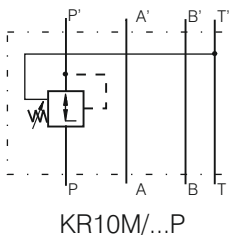

ORDERING CODE

KR 10 M / *** P

Pressure reducing valve

Nominal bore 10mm.

Modular mounting

Pressure reducing range: up to 100 bar.-10
 up to 200 bar.-20
 up to 200 bar.-32

Function - at line P to P'-P

TECHNICAL DATA

Weight	1,165 kg
Max. inlet pressure	320 bar
Rated flow ($\Delta p=2,5$ bar.)	40 l/min
Adjustment of pressure reducing range:	
KR10M/10P	Pr($P > P'$) 3...100 bar
KR10M/20P	Pr($P > P'$) 10...200 bar
KRT10M/32P	Pr($P > P'$) 20...320 bar
Working liquid-hydraulic oils with characteristics:	
-viscosity	10...400 cSt
-degree of filtration	0,025 mm
-temperature	-20...+80°C

DESCRIPTION

- ✓ Check valves for modular mounting-KO6M/32...
- ✓ Check valves give leak free closure in one direction and allow free passing in the other.
- ✓ Mounting surface CETOP3 (NG6)

DIMENSIONS

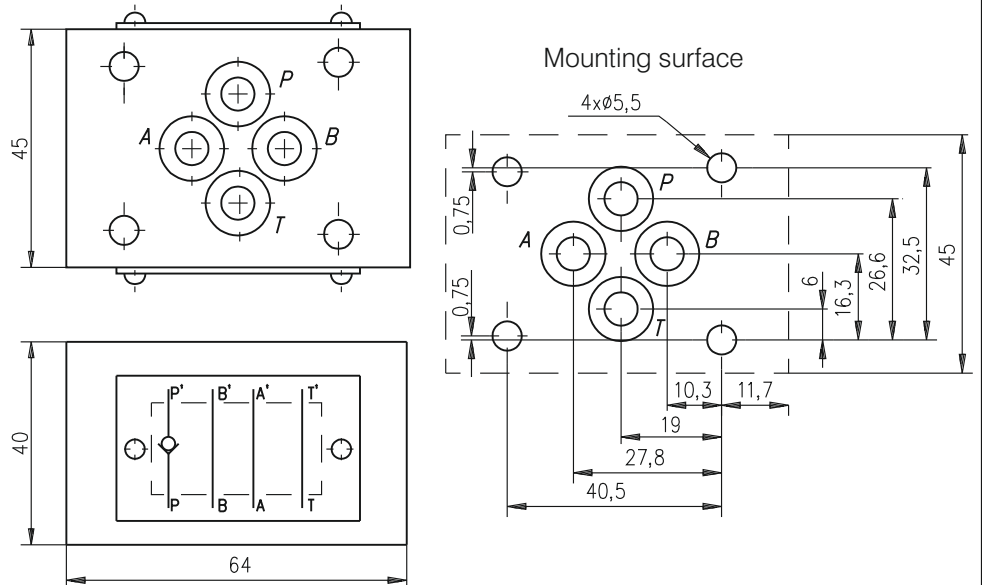

SYMBOL

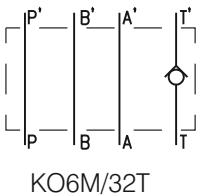
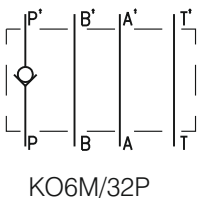
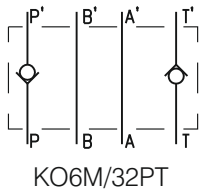

ORDERING CODE

KO 6 M / 32 ***

Check valve

Nominal bore 6mm.

Modular mounting

Rated pressure: up to 320 bar.-32

Function

- at line P to P' - P

- at line T' to T - T

- at line P to P'&T' to T - PT

TECHNICAL DATA

Weight	0,800 kg
Max. Pressure	320 bar
Rated flow ($\Delta p=5$ bar.)	30 l/min
Cracking pressure	0,5 bar
Working liquid-hydraulic oils with characteristics:	
-viscosity	10...400 cSt
-degree of filtration	0,025 mm
-temperature	-20...+80°C

DESCRIPTION

- ✓ Check valves for modular mounting-KO10M/32...
- ✓ Check valves give leak free closure in one direction and allow free passing in the other.
- ✓ Mounting surface CETOP5 (NG10)

DIMENSIONS

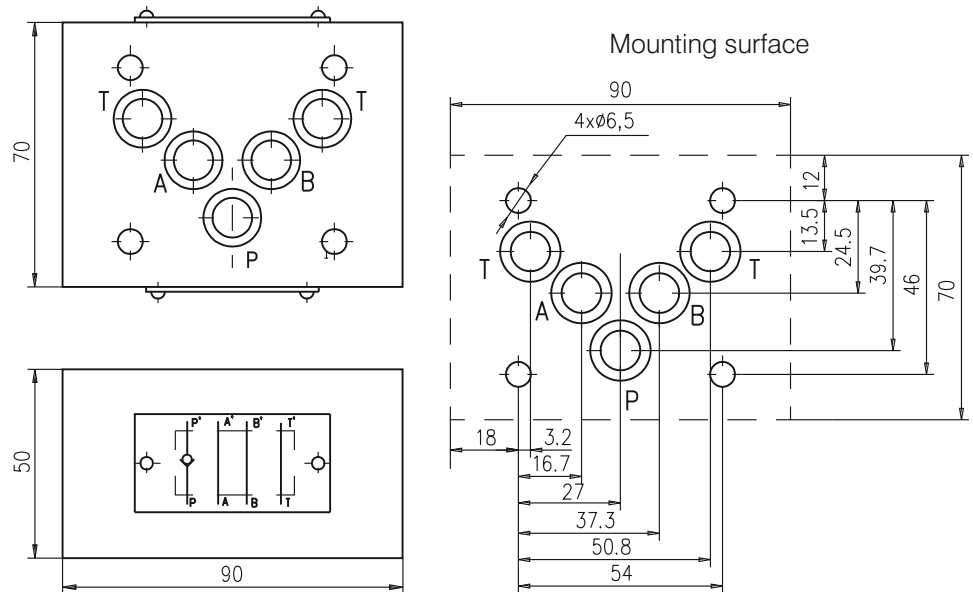

SYMBOL

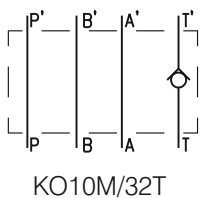
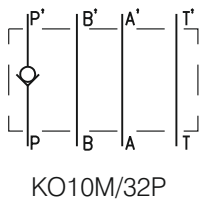
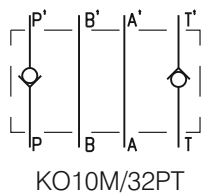

ORDERING CODE

KO 10 M / 32 ***

Check valve

Nominal bore 10mm.

Modular mounting

Rated pressure: up to 320 bar. **-32**

Function

- at line P to P' - **P**
- at line T' to T - **T**
- at line P to P' & T' to T - **PT**

TECHNICAL DATA

Weight	2,300 kg
Max. Pressure	320 bar
Rated flow ($\Delta p=5$ bar.)	40 l/min
Cracking pressure	0,8 bar
Working liquid-hydraulic oils with characteristics:	
-viscosity	10...400 cSt
-degree of filtration	0,025 mm
-temperature	-20...+80°C

DESCRIPTION

✓ Check valves with hydraulic operation for modular mounting-KOHU6M/32-...
 ✓ Hydraulically operated check valve is designed to allow working liquid passing in one direction freely (A' to A , B' to B) and at availability of control signal in the opposite direction (A to A' , B to B'). The valve ensures hydraulic "locking" of the hydraulic cylinders , i.e. Provides their stability under load at neutral position of the directional control valve.
 ✓ Mounting surface CETOP3 (NG6)

DIMENSIONS

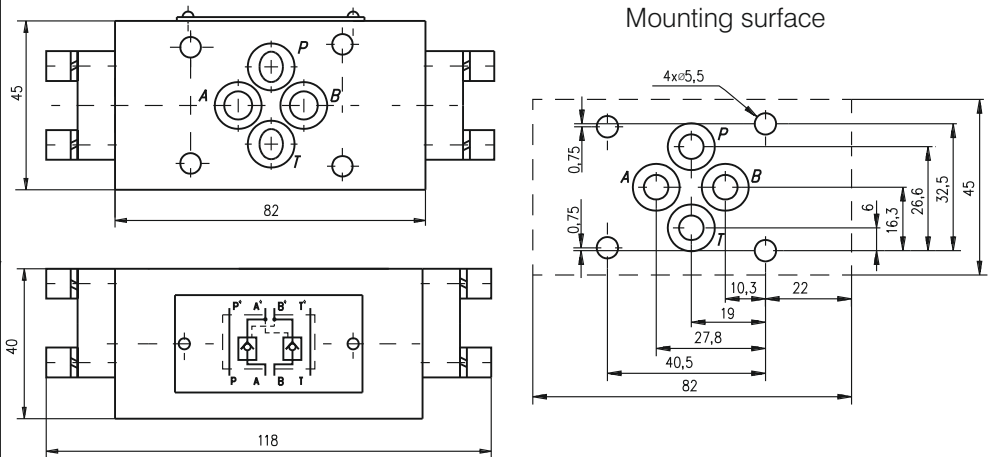

ORDERING CODE

KOHU 6 M / 32 - 2 ***

Check valve with hydraulic operation

Nominal bore 6mm.

Modular mounting

Rated pressure: up to 320 bar.-32

Modification

Valve position: at line A - A
 at line B - B
 at line A and B - C

SYMBOL

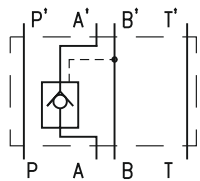

KOHU6M/32-2A

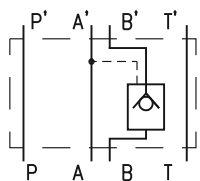

KOHU6M/32-2B

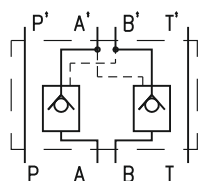

KOHU6M/32-2C

TECHNICAL DATA

Max. Pressure	320 bar
Rated flow ($\Delta p=2,5$ bar.)	20 l/min
Cracking pressure (for check valve)	0,4 bar
Pilot ratio	1/8
Working liquid-hydraulic oils with characteristics:	
-viscosity	10...400 cSt
-degree of filtration	0,025 mm
-temperature	-20...+80°C

DESCRIPTION

✓ Check valves with hydraulic operation for modular mounting-KOHU10M/32-...

✓ Hydraulically operated check valve is designed to allow working liquid passing in one direction freely (A' to A, B' to B) and at availability of control signal in the opposite direction (A to A', B to B'). The valve ensures hydraulic "locking" of the hydraulic cylinders, i.e. Provides their stability under load at neutral position of the directional control valve.

✓ Mounting surface CETOP5 (NG10)

DIMENSIONS

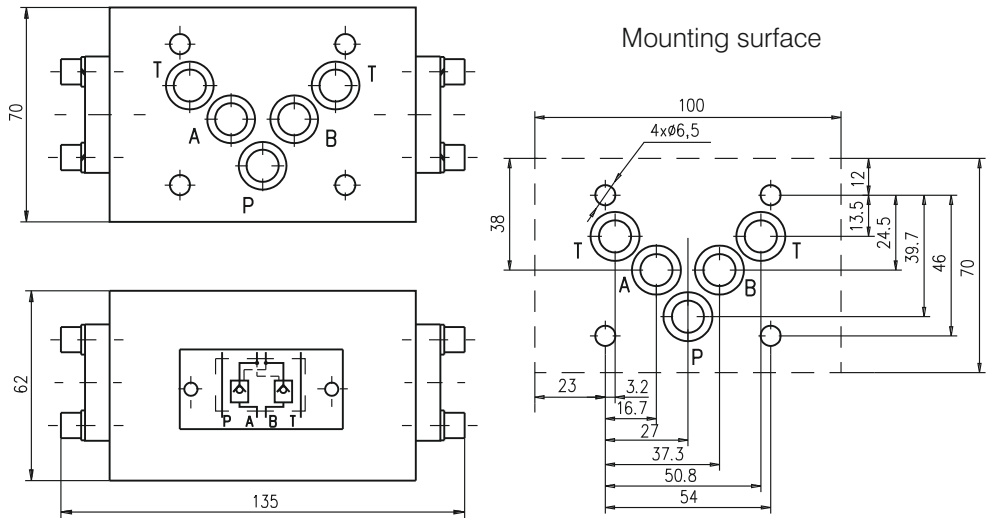

ORDERING CODE

KOHU 10 M / 32 - 2 ***

Check valve with hydraulic operation

Nominal bore 10mm.

Modular mounting

Rated pressure: up to 320 bar.-32

Modification

Valve position:
 at line A - A
 at line B - B
 at line A and B - C

SYMBOL

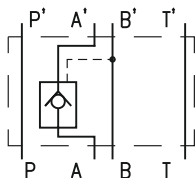

KOHU10M/32-2A

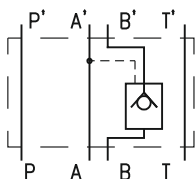

KOHU10M/32-2B

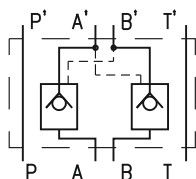

KOHU10M/32-2C

TECHNICAL DATA

Max. Pressure	320 bar
Rated flow ($\Delta p=2,5$ bar.)	40 l/min
Cracking pressure (for check valve)	0,5 bar
Pilot ratio	1/16
Working liquid-hydraulic oils with characteristics:	
-viscosity	10...400 cSt
-degree of filtration	0,025 mm
-temperature	-20...+80°C

DESCRIPTION

- ✓ “OVERCENTER” valves with internal pilot operation for modular mounting-OWC6M/25...
- ✓ The “OVERCENTER” valves are designed to control moving loads and to prevent loads from running ahead of pump. They lock the load in any position without drift and protect of overloading and thermal expansion by open center control valves.
- ✓ Mounting surface CETOP3 (NG6)

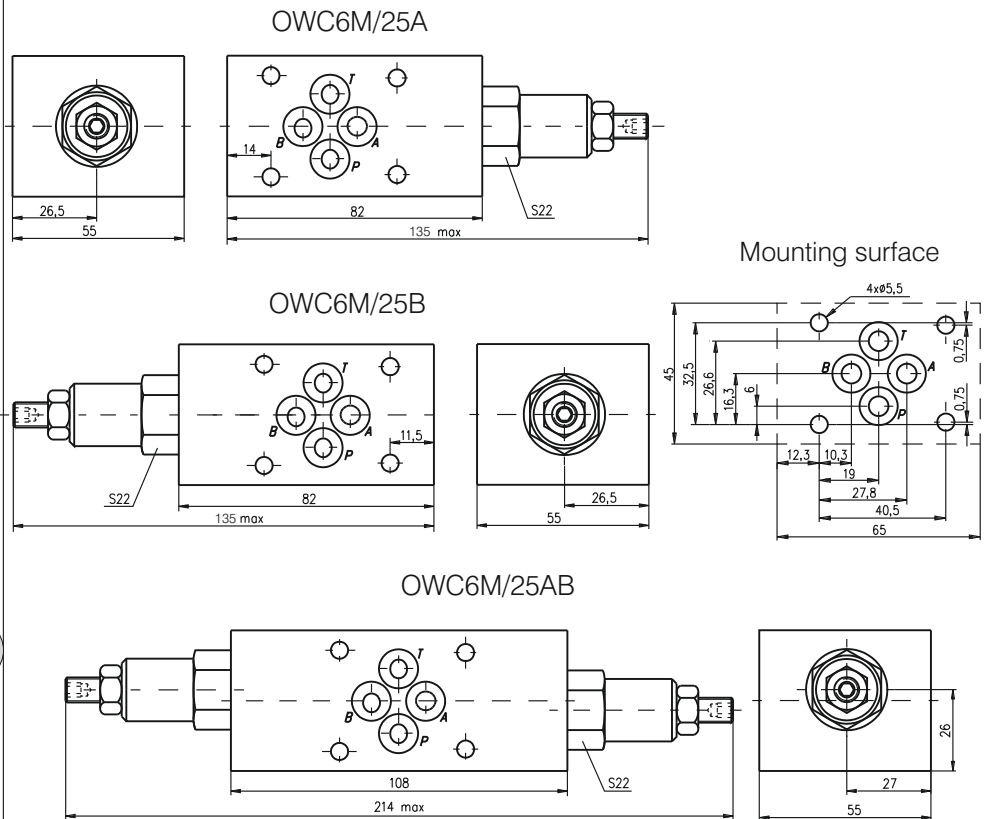
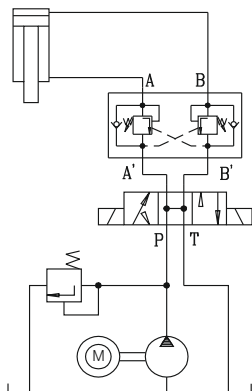
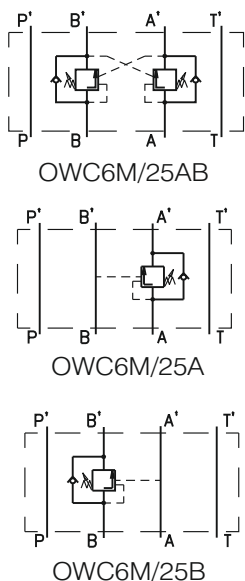
DIMENSIONS

APPLICATIONS

SYMBOL

ORDERING CODE

OWC	6	M	/	25	***
-----	---	---	---	----	-----

OVERCENTER
 Nominal bore 6mm
 Modular mounting
 Rated pressure up to 250 bar.
 Valve position: at line A - A
 at line B - B
 at line A&B - AB

TECHNICAL DATA

Rated pressure	250 bar
Pressure adjustment range	40...250 bar.
Rated flow	for all types 20 l/min
Pilot ratio	4/1
Working liquid-hydraulic oils with characteristics:	
-viscosity	10...400 cSt
-degree of filtration	0,025 mm
-temperature	-20...+80°C

DESCRIPTION

- ✓ “OVERCENTER” valves with internal pilot operation for modular mounting-OWC10M/25...
- ✓ The “OVERCENTER” valves are designed to control moving loads and to prevent loads from running ahead of pump. They lock the load in any position without drift and protect of overloading and thermal expansion by open center control valves.
- ✓ Mounting surface CETOP5 (NG10)

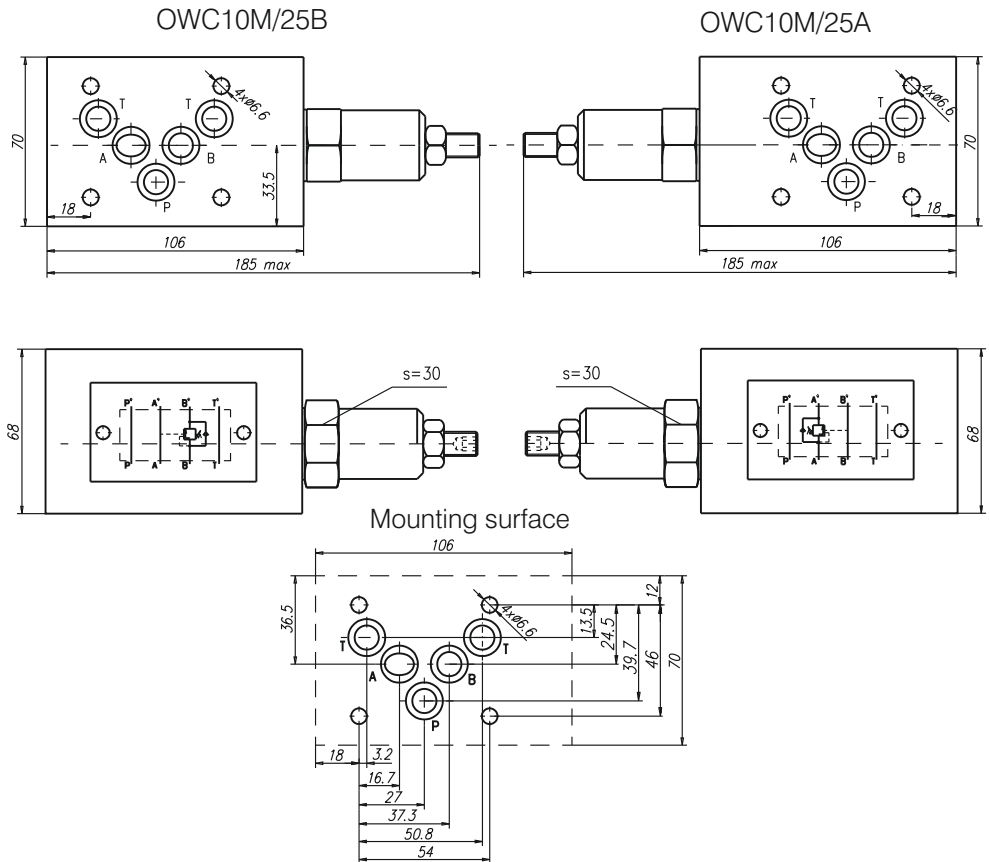
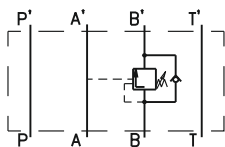
DIMENSIONS

SYMBOL

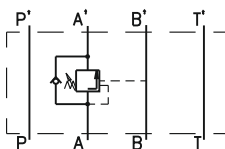
OWC10M/25B



OWC10M/25A

ORDERING CODE

OWC	10	M	/	25	**
-----	----	---	---	----	----

OVERCENTER

Nominal bore 10mm

Modular mounting

Rated pressure

up to 250 bar.

Valve location:

at line A - A

at line B - B

TECHNICAL DATA

Rated pressure	250 bar
Pressure adjustment range	20...250 bar
Rated flow	for all types 80 l/min
Pilot ratio	for all types 4,2/1
Working liquid-hydraulic oils with characteristics:	
-viscosity	10...400 cSt
-degree of filtration	0,025 mm
-temperature	-20...+80°C

DESCRIPTION

- ✓ Adjustable throttles with check valves for modular mounting-DROK6M/32-...
- ✓ The throttle check valves limit the flow by adjustable throttling spool at one direction, and allow free return passing through the other.
- ✓ Mounting surface CETOP3 (NG6)

DIMENSIONS

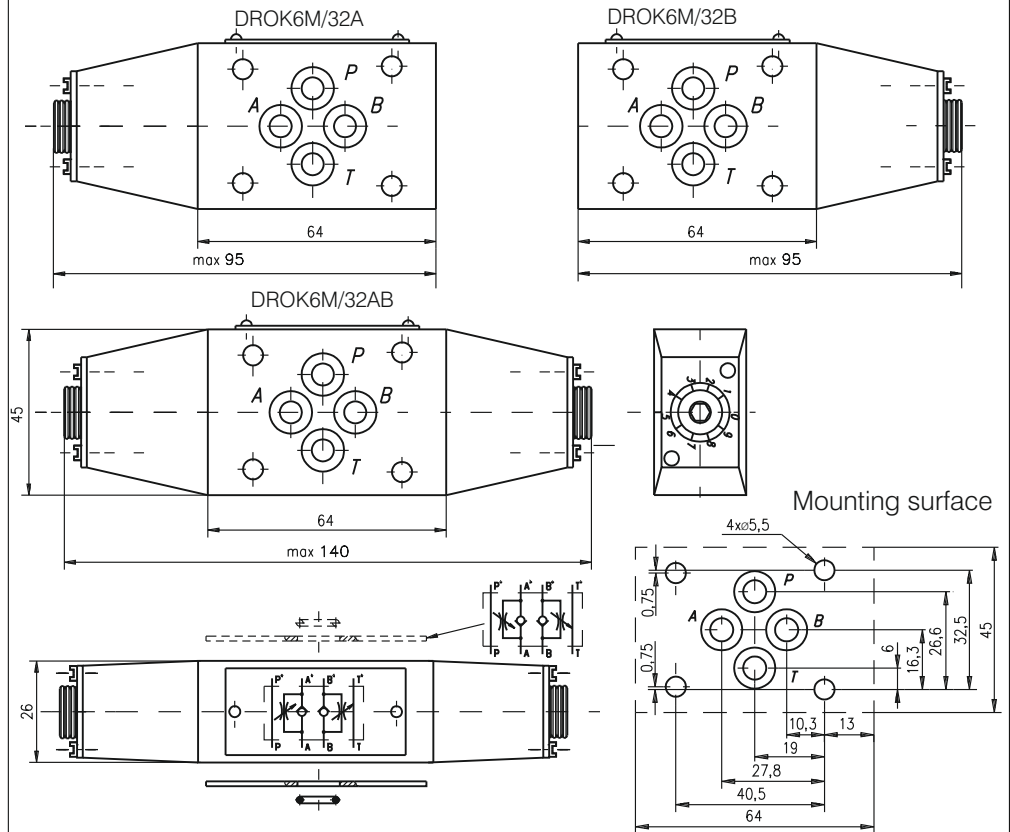

SYMBOL

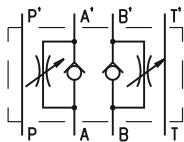

DROK6M/32AB

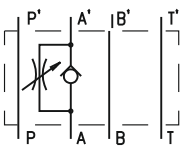

DROK6M/32A

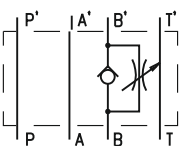

DROK6M/32B

ORDERING CODE

DROK 6 M / 32 ***

Adjustable throttle with check valve

Nominal bore 6mm.

Modular mounting

Rated pressure: up to 320 bar.-32

Valve location:
 at line A - A
 at line B - B
 at line A and B - AB

TECHNICAL DATA

Weight	DROK6M/32A and DROK6M/32A	0,650 kg
	DROK6M32/AB	0,810 kg
Max. Pressure		320 bar
Rated flow ($\Delta p=3,5$ bar.)		20 l/min
Cracking pressure (for check valve)		0,2 bar
Working liquid-hydraulic oils with characteristics:		
-viscosity		10...400 cSt
-degree of filtration		0,025 mm
-temperature		-20...+80°C

DESCRIPTION

- ✓ Adjustable throttles with check valves for modular mounting-DROK10M/32-...
- ✓ The throttle check valves limit the flow by adjustable throttling spool at one direction , and allow free return passing on the other.
- ✓ Mounting surface CETOP5 (NG10)

DIMENSIONS

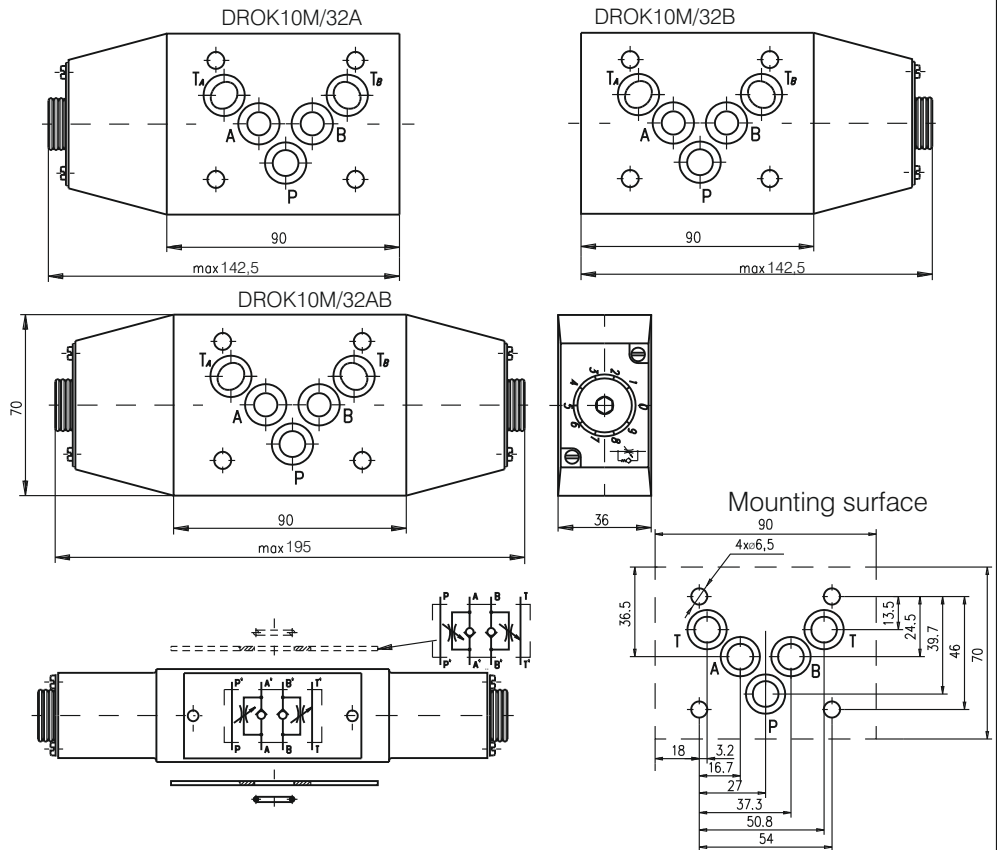

SYMBOL

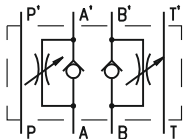

DROK10M/32AB

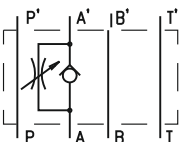

DROK10M/32A

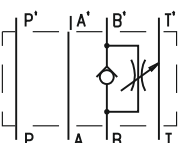

DROK10M/32B

ORDERING CODE

DROK 10 M / 32 ***

Adjustable throttle with check valve

Nominal bore 10mm.

Modular mounting

Rated pressure: up to 320 bar.-32

Valve location: at line A - A
at line B - B
at line A and B - AB

TECHNICAL DATA

Weight	DROK10M/32A and DROK10M/32B	2,100 kg
	DROK10M32/AB	2,500 kg
Max. Pressure		320 bar
Rated flow ($\Delta p=2,5$ bar.)		40 l/min
Cracking pressure (for check valve)		0,2 bar
Working liquid-hydraulic oils with characteristics:		
-viscosity		10...400 cSt
-degree of filtration		0,025 mm
-temperature		-20...+80°C

DESCRIPTION

- ✓ Adjustable throttles for modular mounting-DR6M/32...
- ✓ The valve throttles , or completely stops the flow in any direction , so creating resistance to flow regulation and support in the hydraulic system.
- ✓ Mounting surface CETOP3 (NG6)

DIMENSIONS

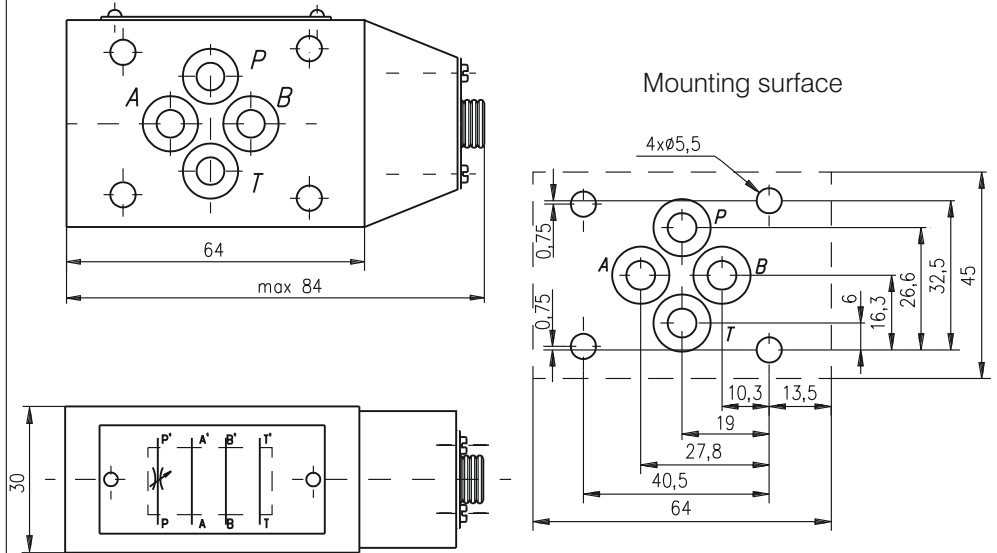

SYMBOL

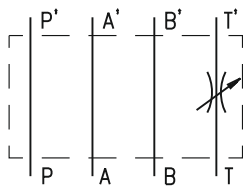

DR6M/32T

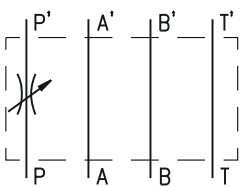

DR6M/32P

ORDERING CODE

DR 6 M / 32 ***

Adjustable throttle

Nominal bore 6mm.

Modular mounting

Rated pressure: up to 320 bar.-32

Valve location: at line T - T
at line P - P

TECHNICAL DATA

Weight	DR6M/32T	0,710 kg
	DR6M/32P	0,710 kg
Max. Pressure		320 bar
Rated flow ($\Delta p=2,5$ bar.)		20 l/min
Working liquid-hydraulic oils with characteristics:		
-viscosity		10...400 cSt
-degree of filtration		0,025 mm
-temperature		-20... +80°C

DESCRIPTION

- ✓ Adjustable throttles with for modular mounting- DR10M/32...
- ✓ The valve throttles , or completely stops the flow in any direction , so creating resistance to flow regulation and support in the hydraulic system.
- ✓ Mounting surface CETOP5 (NG10)

DIMENSIONS

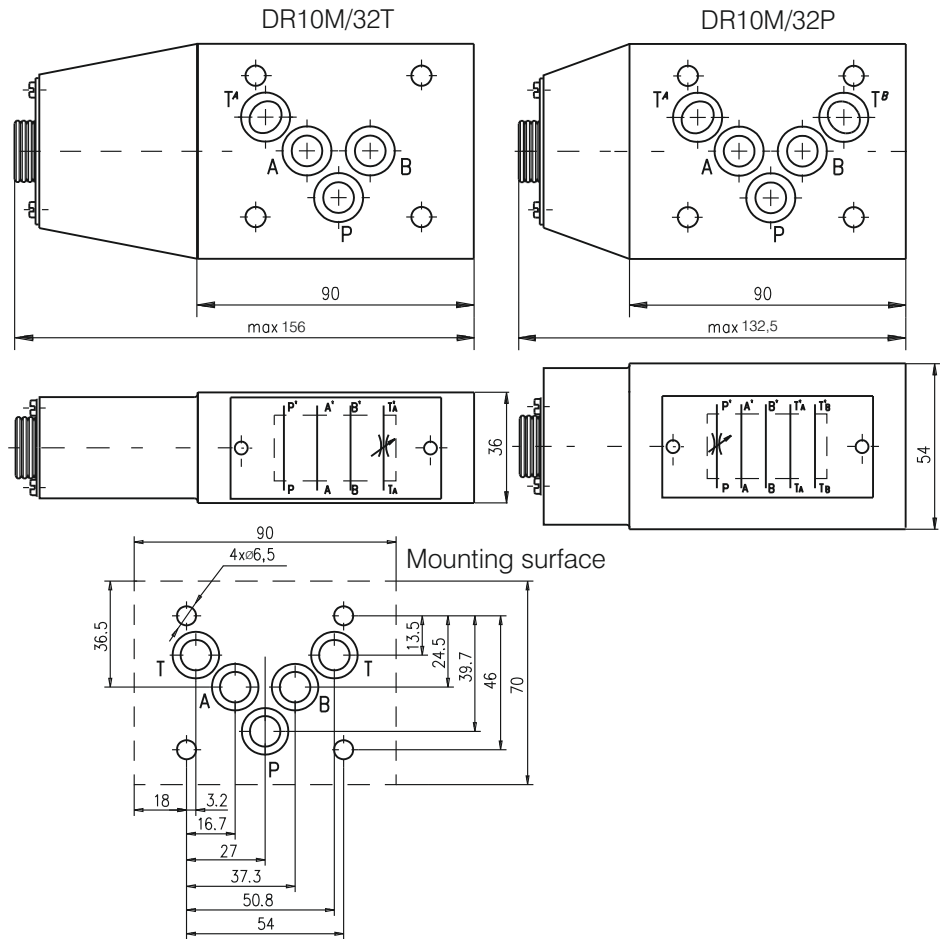

SYMBOL

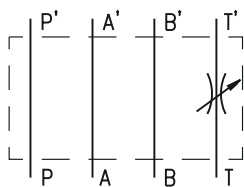

DR10M/32T

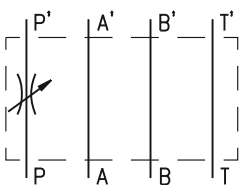

DR10M/32P

ORDERING CODE

DR 10 M / 32 ***

Adjustable throttle

Nominal bore 10mm.

Modular mounting

Rated pressure: up to 320 bar.-32

Valve location: at line T - T
at line P - P

TECHNICAL DATA

Weight	DR10M/32T	2,200 kg
	DR10M/32P	2,850 kg
Max. Pressure		320 bar
Rated flow ($\Delta p=2,5$ bar.)		40 l/min
Working liquid-hydraulic oils with characteristics:		
-viscosity		10...400 cSt
-degree of filtration		0,025 mm
-temperature		-20...+80°C

DESCRIPTION

- ✓ Flow control valves for modular mounting-RD6/2M...
- ✓ The flow control valves are designed to regulate the flow rate in the hydraulic system, independently of the inlet flow and pressure variations in it.
- ✓ Flow Control Valve with solenoid controlled check valve (channel A or channel B) ensures two different speeds of movement.
- ✓ Mounting surface CETOP3 (NG6)

DIMENSIONS

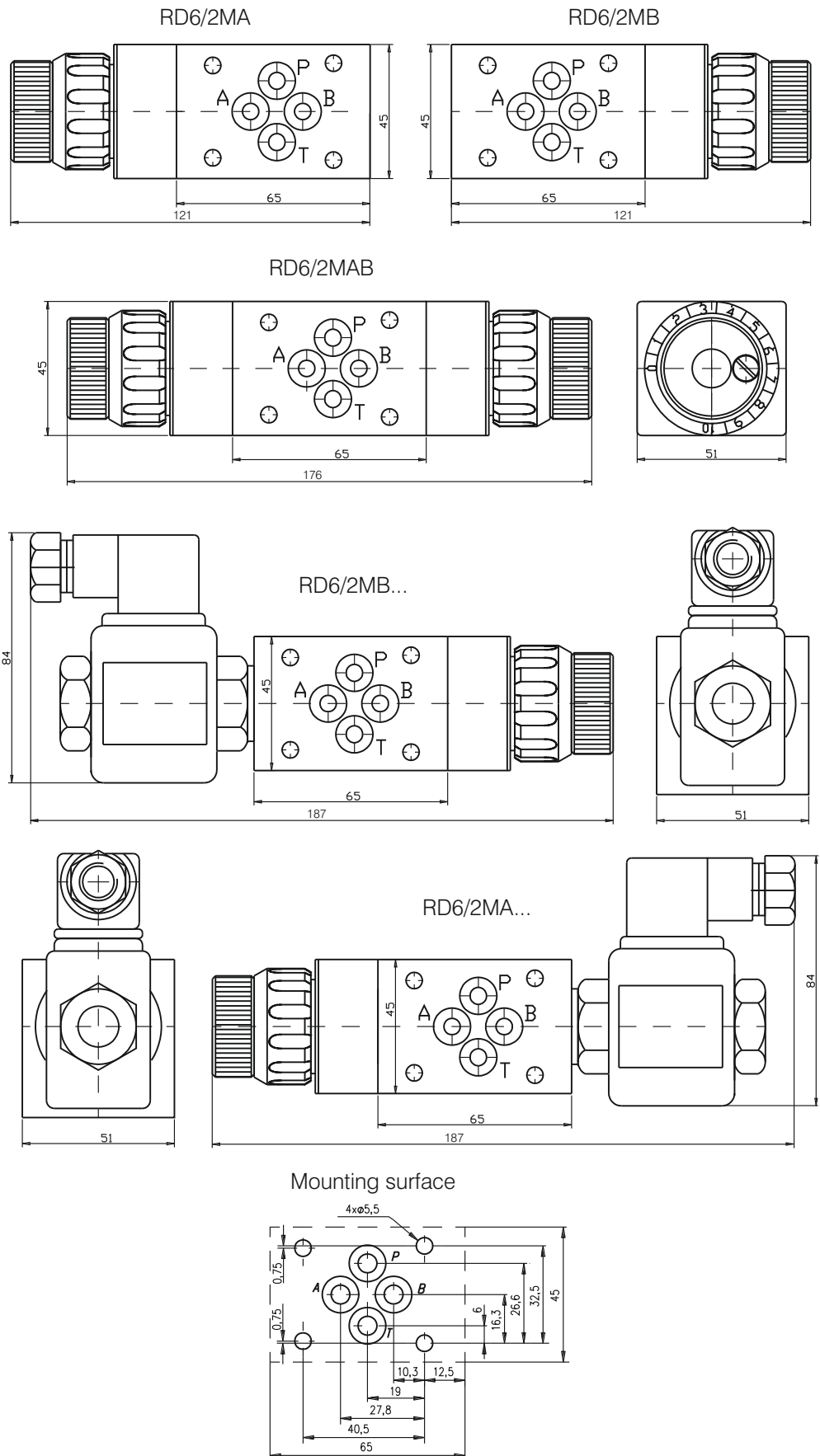

SYMBOL

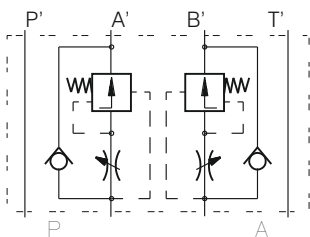

RD6/2MAB

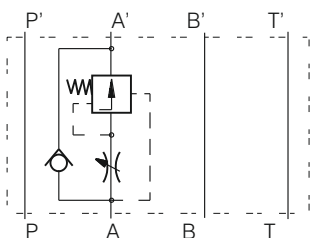

RD6/2MA

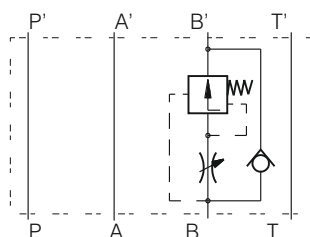

RD6/2MB

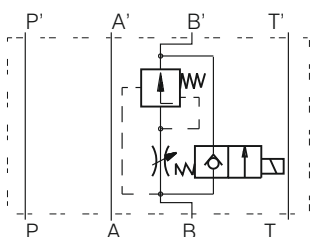

RD6/2MB...

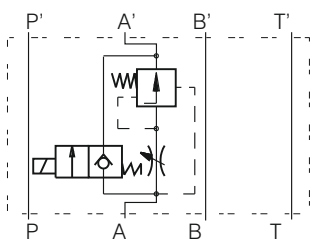

RD6/2MA...

ORDERING CODE

RD 6 / 2 M *** **

Flow control valve

Nominal bore 6mm.

2 - way valve

Modular mounting

Valve position:

at line A - A

at line B - B

at line A&B - AB

Solenoid operated check valve:

- without check valve - omit

-operated voltage 12VDC - 1

-operated voltage 24VDC - 2

-operated voltage 110VAC - 3

-operated voltage 220VAC - 4

TECHNICAL DATA

Weight	RD6/2MAB	1,825 kg
	RD6/2MA & RD6/2MB	1,485 kg
	RD6/2MA...&D6/2MB...	1,885 kg
Max. Pressure		320 bar
	with solenoid valve	250 bar
Rated flow ($\Delta p=2,5$ bar.)		10 l/min
Minimum flow		0,06 l/min
Working liquid-hydraulic oils with characteristics:	-viscosity	10...400 cSt
	-degree of filtration	0,025 mm
	-temperature	-20...+80°C

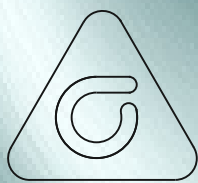

caproni
BULGARIA JOINT-STOCK COMPANY

**BULGARIA , 6100 KAZANLAK , 45 STOLETOV STR.
TEL.:+359/431/62 229 , +359/431/6132 ,
FAX:+359/431/62 230 , +359/431/63 134
E-MAIL:CAPRONI@CAPRONI.BG , WEB:HTTP://WWW.CAPRONI.BG**