



## 1 Company Profile



▶ 5

## 1 New products



▶ 13

## 2 Safety switches with separate actuator



For heavy duty applications

▶ 15



For standard applications

▶ 21

## 3 Magnetic safety sensors



SR series coded magnetic sensors

▶ 27

## 4 Safety sensors with RFID technology



ST series coded sensors with RFID technology

▶ 39

## 5 Safety switches for hinged doors



HP-HC series hinge switches

▶ 49



HX series stainless steel hinge switches

▶ 59



Switches for hinges in heavy duty applications

▶ 69



Switches for hinges in standard applications

▶ 75



Switches with slotted hole lever in standard applications

▶ 81

## 6 Safety switches with separate actuator with lock



With manual mechanical delay

► 91



With key release

► 99



FG series

► 107



FS series

► 121



With RFID technology NG series

► 131

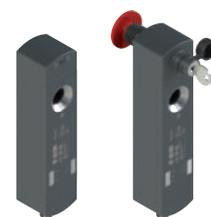

With RFID technology NS series

► 145

## 7 Safety handles

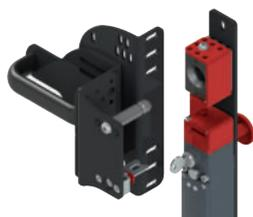

P-KUBE 1 for FD - FG series

► 159



P-KUBE 2 for NG series

► 165



P-KUBE Fast for FD - FG series

► 171



P-KUBE Super for NG series

► 175



P-KUBE Krome for NS series

► 179



P-KUBE Krome for NG series

► 179

## 8 Safety rope switches



With reset for emergency stops  
▶ 191



Safety rope switch without reset for simple stop  
▶ 199



Accessories for rope switches  
▶ 207

## 9 Housings complete with emergency stop buttons



ES series housings complete with emergency buttons  
▶ 211

## 10 Single-function safety modules



Section index  
▶ 213



**10A** For emergency stops and movable guard monitoring CS AR series

▶ 215



**10B** For emergency stops, monitoring of movable guards, safety mats and safety bumpers with 4-wire technology CS AR series

▶ 239



**10C** For emergency stops and movable guard monitoring with delayed contacts CS AT series

▶ 241



**10D** Safety timers CS FS series

► 247



**10E** For two-hand controls or synchronism monitoring CS DM series

► 255



**10F** For motor standstill monitoring CS AM series

► 261



**10G** Expansion modules with output contacts CS ME series

► 263

## 10 Multifunction safety modules



**10H** Programmable multifunction modules CS MP series

► 277



**10I** Pre-programmed multifunction modules CS MF series

► 305

## 11 Accessories



► 321

## 12 Appendix

Utilization requirements	► 337
Contact blocks	► 351
Assembled connectors	► 359
Introduction to safety engineering	► 363
Technical definitions	► 389
General terms and conditions of sale	► 394



## MORE THAN 250 PROFESSIONALS WITH PASSION

It is people, with their professionalism and dedication that make a great company. This profound conviction has always guided Pizzato Elettrica in their choice of employees and partners. Today, Giuseppe and Marco Pizzato lead a tireless team providing the fastest and most efficient response to the demands of the market. This team has grown over the last 10 years and has achieved a considerable increase in sales in all the countries where Pizzato Elettrica is present.

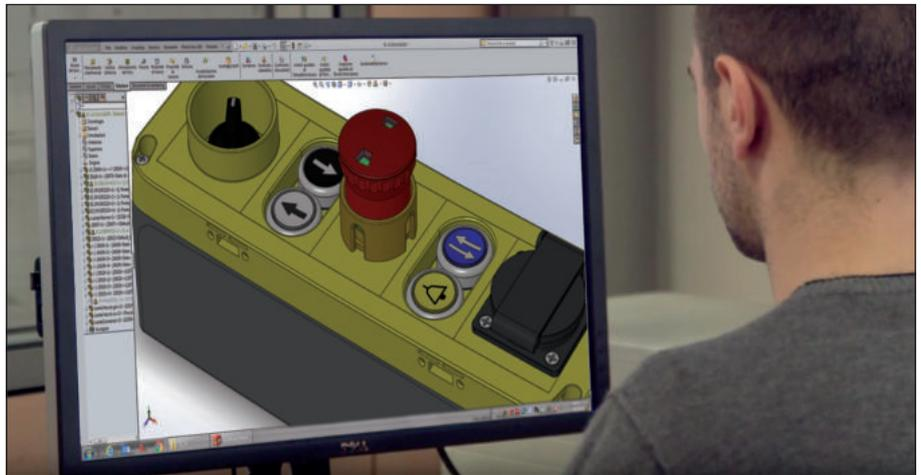

The various strategic sectors of the business are headed by professionals with significant experience and expertise. Many of these people have developed over years with the company. Others are experts in their specific field and have integrated personal experience with the Pizzato Elettrica ethos to extend the company's capability and knowledge.

From the design office to the technical assistance department, from managers to workers, every employee believes in the company and its future. Pizzato Elettrica employees all give the best of themselves secure in the knowledge they are the fundamental elements of a highly valuable enterprise.

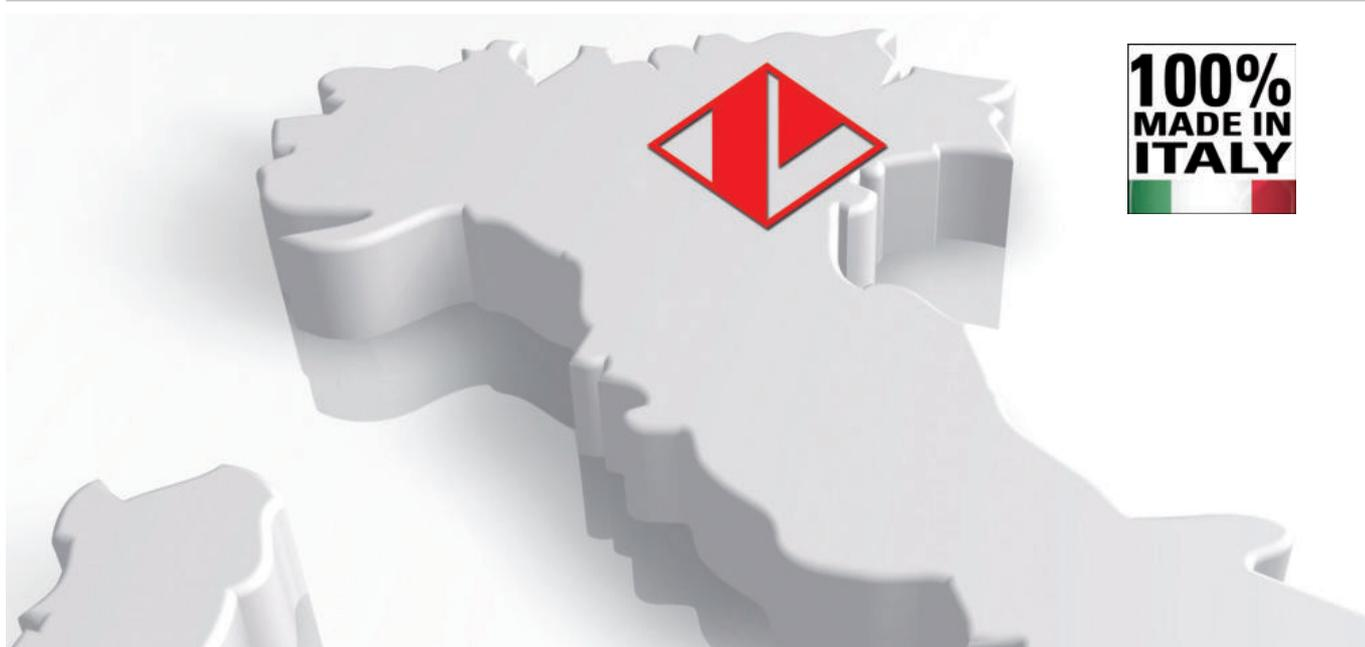

## 100% MADE IN ITALY

Pizzato Elettrica is one of the leading European manufacturers of position switches, microswitches, safety devices, safety modules, foot switches, control and signalling devices, and devices for elevators.

An entrepreneurial company such as Pizzato Elettrica bases its foundations on a solid and widely shared value system. The pillars that form the basis of the company's work have remained constant, and constitute the fundamental guiding principles for all company activities.

### PASSION FOR QUALITY

Passion for product quality, orientation towards excellence, innovation, and continuous development, represent the key principles of Pizzato Elettrica's everyday work.

Anyone using Pizzato Elettrica's products does so in the certainty that these devices are of certified quality, since they are the result of a process that is scrupulously controlled at every stage of the production. The company's goal is to offer the market safe, reliable, and innovative solutions.

### CARE FOR THE CUSTOMER

In order to be successful, a product must respond to the specific needs of those who will use it. Market developments must be carefully monitored in order to understand, in advance, which new applications will prove themselves truly useful. This is why Pizzato Elettrica has always cultivated close synergies with the companies that have chosen it as a supplier, using this continuous dialogue to identify the potential developments of the own product range in order to make it highly flexible, complete and capable to respond to the most diverse needs.

### 100% MADE IN ITALY

All Pizzato Elettrica products are designed, developed, and tested entirely at the company plants in Marostica, in the province of Vicenza in Italy. The company is thus able to meet specific customer requirements at all times, by offering a comprehensive range of products and technologically advanced solutions.









## 86,000,000 PARTS SOLD WORLDWIDE

Pizzato Elettrica's product catalogue contains more than 7,000 articles, with more than 1,500 special codes developed for devices personalised according to clients' specific needs.

Pizzato Elettrica devices can be grouped, according to typology, into three main macro-categories:

- **POSITION SWITCHES.** Pizzato Elettrica position switches are daily installed in every type of industrial machinery all over the world for applications in the sector of wood, metal, plastic, automotive, packaging, lifting, medicinal, naval, etc. In order to be used in a such wide variety of sectors and countries, Pizzato Elettrica position switches are made to be assembled in a lot of configurations thanks to the various body shapes, dozens of contact blocks, hundreds of actuators and materials, forces, assembling versions.

Pizzato Elettrica can offer one of the widest product range of position switches in the world. Moreover, the use of high quality materials, high reliability technologies (e.g. twin bridge contact blocks) as well as the IP67 protection degree make this range of position switches one of the most technologically evolved.

- **SAFETY DEVICES.** The company Pizzato Elettrica has been one of the first Italian companies developing dedicated items for this sector, creating and patenting dozens of innovative products, thus becoming one of the main European manufacturers of safety devices. The vast range of products aimed specifically at the safety of machinery, fully designed and assembled at the Marostica (VI) company premises, ranges from the more traditional safety switches with separate actuator (with or without locking mechanism), hinge switches, and safety handles, to the most modern anti-tampering devices with RFID technology (ST series sensors, NG and NS series locking devices) and stainless steel safety hinge switches with electronic contact block (HX series).

The product range is completed by CS series safety modules, available in single function versions, or user-programmable with the use of the Gemnis Studio software; fully implemented by Pizzato Elettrica and distributed with a free licence.

- **MAN-MACHINE INTERFACE.** Thanks to the introduction of the EROUND control and signalling devices, Pizzato Elettrica has remarkably widened its offer within the man-machine interface sector.

Thanks to the new design, the care for details and the elegance of the product combined with its maximum safety and reliability, this series is one of the most complete and cutting-edge on the market.

In order to satisfy its customers' needs and requests, Pizzato Elettrica offers a lot of accessories purposely designed not only to complete its wide range of products, but also to help device installation on machineries.





## 12 MILLION CERTIFIED PRODUCT CODES

A simple brand isn't enough: the company is aiming for the Pizzato Elettrica brand to be widely recognised as a synonym for absolute quality and certainty.

A result that has been reached and consolidated over the years, updating and expanding the series of certifications obtained from the most important Italian and international control organisations. Product quality is assessed by five accredited external bodies: IMQ, UL, CCC, TÜV SÜD, EAC. These bodies lay out high technical and qualitative standards for the company to achieve and maintain, verified yearly with several inspections: these are performed, without prior notice, by qualified inspectors, who extract samples of products and materials destined for sale from plants, or from the market directly, to subject them to apposite tests.

- **CE MARK.** All Pizzato Elettrica products bear the CE marking in conformity with the European Directives in force.
- **ISO 9001 CERTIFICATION.** The company's production system is compliant with the international ISO 9001 standard, in its most recent 2015 revision. The certification covers all of the company's plants and their production and managerial activities: entry checks, technical, purchasing and commercial department activities, manufacturing operations assessments, final pre-shipping product tests and checks, equipment reviews and the management of the metrological lab.  
The Pizzato Elettrica quality management system ensures that all sensitive company processes – from component design to implementation, from materials provisioning to verification of non-compliant products – are carried out according to the procedures laid down, with the aim of providing our customers with continuously improved and reliable products.
- **CERTIFICATION OF COMPANY QUALITY SYSTEMS.** Pizzato Elettrica has obtained the certificate of compliance with the UNI EN ISO 9000 regulations in force in Italy and abroad. It is issued by a recognised independent body that guarantees the quality and reliability of the service offered to clients worldwide.
- **CSQ, CISQ AND IQNET.** The CSQ system is part of the CISQ (Italian Certification of Quality Systems) federation, which consists of the primary certification bodies operating in Italy in the various product sectors. CISQ is the Italian representative body within IQNet, the biggest international Quality Systems and Company Management certification network, which is adhered to by 25 certification organs in as many countries.





## GLOBAL SUBSIDIARIES

The two-year period from 2017 - 2018 saw the birth of two new commercial subsidiaries: Pizzato Iberica SL and Pizzato USA Inc. In addition to the Spanish and American subsidiaries, the German subsidiary, Pizzato Deutschland GmbH, was founded in 2013, and the French subsidiary, Pizzato France Sarl, was founded in 2016.

The purpose of these subsidiaries is to coordinate and support the activities of representative agencies, or distributors, active in the various countries, providing the best possible management of marketing and commercial activities, with the ultimate aim of increasing brand visibility, and the penetration ability of Pizzato Elettrica products in markets considered strategic.

Products from Pizzato Elettrica are currently used in over 80 countries: The commercial support network, which is made up of local professional and experienced representatives, combined with the productive capacity of the headquarters in Italy, are the basis for the formation of a group that, together with its partners, has all the necessary requirements to become one of the most important companies in the field of automation and industrial safety.

## TECHNICAL AND SALES ASSISTANCE



### TECHNICAL DEPARTMENT

The Pizzato Elettrica technical department provides direct technical and qualified assistance in Italian and English, helping in this way the customers to choose the suitable product for their own application explaining the characteristics and the correct installation.

Office hours: Monday to Friday  
08 am - 12 pm / 02 pm - 06 pm CET

Telephone: +39.0424.470.930

E-mail: [tech@pizzato.com](mailto:tech@pizzato.com)

Spoken languages:  

### SALES DEPARTMENT

Among the strengths in the company relationship with the commercial network, the direct assistance guaranteed in five languages: Italian, English, French, German and Spanish. A service that confirms Pizzato Elettrica quality and attention to the needs of customers from around the world.

Office hours: Monday to Friday  
08 am - 12 pm / 02 pm - 06 pm CET

Telephone: +39.0424.470.930

E-mail: [info@pizzato.com](mailto:info@pizzato.com)

Spoken languages:     





## TRADE FAIRS AND EVENTS

### TRADE FAIRS

Pizzato Elettrica regularly participate to many trade fairs in Italy and abroad, presenting in this way to the market the products, the latest news, etc.

### EVENTS

Besides offering qualified technical assistance, Pizzato Elettrica presents itself as a dynamic partner who is attentive to the needs of its customers. For this reason, the company organises several meetings and training courses with particular attention to the regulatory aspect of machinery safety.



## WEBSITE WWW.PIZZATO.COM

### PRODUCT NEWS

Visit the website at [www.pizzato.com](http://www.pizzato.com) to stay updated on all the news regarding product launches, to view the entire range of products created by Pizzato Elettrica, and to consult all the documentation provided.

### SEARCH USING FILTERS

You can find the product you want by entering the relative item code, or use the filters provided to create the item most adapted to your particular requirements, by choosing the features it needs to offer.

### BROWSABLE, DOWNLOADABLE CATALOGUE

Users can download the complete catalogue or alternatively browse it directly online, an extremely handy solution for those wishing to consult the range of products simply and rapidly.

### HIGH RESOLUTION IMAGES

The information provided for each product is complete with high resolution images to offer visitors to the website a clear, accurate view of the items in close detail, also offering them the possibility to zoom in and out on the image.

### USAGE INSTRUCTIONS

You can download product usage or installation instructions, in PDF format, to your computer.

### 2D AND 3D FILES

2D and 3D drawings are available for every item; in formats that are compatible with the widest variety of drawing programs.

### CERTIFICATES AND EC DECLARATIONS OF CONFORMITY

The latest product type approval certificates, and EC declarations of conformity in accordance with applicable European product directives, are published on the website.

### LARGE VIDEO SECTION

The large video section of the website is capable of showcasing the main characteristics, functions and use of the various products.



### P-KUBE Krome safety handles

- Compatible with NS and NG series RFID safety switches with lock
- System suitable for use with hinged and sliding doors, either with right or left closing
- Internal steel fixing plate, thickness 5 mm
- Versions with chrome-plated or illuminated grip
- Customizable multicolour lighting with RGB LED technology
- On request with push button or other integrated control device
- Protection caps on the holes of the fixing screws
- Modern and ergonomic design

► 179



### P-KUBE Super safety handles

- Compatible with NG series RFID safety switches with lock
- Suitable for heavy-duty guards and heavy-duty work environments
- System suitable for use with hinged and sliding doors, either with right or left closing
- Dual centring pin
- Integrated lock out device
- Thanks to the slotted brackets the handle can be adjusted on 3 different axes
- Extremely robust painted metal brackets

► 175



### LK S lock out device for NS series RFID safety switches with lock

- Made entirely of metal
- Fixing to the holes of the NS switch with only 2 tamper-proof screws
- Dual safety: mechanical closure of the actuator entry hole and shielding of the RFID signal
- Possibility of applying up to 5 padlocks
- Compatible with the new P-KUBE Krome handles

► 185



### NS and NG series RFID safety switches with lock with mode 3

- 3 different actuation modes for safety outputs
- In mode 3 one safety output is active with inserted and locked actuator, the second safety output is active with inserted actuator
- Alternative solution to electromechanical devices, without the need to change the wiring and operating logic of existing machines
- TÜV and cULus approval



## ST series safety sensors with RFID technology

- SIL 3/PL e/category 4 with a single device
- Maximum PL e/SIL 3 safety level can be maintained with series connection of up to 32 devices
- Protection degrees IP67 and IP69K
- Two actuation distances: 12 mm and 20 mm
- New compact SM L•T actuators
- Version with EDM (External Device Monitoring)
- TÜV and cULus approval

► 39



## CS MP series programmable multifunction modules

- New module configurations available
- New models with 8 safety outputs
- New release 11.7.1.0 of the Gemnis Studio software:
  - SERIAL function block for communication with PLC
  - Program migration tool
  - Improved graphics

► 277



## ECOLAB certification

The devices of the NG, NS and ST series are now ECOLAB-certified, i.e. resistant and chemically compatible with the hygiene and cleaning products commonly used in the food & beverage industry.

The results from immersion tests in detergents/disinfectants carried out in ECOLAB laboratories testify to the high quality and versatility of these products.



## Stock items

As of the publication of the general catalogue 2019-2020, a list of items in stock will be available at [www.pizzato.com](http://www.pizzato.com)

Selection diagram

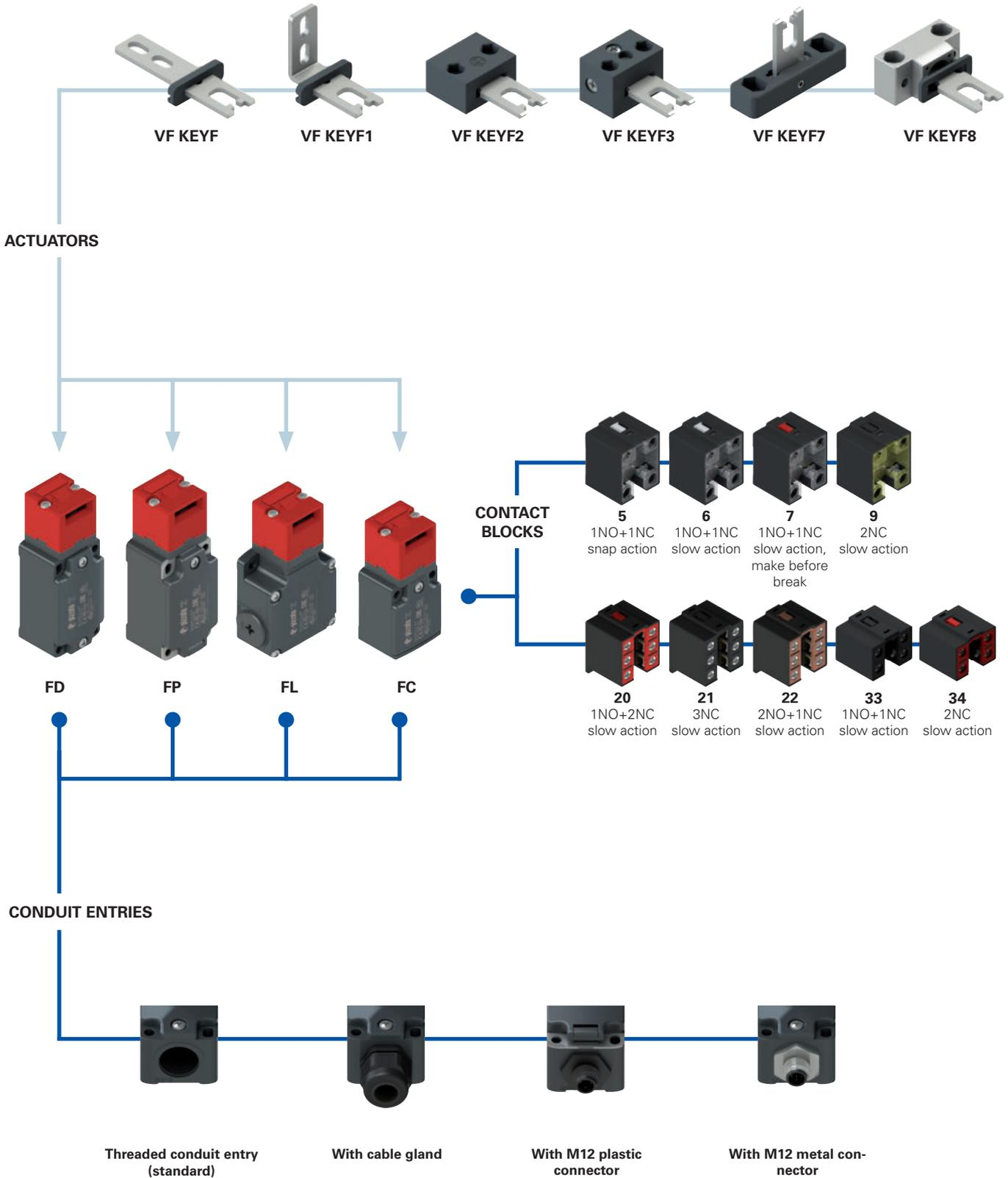

● product option  
 → sold separately as accessory





**Code structure** **Attention!** The feasibility of a code number does not mean the effective availability of a product. Please contact our sales office.

article options options  
**FD 693-F1GM2K50T6**

Housing	
<b>FD</b>	metal, one conduit entry
<b>FL</b>	metal, three conduit entries
<b>FP</b>	technopolymer, one conduit entry

Contact blocks	
<b>5</b>	1NO+1NC, snap action
<b>6</b>	1NO+1NC, slow action
<b>7</b>	1NO+1NC, slow action, make before break
<b>9</b>	2NC, slow action
<b>20</b>	1NO+2NC, slow action
<b>21</b>	3NC, slow action
<b>22</b>	2NO+1NC, slow action
<b>33</b>	1NO+1NC, slow action
<b>34</b>	2NC, slow action

Actuators	
	without actuator (standard)
<b>F</b>	straight actuator VF KEYF
<b>F1</b>	angled actuator VF KEYF1
<b>F2</b>	jointed actuator VF KEYF2
<b>F3</b>	jointed actuator adjustable in two directions VF KEYF3
<b>F7</b>	jointed actuator adjustable in one direction VF KEYF7
<b>F8</b>	universal actuator VF KEYF8

Ambient temperature	
	-25°C ... +80°C (standard)
<b>T6</b>	-40°C ... +80°C

Pre-installed cable glands or connectors	
	no cable gland or connector (standard)
<b>K23</b>	cable gland for cables Ø 6 ... 12 mm
...	.....
<b>K50</b>	M12 metal connector, 5-pole
...	.....

For the complete list of possible combinations please contact our technical department.

Threaded conduit entry	
<b>M2</b>	M20x1.5 (standard)
	PG13.5

Contact type	
	silver contacts (standard)
<b>G</b>	silver contacts with 1 µm gold coating
<b>G1</b>	silver contacts, 2.5 µm gold coating (not for contact blocks 20, 21, 22, 33, 34)

article options options  
**FC 3393-F1GM2K50T6**

Housing	
<b>FC</b>	metal, one conduit entry

Contact blocks	
<b>33</b>	1NO+1NC, slow action
<b>34</b>	2NC, slow action

Actuators	
	without actuator (standard)
<b>F</b>	straight actuator VF KEYF
<b>F1</b>	angled actuator VF KEYF1
<b>F2</b>	jointed actuator VF KEYF2
<b>F3</b>	jointed actuator adjustable in two directions VF KEYF3
<b>F7</b>	jointed actuator adjustable in one direction VF KEYF7
<b>F8</b>	universal actuator VF KEYF8

Ambient temperature	
	-25°C ... +80°C (standard)
<b>T6</b>	-40°C ... +80°C

Pre-installed cable glands or connectors	
	no cable gland (standard)
<b>K23</b>	cable gland for cables Ø 6 ... 12 mm
<b>K50</b>	M12 metal connector, 5-pole

Threaded conduit entry	
<b>M2</b>	M20x1.5 (standard)
	PG11

Contact type	
	silver contacts (standard)
<b>G</b>	silver contacts with 1 µm gold coating

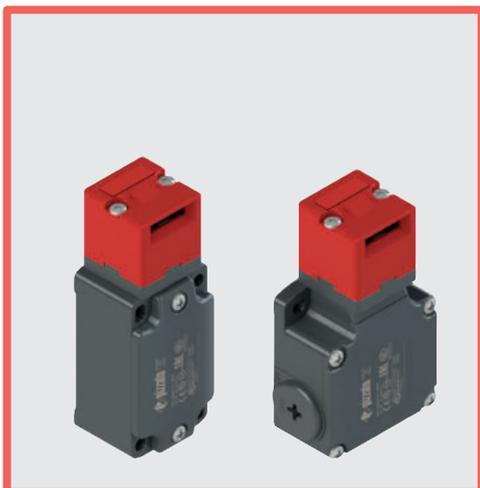

### Main features

- Metal housing or technopolymer housing, from one to three conduit entries
- Protection degree IP67
- 9 contact blocks available
- 6 stainless steel actuators available
- Versions with M12 connector
- Versions with gold-plated silver contacts

### Quality marks:



IMQ approval:	EG605
UL approval:	E131787
CCC approval:	2007010305230000
EAC approval:	RU C-IT.YT03.B.00035/19

### Technical data

#### Housing

FP series housing made of glass fibre reinforced technopolymer, self-extinguishing, shock-proof and with double insulation: 

FD, FL and FC series: metal housing, baked powder coating.

Metal head, baked powder coating.

FD, FP, FC series: one threaded conduit entry: M20x1.5 (standard)

FL series: three threaded conduit entries: M20x1.5 (standard)

Protection degree: IP67 acc. to EN 60529 with cable gland of equal or higher protection degree

#### General data

SIL (SIL CL) up to:	SIL 3 acc. to EN 62061
Performance Level (PL) up to:	PL e acc. to EN ISO 13849-1
Mechanical interlock, coded:	type 2 acc. to EN ISO 14119
Coding level:	low acc. to EN ISO 14119
Safety parameter $B_{10D}$ :	2,000,000 for NC contacts
Mission time:	20 years
Ambient temperature:	-25°C ... +80°C (standard) -40°C ... +80°C (T6 option)
Max. actuation frequency:	3600 operating cycles/hour
Mechanical endurance:	1 million operating cycles
Max. actuation speed:	0.5 m/s
Min. actuation speed:	1 mm/s
Tightening torques for installation:	see page 339
Wire cross-sections and wire stripping lengths:	see page 357

#### In compliance with standards:

IEC 60947-5-1, IEC 60947-1, IEC 60204-1, EN ISO 14119, EN ISO 12100, IEC 60529, EN 50581, BG-GS-ET-15, UL 508, CSA 22.2 No.14

#### Approvals:

EN 60947-5-1, UL 508, CSA 22.2 No.14, GB/T14048.5-2017.

#### Compliance with the requirements of:

Machinery Directive 2006/42/EC, EMC Directive 2014/30/EU, RoHS Directive 2011/65/EU.

#### Positive contact opening in conformity with standards:

IEC 60947-5-1, EN 60947-5-1.

**⚠ If not expressly indicated in this chapter, for correct installation and utilization of all articles see the instructions given on pages 337 to 350.**

	Electrical data	Utilization category
without connector	Thermal current ( $I_{th}$ ):	10 A
	Rated insulation voltage (U):	500 Vac 600 Vdc 400 Vac 500 Vdc (contact blocks 20, 21, 22, 33, 34)
	Rated impulse withstand voltage ( $U_{imp}$ ):	6 kV 4 kV (contact blocks 20, 21, 22, 33, 34)
	Conditional short circuit current: Protection against short circuits: Pollution degree:	1000 A acc. to EN 60947-5-1 type aM fuse 10 A 500 V 3
with M12 connector, 4 or 5-pole	Thermal current ( $I_{th}$ ):	4 A
	Rated insulation voltage (U):	250 Vac 300 Vdc
	Protection against short circuits: Pollution degree:	type gG fuse 4 A 500 V 3
		Alternating current: AC15 (50÷60 Hz) $U_e$ (V) 24 120 250 $I_e$ (A) 4 4 4 Direct current: DC13 $U_e$ (V) 24 125 250 $I_e$ (A) 3 0.55 0.3
with M12 connector, 8-pole	Thermal current ( $I_{th}$ ):	2 A
	Rated insulation voltage (U):	30 Vac 36 Vdc
	Protection against short circuits: Pollution degree:	type gG fuse 2 A 500 V 3
		Alternating current: AC15 (50÷60 Hz) $U_e$ (V) 24 $I_e$ (A) 2 Direct current: DC13 $U_e$ (V) 24 $I_e$ (A) 2

## Description



These safety switches are ideal for controlling gates, sliding doors and other guards which protect dangerous parts of machines without inertia.

The stainless steel actuator is fastened to the moving part of the guard in such a way that it is separated from the switch each time the guard is opened. A special mechanism ensures that removing the actuator forces the positive opening of the electrical contacts. Easy to install, these switches can be used with all types of guards (with hinge as well as sliding and removable types). The possibility to actuate the switch only with a specific actuator guarantees that the machine can be restarted only after the guard has been closed. These switches are made of robust materials with larger dimensions and are designed especially for heavy gates and harsh environments.

## Head with variable orientation

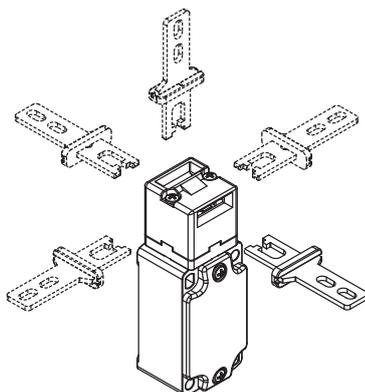

For all switches, the head can be adjusted in 90° steps after removing the two fastening screws. In this way it is possible to actuate the switch from 5 different directions.

## Wide-ranging actuator travel

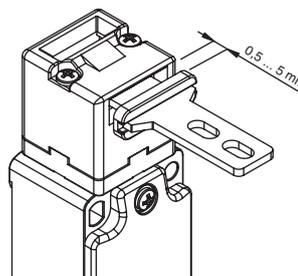

The actuation head of this switch features a wide range of travel. In this way the guard can oscillate along the direction of insertion (4.5 mm) without causing unwanted machine shutdowns. This wide range of travel is available in all actuators in order to ensure maximum device reliability.

## Protection degree IP67

# IP67

These devices are designed to be used in the toughest environmental conditions and they pass the IP67 immersion test acc. to EN 60529. They can therefore be used in all environments where maximum protection degree of the housing is required.

## Safety screws for actuators

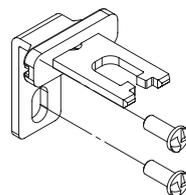

As required by EN ISO 14119, the actuator must be fixed immovably to the guard frame. Pan head safety screws with one-way fitting are available for this purpose. With this screw type, the actuators cannot be removed or tampered by using common tools. See accessories on page 332.

## Extended temperature range

# -40°C

These devices are also available in a special version suitable for an ambient operating temperature range from -40°C up to +80°C.

They can therefore be used for applications in cold stores, sterilisers and other equipment with low temperature environments. The special materials used to produce these versions retain their characteristics even under these conditions, thereby expanding the installation possibilities.

## Laser engraving



All devices are marked using a dedicated indelible laser system. These engravings are therefore suitable for extreme environments too. Thanks to this system that does not use labels, the loss of plate data is prevented and a greater resistance of the marking is achieved over time.

## Features approved by IMQ

Rated insulation voltage (U <sub>i</sub> ):	500 Vac 400 Vac (for contact blocks 20, 21, 22, 33, 34)
Conventional free air thermal current (I <sub>th</sub> ):	10 A
Protection against short circuits:	type aM fuse 10 A 500 V
Rated impulse withstand voltage (U <sub>imp</sub> ):	6 kV 4 kV (for contact blocks 20, 21, 22, 33, 34)
Protection degree of the housing:	IP67
MV terminals (screw terminals)	
Pollution degree:	3
Utilization category:	AC15
Operating voltage (U <sub>e</sub> ):	400 Vac (50 Hz)
Operating current (I <sub>e</sub> ):	3 A

Forms of the contact element: Zb, Y+Y, Y+Y+X, Y+Y+Y, Y+X+X

Positive opening contacts on contact blocks 5, 6, 7, 9, 20, 21, 22, 33, 34

In compliance with standards: EN 60947-1, EN 60947-5-1, fundamental requirements of the Low Voltage Directive 2014/35/EU.

## Features approved by UL

Electrical Ratings:	Q300 pilot duty (69 VA, 125-250 V dc) A600 pilot duty (720 VA, 120-600 V ac)
---------------------	---

Environmental Ratings: Types 1, 4X, 12, 13

Use 60 or 75 °C copper (Cu) conductor and wire size range 12, 14 AWG, stranded or solid. The terminal tightening torque of 7.1 lb in (0.8 Nm).

For FP series: the hub is to be connected to the conduit before the hub is connected to the enclosure.

**Please contact our technical department for the list of approved products.**

Please contact our technical department for the list of approved products.

Contact type:

- R** = snap action
- L** = slow action
- LO** = slow action, make before break

	Technopolymer housing Without actuator	Metal housing Without actuator	Metal housing Without actuator	Metal housing Without actuator
5	<b>R</b> FP 593-M2 ⊕ 1NO+1NC 	FD 593-M2 ⊕ 1NO+1NC 	FL 593-M2 ⊕ 1NO+1NC 	/
6	<b>L</b> FP 693-M2 ⊕ 1NO+1NC 	FD 693-M2 ⊕ 1NO+1NC 	FL 693-M2 ⊕ 1NO+1NC 	/
7	<b>LO</b> FP 793-M2 ⊕ 1NO+1NC 	FD 793-M2 ⊕ 1NO+1NC 	FL 793-M2 ⊕ 1NO+1NC 	/
9	<b>L</b> FP 993-M2 ⊕ 2NC 	FD 993-M2 ⊕ 2NC 	FL 993-M2 ⊕ 2NC 	/
20	<b>L</b> FP 2093-M2 ⊕ 1NO+2NC 	FD 2093-M2 ⊕ 1NO+2NC 	FL 2093-M2 ⊕ 1NO+2NC 	/
21	<b>L</b> FP 2193-M2 ⊕ 3NC 	FD 2193-M2 ⊕ 3NC 	FL 2193-M2 ⊕ 3NC 	/
22	<b>L</b> FP 2293-M2 ⊕ 2NO+1NC 	FD 2293-M2 ⊕ 2NO+1NC 	FL 2293-M2 ⊕ 2NO+1NC 	/
33	<b>L</b> FP 3393-M2 ⊕ 1NO+1NC 	FD 3393-M2 ⊕ 1NO+1NC 	FL 3393-M2 ⊕ 1NO+1NC 	FC 3393-M2 ⊕ 1NO+1NC 
34	<b>L</b> FP 3493-M2 ⊕ 2NC 	FD 3493-M2 ⊕ 2NC 	FL 3493-M2 ⊕ 2NC 	FC 3493-M2 ⊕ 2NC 
Actuating force	10 N (18 N ⊕)	10 N (18 N ⊕)	10 N (18 N ⊕)	10 N (18 N ⊕)

## How to read travel diagrams

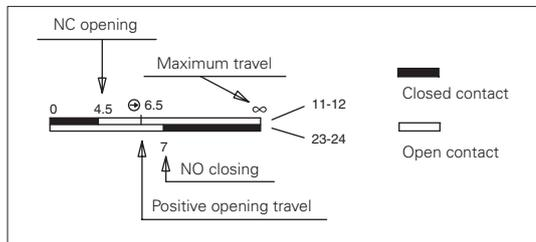

### IMPORTANT:

The state of the NC contact refers to the switch with inserted actuator. In **safety applications**, actuate the switch **at least up to the positive opening travel** shown in the travel diagrams with symbol ⊕. Actuate the switch **at least with the positive opening force**, reported in brackets below each article, next to the actuating force value.

## Limits of use

- Do not use where dust and dirt may penetrate in any way into the head and deposit there. In particular where metal dust, concrete or chemicals are spread.
- Adhere to the EN ISO 14119 requirements regarding low level of coding for interlocks.
- Do not use in environments with presence of explosive or flammable gases or dusts. In these cases use ATEX products (see dedicated Pizzato catalogue).



Selection diagram

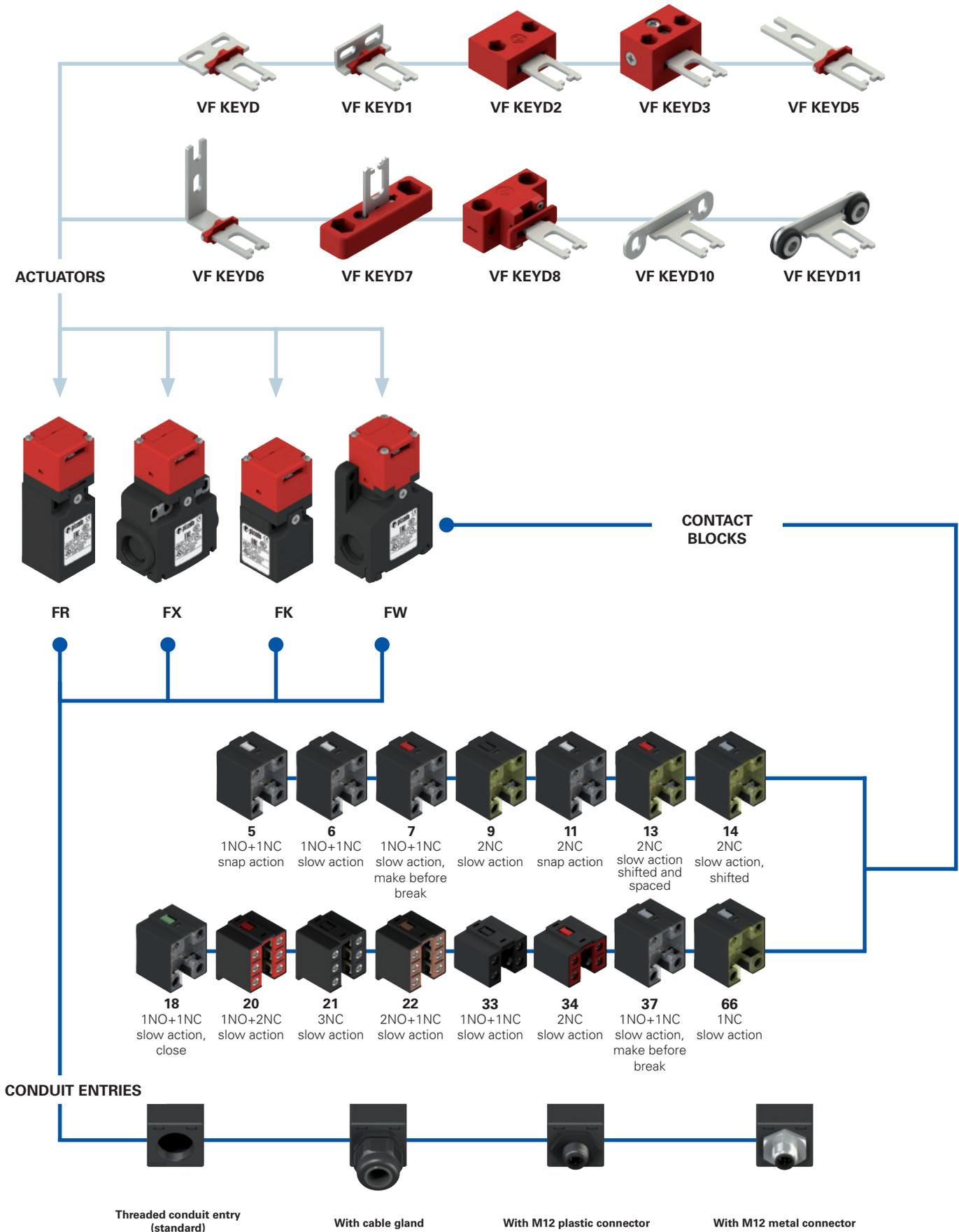

—●— product option  
 —>— sold separately as accessory



**Code structure** **Attention!** The feasibility of a code number does not mean the effective availability of a product. Please contact our sales office.

article options options  
**FR 693-E3D1XGM2K70T6**

Housing	
<b>FR</b>	technopolymer, one conduit entry
<b>FX</b>	technopolymer, two conduit entries
<b>FW</b>	technopolymer, three conduit entries

Ambient temperature	
	-25°C ... +80°C (standard)
<b>T6</b>	-40°C ... +80°C

Contact blocks	
<b>5</b>	1NO+1NC, snap action
<b>6</b>	1NO+1NC, slow action
<b>7</b>	1NO+1NC, slow action, make before break
<b>9</b>	2NC, slow action
<b>11</b>	2NC, snap action
<b>13</b>	2NC, slow action, shifted and spaced
<b>14</b>	2NC, slow action, shifted
<b>18</b>	1NO+1NC, slow action, close
<b>20</b>	1NO+2NC, slow action
<b>21</b>	3NC, slow action
<b>22</b>	2NO+1NC, slow action
<b>33</b>	1NO+1NC, slow action
<b>34</b>	2NC, slow action
<b>37</b>	1NO+1NC, slow action, make before break
<b>66</b>	1NC, slow action

Pre-installed cable glands or connectors	
	no cable gland or connector (standard)
<b>K23</b>	cable gland for cables Ø 6 ... 12 mm
...	.....
<b>K70</b>	M12 plastic connector, 4-pole
...	.....

For the complete list of possible combinations please contact our technical department.

Threaded conduit entry	
<b>M2</b>	M20x1.5 (standard)
<b>M1</b>	M16x1.5
	PG 13.5 (FR-FX housing only)
<b>A</b>	PG 11 (FR-FX housing only)

Contact type	
	silver contacts (standard)
<b>G</b>	silver contacts with 1 µm gold coating
<b>G1</b>	silver contacts, 2.5 µm gold coating (not for contact blocks 20, 21, 22, 33, 34)

Head type	
<b>92</b>	detachable head (FW housing only)
<b>93</b>	non-detachable head (FR, FX and FK housing only)

External metallic parts	
	zinc-plated steel (standard)
<b>X</b>	stainless steel

Actuator extraction force	
	10 N (standard)
<b>E3</b>	30 N

Actuators	
	without actuator (standard)
<b>D</b>	straight actuator VF KEYD
<b>D1</b>	angled actuator VF KEYD1
<b>D2</b>	jointed actuator VF KEYD2
...	.....

article options options  
**FK 3393-E3D1XGM1K24T6**

Housing	
<b>FK</b>	technopolymer, one conduit entry

Ambient temperature	
	-25°C ... +80°C (standard)
<b>T6</b>	-40°C ... +80°C

Contact blocks	
<b>33</b>	1NO+1NC, slow action
<b>34</b>	2NC, slow action

Pre-installed cable glands	
	no cable gland (standard)
<b>K24</b>	cable gland for cables Ø 10 ... 5 mm
<b>K28</b>	cable gland for cables Ø 3 ... 7°mm

Actuator extraction force	
	10 N (standard)
<b>E3</b>	30 N

Actuators	
	without actuator (standard)
<b>D</b>	straight actuator VF KEYD
<b>D1</b>	angled actuator VF KEYD1
<b>D2</b>	jointed actuator VF KEYD2
...	.....

Threaded conduit entry	
<b>M1</b>	M16x1.5(standard)
	PG 11

External metallic parts	
	zinc-plated steel (standard)
<b>X</b>	stainless steel

Contact type	
	silver contacts (standard)
<b>G</b>	silver contacts with 1 µm gold coating

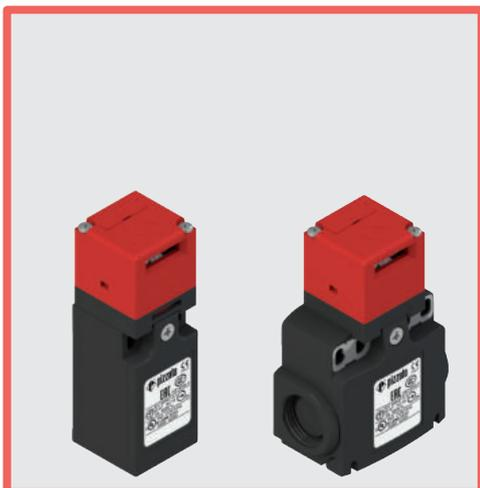

### Main features

- Technopolymer housing, from one to three conduit entries
- Protection degree IP67
- 15 contact blocks available
- 10 stainless steel actuators available
- Versions with M12 connector
- Versions with gold-plated silver contacts

### Quality marks:



IMQ approval:	EG610
UL approval:	E131787
CCC approval:	2007010305230013
EAC approval:	RU C-IT.YT03.B.00035/19

### Technical data

#### Housing

Housing made of glass fibre reinforced technopolymer, self-extinguishing, shock-proof and with double insulation:   
 FR series, one conduit entry: M20x1.5 (standard)   
 FK series: one threaded conduit entry: M16x1.5 (standard)   
 FX series: two knock-out threaded conduit entries: M20x1.5 (standard)   
 FW series: three knock-out threaded conduit entries: M20x1.5 (standard)   
 Protection degree: IP67 acc. to EN 60529 with cable gland of equal or higher protection degree

#### General data

SIL (SIL CL) up to:	SIL 3 acc. to EN 62061
Performance Level (PL) up to:	PL e acc. to EN ISO 13849-1
Mechanical interlock, coded:	type 2 acc. to EN ISO 14119
Coding level:	low acc. to EN ISO 14119
Safety parameter $B_{10D}$ :	2,000,000 for NC contacts
Mission time:	20 years
Ambient temperature:	-25°C ... +80°C (standard) -40°C ... +80°C (T6 option)
Max. actuation frequency:	3600 operating cycles/hour
Mechanical endurance:	1 million operating cycles
Max. actuation speed:	0.5 m/s
Min. actuation speed:	1 mm/s
Actuator extraction force:	10 N (-E3 versions: 30 N)
Tightening torques for installation:	see page 341
Wire cross-sections and wire stripping lengths:	see page 357

#### In compliance with standards:

IEC 60947-5-1, IEC 60947-1, IEC 60204-1, EN ISO 14119, EN ISO 12100, IEC 60529, EN 50581, BG-GS-ET-15, UL 508, CSA 22.2 No.14

#### Approvals:

EN 60947-5-1, UL 508, CSA 22.2 No.14, GB/T14048.5-2017.

#### Compliance with the requirements of:

Machinery Directive 2006/42/EC, EMC Directive 2014/30/EU, RoHS Directive 2011/65/EU.

#### Positive contact opening in conformity with standards:

IEC 60947-5-1, EN 60947-5-1.

If not expressly indicated in this chapter, for correct installation and utilization of all articles see the instructions given on pages 337 to 350.

	Electrical data	Utilization category
without connector	Thermal current ( $I_{th}$ ):	10 A
	Rated insulation voltage ( $U_i$ ):	500 Vac 600 Vdc 400 Vac 500 Vdc (contact blocks 20, 21, 22, 33, 34)
	Rated impulse withstand voltage ( $U_{imp}$ ):	6 kV 4 kV (contact blocks 20, 21, 22, 33, 34)
with M12 connector, 4-pole	Thermal current ( $I_{th}$ ):	4 A
	Rated insulation voltage ( $U_i$ ):	250 Vac 300 Vdc
	Protection against short circuits:	type gG fuse 4 A 500 V
with M12 connector, 8-pole	Thermal current ( $I_{th}$ ):	2 A
	Rated insulation voltage ( $U_i$ ):	30 Vac 36 Vdc
	Protection against short circuits:	type gG fuse 2 A 500 V
	Pollution degree:	3
		Alternating current: AC15 (50±60 Hz)
		$U_e$ (V) 250 400 500
		$I_e$ (A) 6 4 1
		Direct current: DC13
		$U_e$ (V) 24 125 250
		$I_e$ (A) 3 0.55 0.3
		Alternating current: AC15 (50±60 Hz)
		$U_e$ (V) 24 120 250
		$I_e$ (A) 4 4 4
		Direct current: DC13
		$U_e$ (V) 24 125 250
		$I_e$ (A) 3 0.55 0.3
		Alternating current: AC15 (50±60 Hz)
		$U_e$ (V) 24
		$I_e$ (A) 2
		Direct current: DC13
		$U_e$ (V) 24
		$I_e$ (A) 2





## Description



These safety switches are ideal for controlling gates, sliding doors and other guards which protect dangerous parts of machines without inertia. The stainless steel actuator is fastened to the moving part of the guard in such a way that it is separated from the switch each time the guard is opened. A special mechanism ensures that removing the actuator forces the positive opening of the electrical contacts. Easy to install, these switches can be used with all types of guards (with hinge as well as sliding and removable types). The possibility to actuate the switch only with a specific actuator guarantees that the machine can be restarted only after the guard has been closed.

## Head with variable orientation

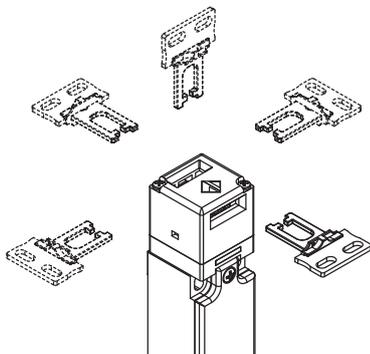

For all switches, the head can be adjusted in 90° steps after removing the two fastening screws. In this way it is possible to actuate the switch from 5 different directions.

## Wide-ranging actuator travel

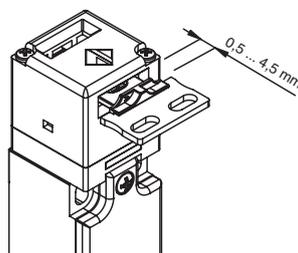

The actuation head of this switch features a wide range of travel. In this way the guard can oscillate along the direction of insertion (4 mm) without causing unwanted machine shut-downs. This wide range of travel is available in all actuators in order to ensure maximum device reliability.

## Not detachable head

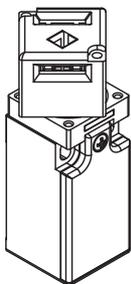

To make head adjustment safer and smoother, these switches are equipped with a special head to body coupling system. This system makes it impossible to remove the head from the device even during adjustment, thus rendering the use of one-way screws unnecessary for locking the head in position once adjustment is complete. This solution is available for the FR, FX and FK series.

## Versions with 30 N actuator extraction force

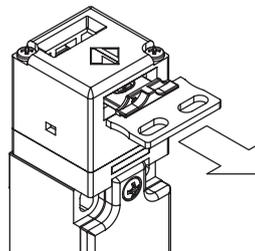

Versions with 30 N actuator holding force instead of the standard 10 N are available.

## Protection degree IP67

# IP67

These devices are designed to be used in the toughest environmental conditions and they pass the IP67 immersion test acc. to EN 60529. They can therefore be used in all environments where maximum protection degree of the housing is required.

## Safety screws for actuators

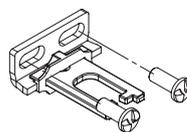

As required by EN ISO 14119, the actuator must be fixed immovably to the guard frame. Pan head safety screws with one-way fitting are available for this purpose. With this screw type, the actuators cannot be removed or tampered by using common tools. See accessories on page 332.

## Extended temperature range

# -40°C

These devices are also available in a special version suitable for an ambient operating temperature range from -40°C up to +80°C.

They can therefore be used for applications in cold stores, sterilisers and other equipment with low temperature environments. The special materials used to produce these versions retain their characteristics even under these conditions, thereby expanding the installation possibilities.

## Features approved by IMQ

Rated insulation voltage ( $U_i$ ): 500 Vac  
400 Vac (for contact blocks 20, 21, 22, 33, 34)  
Conventional free air thermal current ( $I_{th}$ ): 10 A  
Protection against short circuits: type aM fuse 10 A 500 V  
Rated impulse withstand voltage ( $U_{imp}$ ): 6 kV 4 kV (for contact blocks 20, 21, 22, 33, 34)  
Protection degree of the housing: IP67  
MV terminals (screw terminals)  
Pollution degree: 3  
Utilization category: AC15  
Operating voltage ( $U_o$ ): 400 Vac (50 Hz)  
Operating current ( $I_o$ ): 3 A  
Forms of the contact element: Zb, Y+Y, Y+Y+X, Y+Y+Y, Y+X+X  
Positive opening of contacts on contact blocks 5, 6, 7, 9, 11, 13, 14, 18, 20, 21, 22, 33, 34, 66  
In compliance with standards: EN 60947-1, EN 60947-5-1, fundamental requirements of the Low Voltage Directive 2014/35/EU.

Please contact our technical department for the list of approved products.

## Features approved by UL

Electrical Ratings: Q300 pilot duty (69 VA, 125-250 V dc)  
A600 pilot duty (720 VA, 120-600 V ac)  
Environmental Ratings: Types 1, 4X, 12, 13  
Use 60 or 75 °C copper (Cu) conductor and wire size range 12, 14 AWG, stranded or solid. The terminal tightening torque of 7.1 lb in (0.8 Nm).  
The hub is to be connected to the conduit before the hub is connected to the enclosure.

Please contact our technical department for the list of approved products.

		Technopolymer housing Without actuator		Technopolymer housing Without actuator		Technopolymer housing Without actuator		Technopolymer housing Without actuator	
Contact type: <b>R</b> = snap action <b>L</b> = slow action <b>LO</b> = slow action make before break <b>LS</b> = slow action shifted <b>LV</b> = slow action shifted and spaced <b>LA</b> = slow action close									
Contact blocks									
5	<b>R</b>	FR 593-M2	⊕ 1NO+1NC	FX 593-M2	⊕ 1NO+1NC	FW 592-M2	⊕ 1NO+1NC		/
6	<b>L</b>	FR 693-M2	⊕ 1NO+1NC	FX 693-M2	⊕ 1NO+1NC	FW 692-M2	⊕ 1NO+1NC		/
7	<b>LO</b>	FR 793-M2	⊕ 1NO+1NC	FX 793-M2	⊕ 1NO+1NC	FW 792-M2	⊕ 1NO+1NC		/
9	<b>L</b>	FR 993-M2	⊕ 2NC	FX 993-M2	⊕ 2NC	FW 992-M2	⊕ 2NC		/
11	<b>R</b>	FR 1193-M2	⊕ 2NC	FX 1193-M2	⊕ 2NC	FW 1192-M2	⊕ 2NC		/
13	<b>LV</b>	FR 1393-M2	⊕ 2NC	FX 1393-M2	⊕ 2NC	FW 1392-M2	⊕ 2NC		/
14	<b>LS</b>	FR 1493-M2	⊕ 2NC	FX 1493-M2	⊕ 2NC	FW 1492-M2	⊕ 2NC		/
18	<b>LA</b>	FR 1893-M2	⊕ 1NO+1NC	FX 1893-M2	⊕ 1NO+1NC	FW 1892-M2	⊕ 1NO+1NC		/
20	<b>L</b>	FR 2093-M2	⊕ 1NO+2NC	FX 2093-M2	⊕ 1NO+2NC	FW 2092-M2	⊕ 1NO+2NC		/
21	<b>L</b>	FR 2193-M2	⊕ 3NC	FX 2193-M2	⊕ 3NC	FW 2192-M2	⊕ 3NC		/
22	<b>L</b>	FR 2293-M2	⊕ 2NO+1NC	FX 2293-M2	⊕ 2NO+1NC	FW 2292-M2	⊕ 2NO+1NC		/
33	<b>L</b>	FR 3393-M2	⊕ 1NO+1NC	FX 3393-M2	⊕ 1NO+1NC	FW 3392-M2	⊕ 1NO+1NC	FK 3393-M1	⊕ 1NO+1NC
34	<b>L</b>	FR 3493-M2	⊕ 2NC	FX 3493-M2	⊕ 2NC	FW 3492-M2	⊕ 2NC	FK 3493-M1	⊕ 2NC
37	<b>LO</b>	FR 3793-M2	⊕ 1NO+1NC	FX 3793-M2	⊕ 1NO+1NC	FW 3792-M2	⊕ 1NO+1NC		/
66	<b>L</b>	FR 6693-M2	⊕ 1NC	FX 6693-M2	⊕ 1NC	FW 6692-M2	⊕ 1NC		/
Actuating force		10 N (18 N ⊕)		10 N (18 N ⊕)		10 N (18 N ⊕)		10 N (18 N ⊕)	
Travel diagrams		page 344 - group 8		page 344 - group 8		page 344 - group 8		page 344 - group 8	

All switches listed above are available in a version with 30 N actuator extraction force. To obtain these products, the order code must be changed by adding the extension "E3", for example FR 693-M2E3.

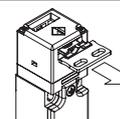

Actuator extraction force: 30 N	30 N (38 N ⊕)	30 N (38 N ⊕)	30 N (38 N ⊕)	30 N (38 N ⊕)
---------------------------------	---------------	---------------	---------------	---------------

### Limits of use

- Do not use where dust and dirt may penetrate in any way into the head and deposit there. In particular where metal dust, concrete or chemicals are spread.
- Adhere to the EN ISO 14119 requirements regarding low level of coding for interlocks.
- Do not use in environments with presence of explosive or flammable gases or dusts. In these cases use ATEX products (see dedicated Pizzato catalogue).



### Stainless steel actuators

**IMPORTANT:** These actuators can only be used with items of the FR, FX, FK and FW series (e.g. FR 693-M2).  
Low level of coding acc. to EN ISO 14119.

Article	Description
VF KEYD	Straight actuator

Article	Description
VF KEYD1	Angled actuator

Article	Description
VF KEYD2	Jointed actuator

Article	Description
VF KEYD3	Actuator adjustable in two directions

The actuator can flex in four directions for applications where the guard alignment is not precise.

Actuator adjustable in two directions for guards with reduced dimensions.

Article	Description
VF KEYD5	Extended actuator

Article	Description
VF KEYD6	Extended actuator, angled

Article	Description
VF KEYD7	Actuator adjustable in one direction

Actuator adjustable in one direction for guards with reduced dimensions.

Article	Description
VF KEYD8	Universal actuator

Jointed actuator for guards with poor alignment, adjustable in two dimensions for small doors; can be mounted in various positions. The fixing body has two pairs of bore holes; it is provided for rotating the working plane of the actuator by 90°.

Article	Description
VF KEYD10	Profiled actuator

Article	Description
VF KEYD11	Profiled actuator

All values in the drawings are in mm

Accessories See page 321

→ The 2D and 3D files are available at [www.pizzato.com](http://www.pizzato.com)

Selection diagram

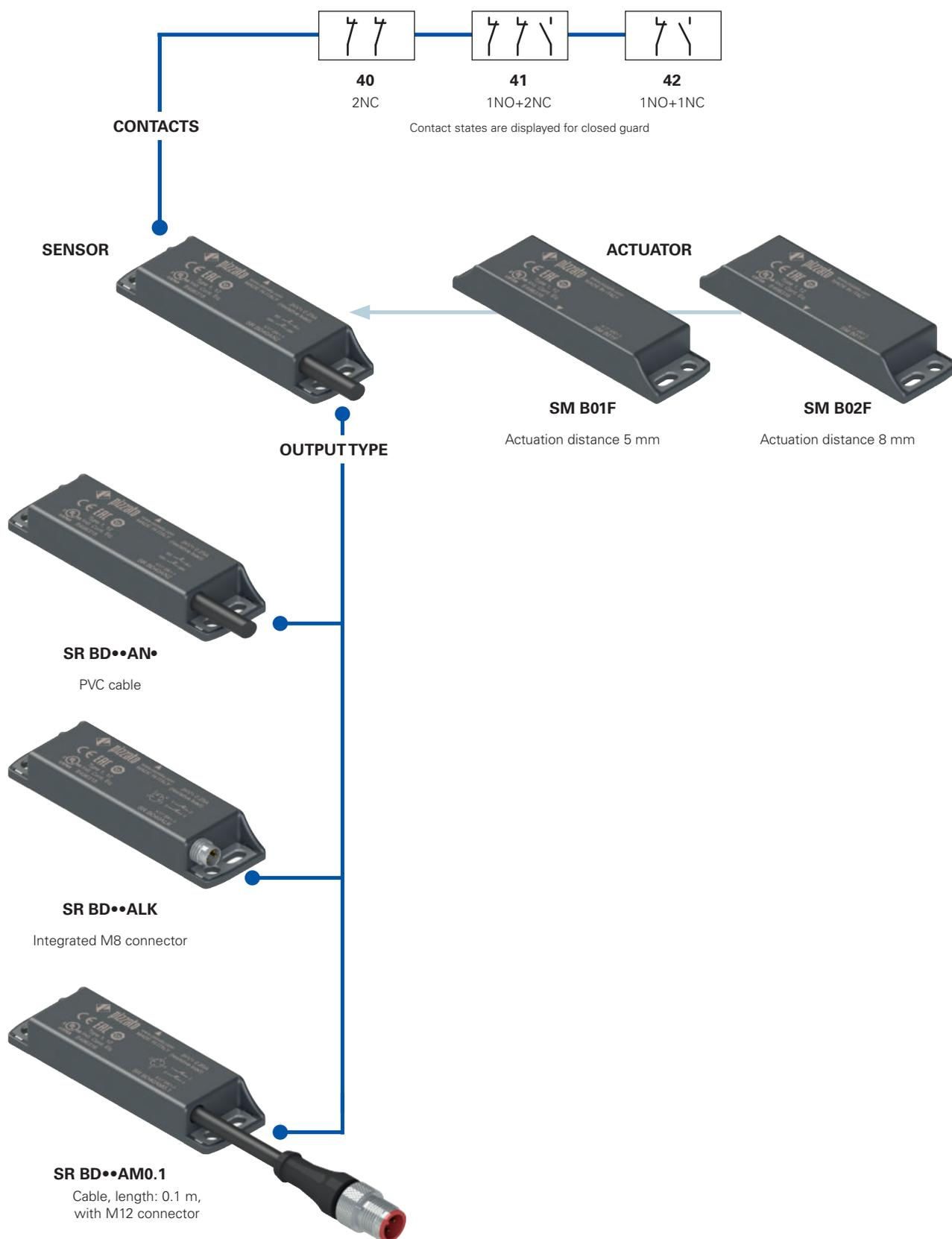

● product option  
→ sold separately as accessory



**Attention!** The feasibility of a code number does not mean the effective availability of a product. Please contact our sales office.

### Code structure for sensor with actuator

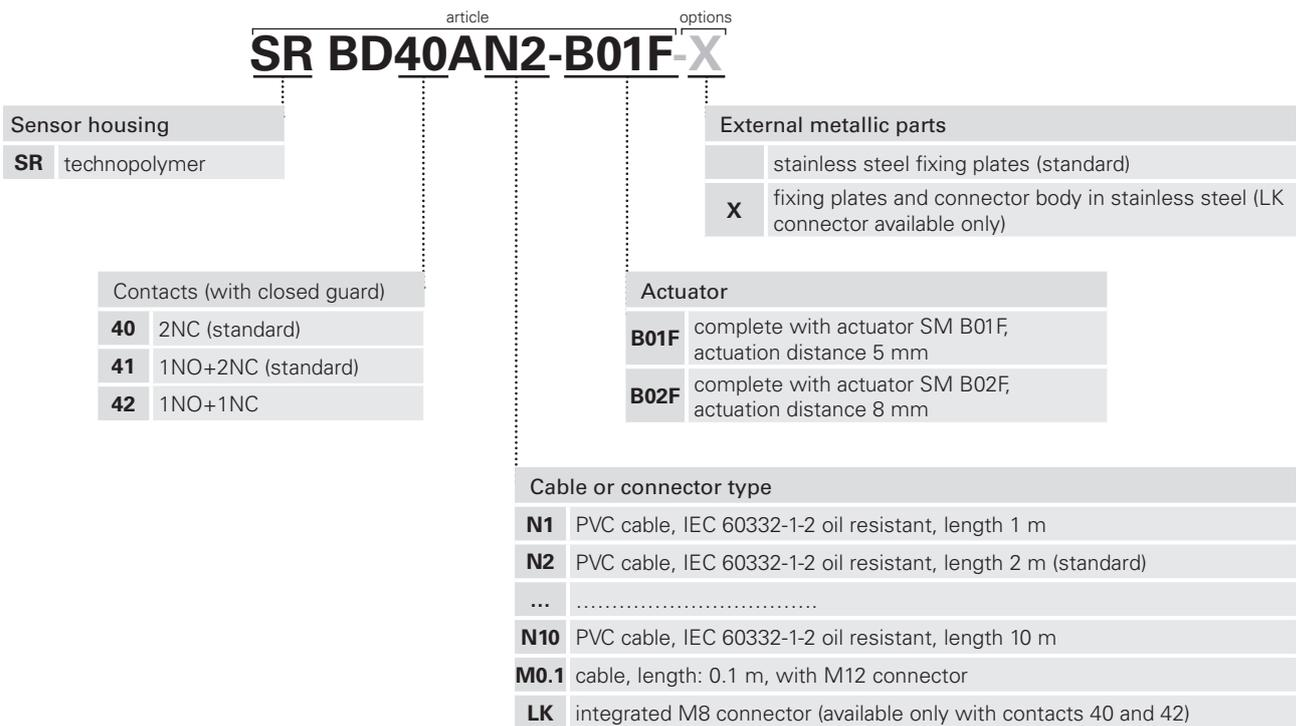

**Attention!** The feasibility of a code number does not mean the effective availability of a product. Please contact our sales office.

### Code structure for single sensor

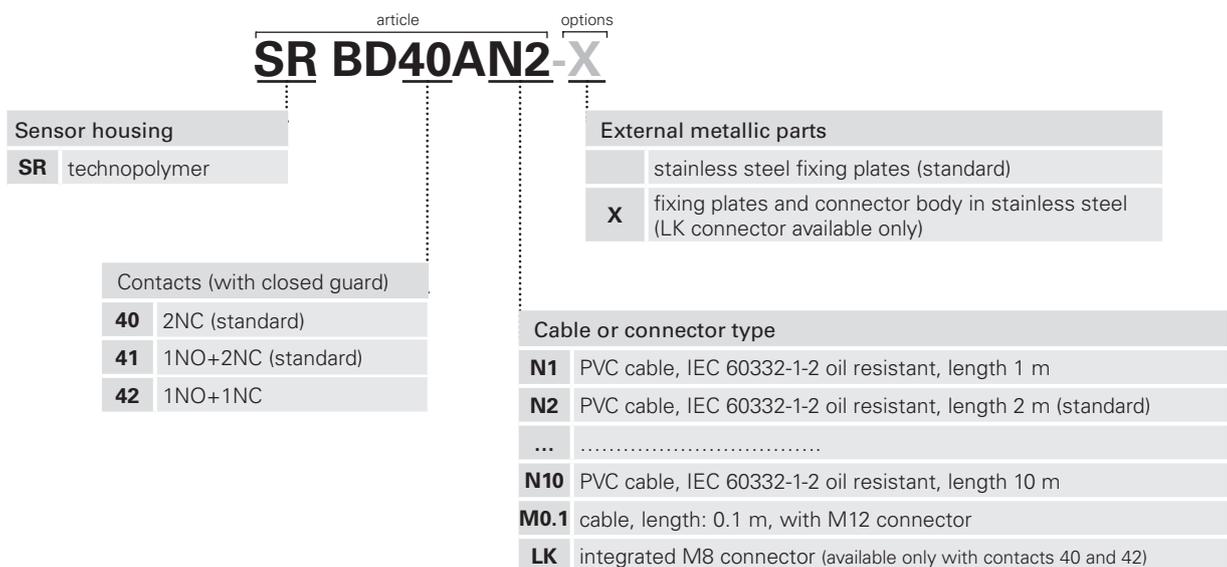

**Attention!** The feasibility of a code number does not mean the effective availability of a product. Please contact our sales office.

### Code structure for single actuator

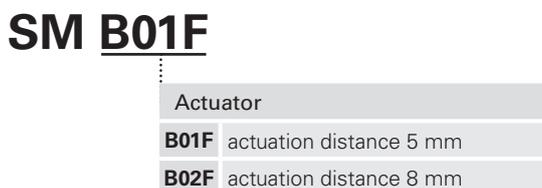



### Main features

- Actuation without mechanical contact
- Stainless steel fixing plates
- Output contacts: 2NC, 1NO+2NC or 1NO+1NC
- Insensitive to dirt
- Protection degrees IP67 and IP69K
- Coded actuator
- Technopolymer housing
- Versions with M8 or M12 connector

### Quality marks:



UL approval: E496318  
 TÜV SÜD approval: Z10 18 05 75157 024  
 EAC approval: RU C-IT.YT03.B.00035/19

### Compliance with the requirements of:

Machinery Directive 2006/42/EC,  
 EMC Directive 2014/30/EU,  
 RoHS Directive 2011/65/EU.

### Technical data

#### Housing

Housing made of glass fibre reinforced technopolymer, self-extinguishing.  
 Versions with integrated cable 4 x 0.34 mm<sup>2</sup> or 6 x 0.25 mm<sup>2</sup>, length 2 m, other lengths from 0.5 m ... 10 m on request.

Versions with integrated M8 connector

Versions with 0.1 m cable length and M12 connector, other lengths from 0.1 ... 3 m on request

Protection degree:

IP67 acc. to EN 60529

IP69K acc. to ISO 20653

(Protect the cables from direct high-pressure and high-temperature jets)

#### General data

SIL (SIL CL) up to:

SIL 3 acc. to EN 62061

Performance Level (PL) up to:

PL e acc. to EN ISO 13849-1

Safety category up to:

cat. 4 acc. to EN ISO 13849-1

Interlock, no contact, coded:

type 4 acc. to EN ISO 14119

Coding level:

low acc. to EN ISO 14119

Safety parameter B<sub>10D</sub>:

20,000,000 (with compatible Pizzato Elettrica safety modules)

400,000 (at max. load: DC12 24 V 250 mA)

Mission time:

20 years

Ambient temperature:

-25°C ... +80°C

Ambient temp. with flexible installation cable:

-5°C ... +80°C

Vibration resistance:

10 gn (10 ... 150 Hz) acc. to IEC 60068-2-6

Shock resistance:

30 gn; 11 ms acc. to EN 60068-2-27

Pollution degree

3

Screw tightening torque:

0.8 ... 2 Nm

#### In compliance with standards:

IEC 60947-1, IEC 60947-5-1, IEC 60947-5-2, IEC 60947-5-3 (in connection with safety module), EN ISO 14119, EN ISO 12100, EN ISO 13849-1, EN ISO 13849-2, IEC 62061:2005, IEC 60204-1, IEC 60529, IEC 61508-1, IEC 61508-2, IEC 61508-4, EN 50581, ISO 20653, UL 508, CSA 22.2 No.14.

#### Approvals:

UL 508, CSA 22.2 No.14, EN ISO 13849-1, EN 60947-5-3, EN 50178, EN 61508-1, EN 61508-2, EN 61508-4, EN 62061, EN 60947-1.

#### Actuation data

Assured operating distance S<sub>ao</sub>:

5 mm with actuator SM B01F

8 mm with actuator SM B02F

Assured release distance S<sub>ar</sub>:

15 mm with actuator SM B01F

20 mm with actuator SM B02F

Repeat accuracy:

≤ 10%

Switching frequency:

up to 1 Hz

Distance between two sensors:

min. 50 mm

#### Electrical data

Rated operating voltage U<sub>e</sub>:

24 Vac/dc

Rated operating current I<sub>e</sub>:

0.25 A (resistive load)

Rated insulation voltage U<sub>i</sub>:

120 Vac (with cable)

60 Vac / 75 Vdc (with M8 connector)

120 Vac (with M12 connector, 4-pole)

30 Vac / 36 Vdc (with M12 connector, 8-pole)

Rated impulse withstand voltage (U<sub>imp</sub>):

6 kV

1.5 kV (with connector)

Thermal current I<sub>th</sub>:

0.25 A

Maximum switching load:

6 W (resistive load)

Protection fuse:

0.25 A type F

Electrical endurance:

1 million operating cycles

**⚠ If not expressly indicated in this chapter, for correct installation and utilization of all articles see the instructions given on pages 337 to 350.**

### Connection with safety modules for safety applications:

Connection with safety modules CS AR-01••••; CS AR-02••••; CS AR-04••••; CS AR-05••••; CS AR-06••••; CS AR-08••••; CS AR-46•024; CS AR-91••••; CS AT-0••••; CS AT-1••••; CS AT-3••••; CS FS-5••••; CS MF••••••; CS MP••••••.

When connected to the safety module, the sensor can be classified as a control circuit device up to PDF-M (EN 60947-5-3).

The system can be used in safety circuits up to PL e/SIL 3/category 4 in accordance with EN ISO 13849-1.

### Features approved by UL

Electrical Ratings: 24 Vdc, 0,25 A (resistive load)

Environmental Ratings: Types 1, 4X, 6, 12, 13

Accessory for series SR for actuator switch series SM B.

### Features approved by TÜV SÜD

Supply voltage: 24 Vac/dc

Rated operating current (max.): 0.25 A

Ambient temperature: -25°C ... +80°C

Protection degree: IP67

PL, category: PL e, cat. 4. with CS AR-08

In compliance with standards: 2006/42/EC Machinery Directive, EN ISO 13849-1:2015 (Cat. 4, PL e), EN 60947-5-3:2013, EN ISO 14119:2013, EN 61508-1:2010 (SIL 3), EN 61508-2:2010 (SIL 3), EN 61508-4:2010 (SIL 3), EN 62061:2005/A2:2015 (SIL CL 3)

Please contact our technical department for the list of approved products.

Please contact our technical department for the list of approved products.

## Description



Coded magnetic sensors are devices suitable for monitoring protections and guards of machines without inertia which, when linked to a safety module, can create a system with safety category up to SIL 3 according to EN 62061, up to PL e according to EN ISO 13849-1 and up to category 4 according to EN ISO 13849-1.

These products consist of a sensor that detects the magnetic field and which is connected to the machine structure and of a coded magnetic actuator, which is connected to the movable guard. When the sensor and actuator are approached (closed guard), the sensor detects the actuator and actuates the electrical contacts. The sensor is designed to be activated only by the correct coded actuator and not through a common magnet.

## Insensitivity to dirt

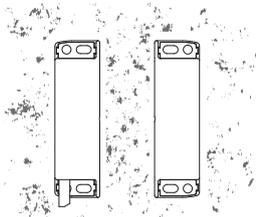

Magnetic sensors are totally sealed and retain their safety characteristics also where dirt and dust are present (not ferromagnetic material). This characteristic, combined with the design without recesses, makes them particularly suitable for use in the food industry.

## Wide actuation range

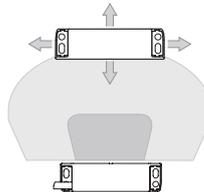

With their built-in features, magnetic sensors have a wide actuation range, making them very well suited for applications with large tolerances or where mechanical properties change over time.

In this type of sensor, the actuation distances may vary depending on the shift direction of the actuator in relation to the sensor.

## Actuation from many directions

The coded magnetic sensors were designed to be activated by the respective actuator from various directions. The customer therefore enjoys maximum flexibility when positioning devices along the perimeter of the guards.

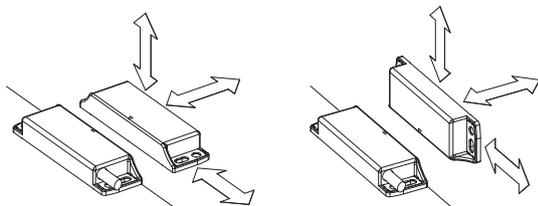

## Stainless steel fixing plates

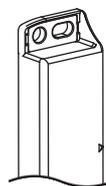

To prevent damage to the fixing slots when fastening on non-perfectly flat surfaces, coded magnetic sensors are equipped with stainless steel fixing plates. Even in the presence of suitable fixing surfaces, this solution makes the sensor more robust against mechanical stresses.

## Assembly of multiple sensor-actuator systems

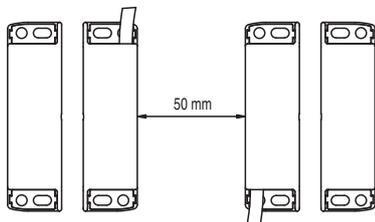

It is possible to install more than one device on the same machine. The minimum mounting distance between sensor-actuator systems is only 50 mm.

## Safety screws for actuators

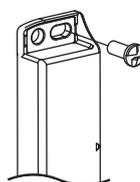

As required by EN ISO 14119, the actuator must be fixed immovably to the door frame. Pan head safety screws with one-way fitting are available for this purpose. With this screw type, the actuators cannot be removed or tampered by using common tools.

See accessories on page 332.

## Laser engraving



All devices are marked using a dedicated indelible laser system. These engravings are therefore suitable for extreme environments too. Thanks to this system that does not use labels, the loss of plate data is prevented and a greater resistance of the marking is achieved over time.

## Series connection of multiple sensors

The coded magnetic sensors can be connected in series with the only limitation that the overall resistance, of sensors and the related wiring, has to be not higher than the admitted max. value of the module, which typically is equal to 50 ohm (see module features). This is a very high value that, with normal wiring, allows the use of dozens of sensors without problems. It is also possible to realise mixed circuit solutions by connecting coded magnetic sensors in series to safety switches, with the only limitation being the above-mentioned maximum electrical resistance.

It should be noted that the series connection of two or more coded sensors reduces the self-monitoring capacity of the system, see ISO/TR 24119.

The use of Pizzato Elettrica safety modules is recommended.

## Protection degrees IP67 and IP69K

**IP69K**  
**IP67**

These devices are designed to be used in the toughest environmental conditions and they pass the IP67 immersion test acc. to EN 60529. They can therefore be used in all environments where maximum protection degree of the housing is required. Due to their special design, these devices are suitable for use in equipment subjected to cleaning with high pressure hot water jets. These devices meet the IP69K test requirements according to ISO 20653 (water jets with 100 bar and 80°C).

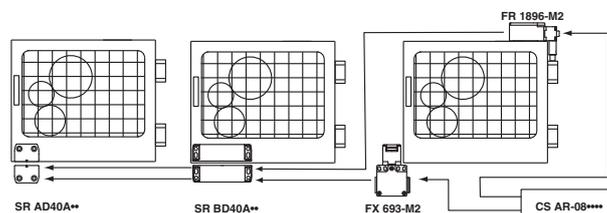

## Internal connections with cable

Contact states are displayed for closed guard

With cable (2NC)

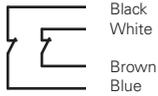

Black  
White  
  
Brown  
Blue

With cable (1NO+1NC)

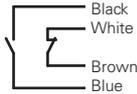

Black  
White  
  
Brown  
Blue

With cable (1NO+2NC)



Green  
Brown  
Grey  
  
Pink  
White  
Yellow

## Internal connections with connector

Contact states are displayed for closed guard

With M12 connector (1NO+2NC)

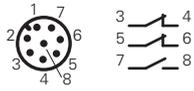

With M12 connector (2NC)

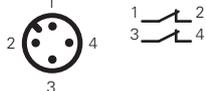

With M12 connector (1NO+1NC)

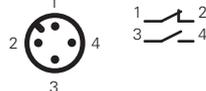

With M8 connector (2NC)

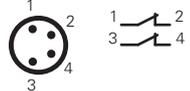

With M8 connector (1NO+1NC)

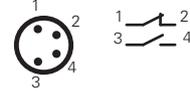

For female connectors, see page 321

## Connection with safety modules

A coded magnetic sensor alone cannot be used for safety functions because its operating principles are not considered safe by the standards (e.g. positive opening on mechanical switches). For this reason, a magnetic sensor coded for use in safety applications must always be connected to a safety module that monitors its proper operation through a circuit with at least two channels.

## Compatible safety modules

These magnetic sensors have been checked and tested for operation with suitable safety modules (see list).

The use of complete and tested solutions guarantees the electrical compatibility between the sensor and safety module, as well as high reliability.

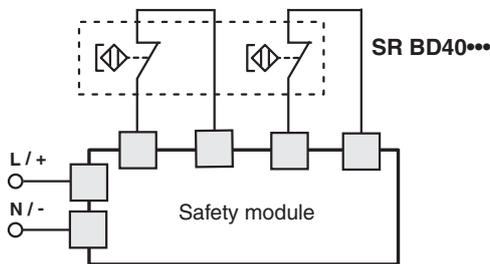

Sensors	Compatible safety modules	Safety module output contacts	
		Instantaneous contacts	Delayed contacts
SR BD40A... SR BD41A... SR BD42A... <sup>a</sup>	CS AR-01•••• <sup>b</sup>	2NO+1NC	/
	CS AR-02•••• <sup>b</sup>	3NO	/
	CS AR-04•••• <sup>b</sup>	3NO+1NC	/
	CS AR-05••••	3NO+1NC	/
	CS AR-06••••	3NO+1NC	/
	CS AR-08••••	2NO	/
	CS AR-46•024	1NO	/
	CS AR-91••••	2NO+1PNP	/
	CS AR-94••••	2NO	/
	CS AR-95••••	2NO	/
	CS AT-0•••••	2NO+1NO	2NO
	CS AT-1•••••	3NO	2NO
	CS AT-3•••••	2NO	1NO
	CS FS-5•••••	1NO+1NC+1CO	/
	CS MP••••••••	see page 277	see page 277
	CS MF••••••••	see page 305	see page 305

<sup>a</sup> Compatible with CS MF202••-P4 and CS MP•••••••• only.

<sup>b</sup> Compatible with modules with production batch later than 06/2014 only. For features of the safety modules see page 213.

### Connection with safety modules CS AR-05 or CS AR-06

Input configuration with manual start (CS AR-05) and monitored start (CS AR-06)

2 channels

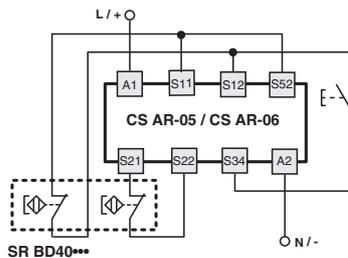

### Connection with safety modules CS AR-08 or CS AT

Input configuration with manual start

2 channels

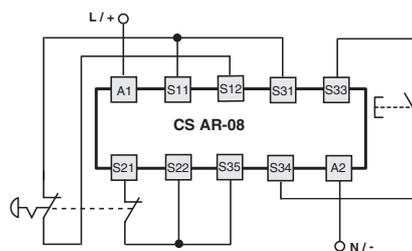

For features of the safety modules see page 213.





**Operating distances SR BD.....-B01F**

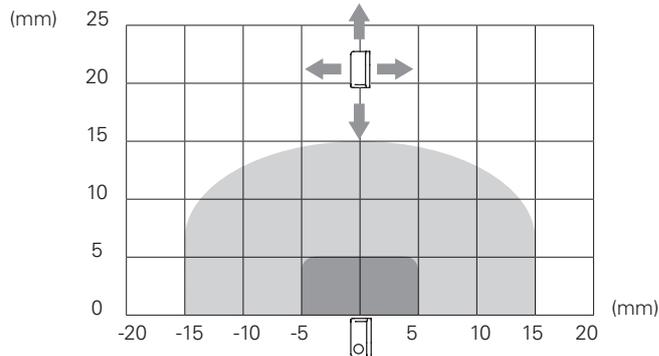
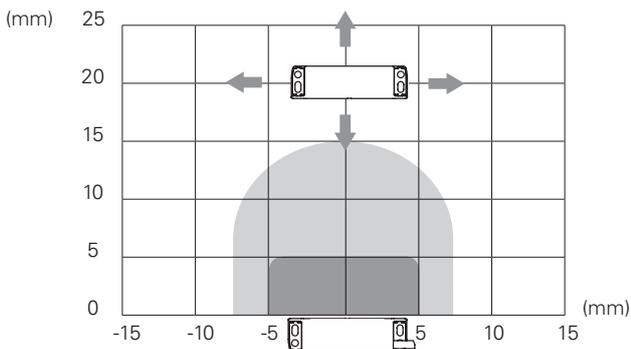

**Operating distances SR BD.....-B02F**

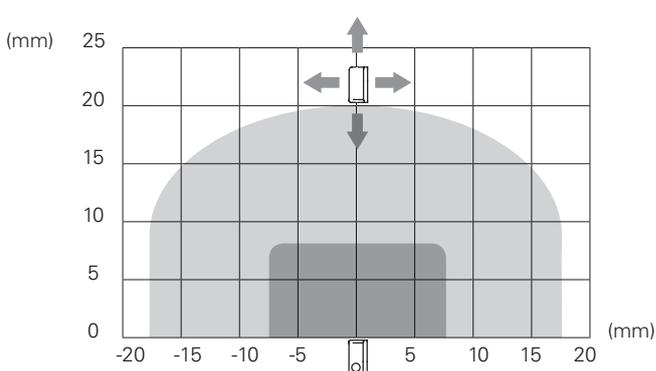
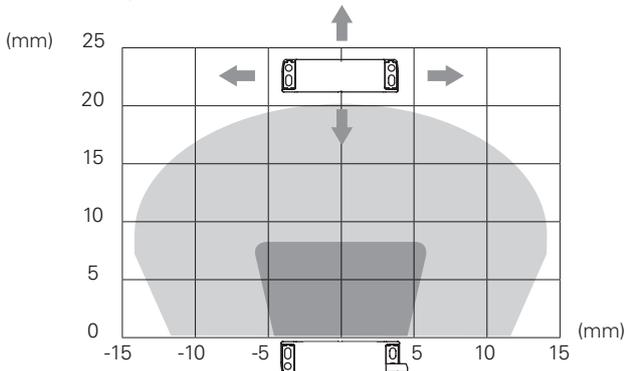

Legend:  
 Assured operating distance  $S_{ao}$      Assured release distance  $S_{ar}$   
 Note: The progress of the activation areas is for reference only

**Dimensional drawings**

Integrated cable, length: 2 m		M8 connector		Cable, length: 0.1 m, with M12 connector		coded actuator Low level of coding acc. to EN ISO 14119	
SR BD40AN2	2NC	SR BD40ALK	2NC	SR BD40AM0.1	2NC	SM B01F	Actuation distance 5 mm
SR BD41AN2	1NO+2NC	/	/	SR BD41AM0.1	1NO+2NC	SM B02F	Actuation distance 8 mm
SR BD42AN2	1NO+1NC	SR BD42ALK	1NO+1NC	SR BD42AM0.1	1NO+1NC		

**Accessories**

**Spacer**

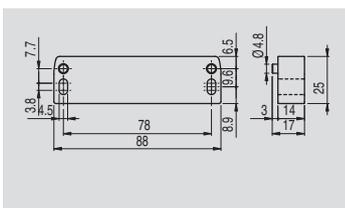

If possible do not mount the sensor and the actuator on ferromagnetic materials.  
 This spacer is placed between the magnetic safety sensors and metal surfaces that can deflect the magnetic field: as a result, the activation and deactivation distances of the sensor remain the same.  
 Because it is made out of a single block of material, it is especially well suited for applications where a high level of cleanliness is required, as any material present in the installation area cannot penetrate and accumulate.

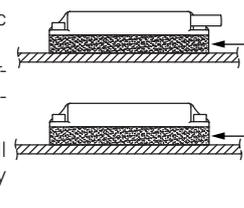

Spacer

Article	Description
VS SP1BA1	Spacer for SR B series sensors

All values in the drawings are in mm

Accessories See page 321

→ The 2D and 3D files are available at [www.pizzato.com](http://www.pizzato.com)

Selection diagram

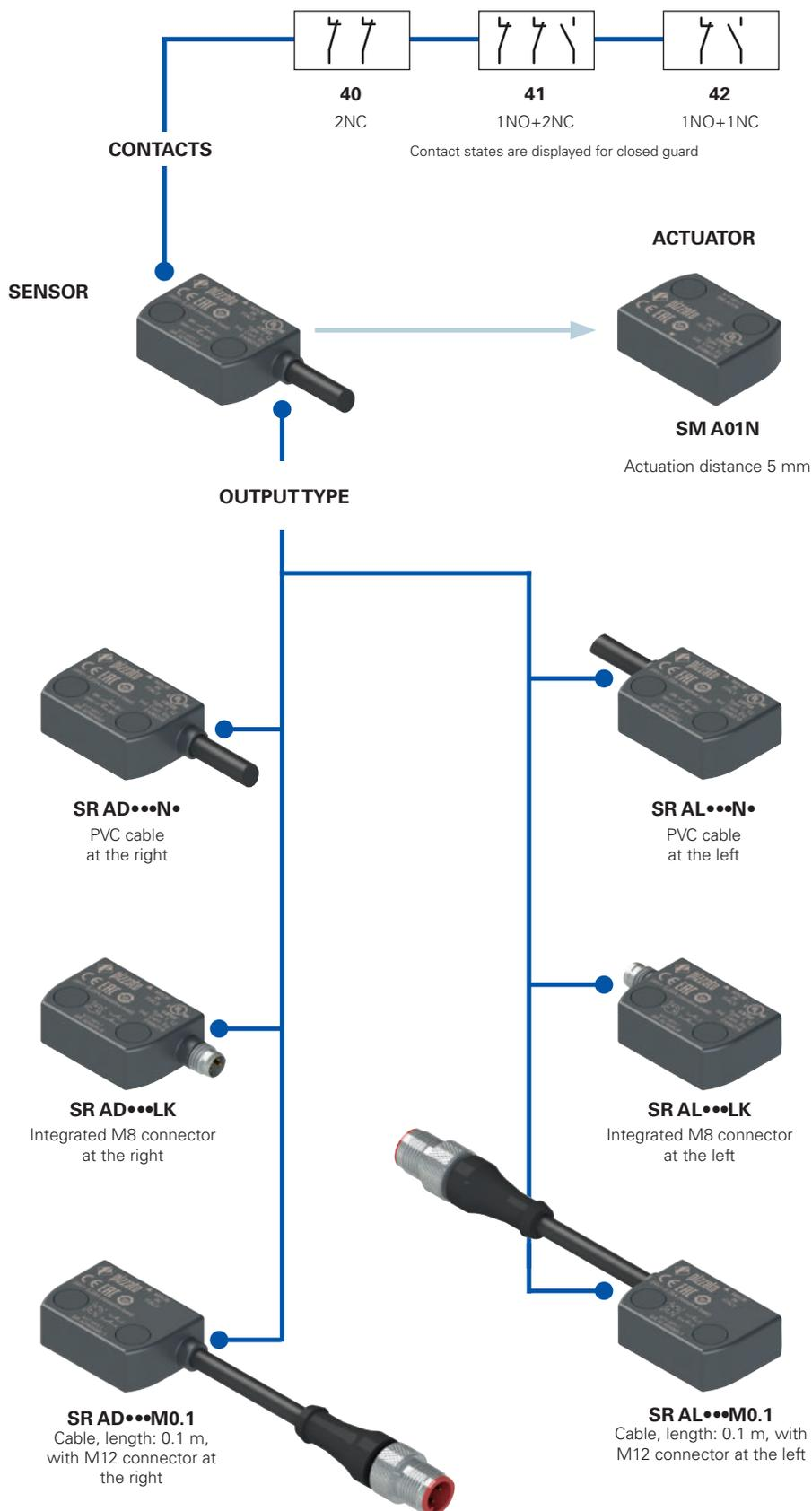

● product option  
→ sold separately as accessory



**Attention!** The feasibility of a code number does not mean the effective availability of a product. Please contact our sales office.

### Code structure for sensor with actuator

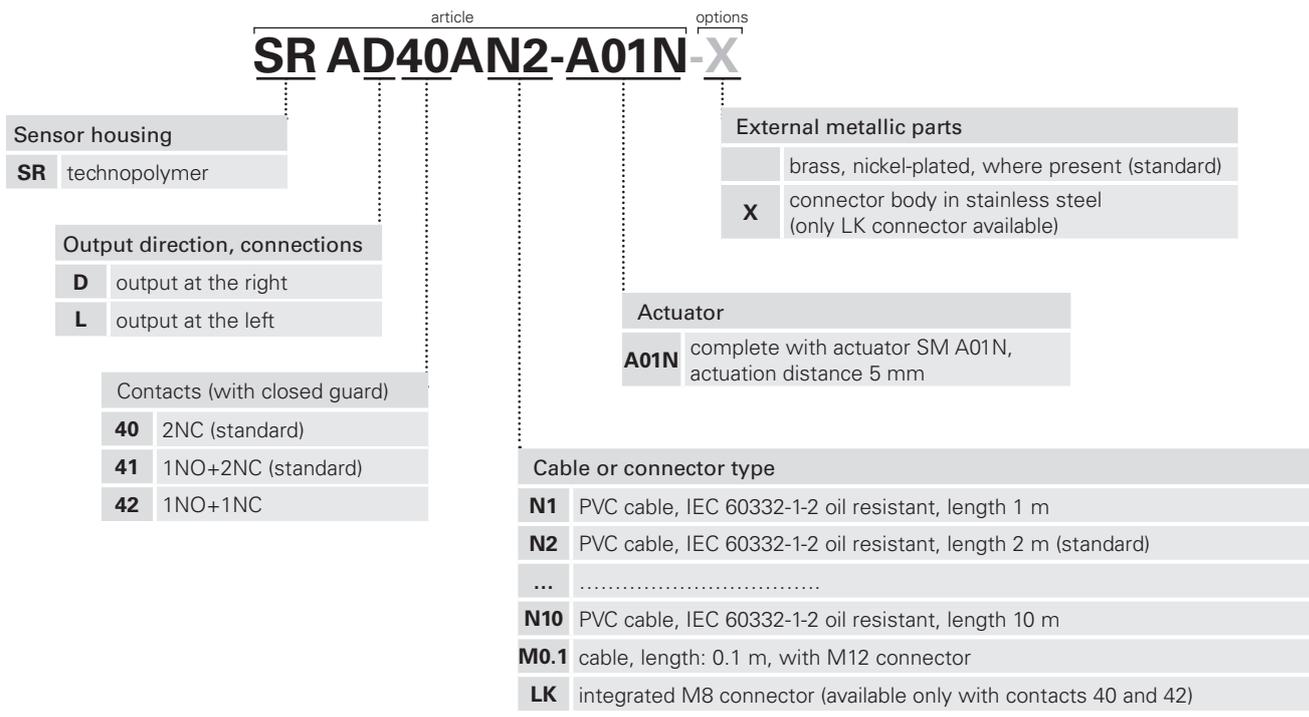

**Attention!** The feasibility of a code number does not mean the effective availability of a product. Please contact our sales office.

### Code structure for single sensor

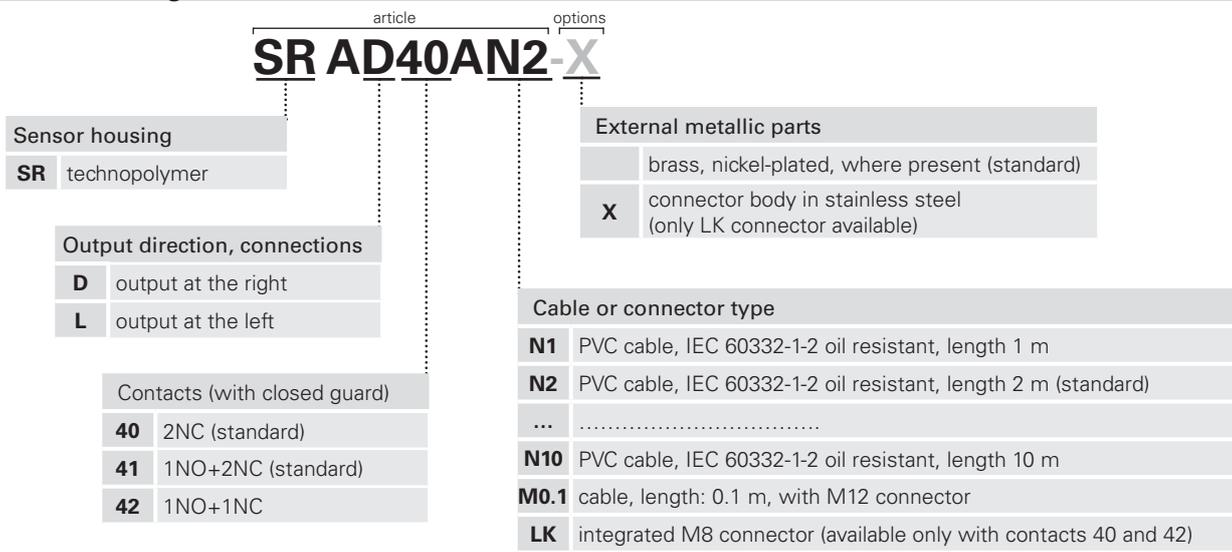

**Attention!** The feasibility of a code number does not mean the effective availability of a product. Please contact our sales office.

### Code structure for single actuator

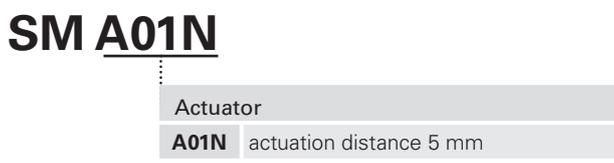



### Main features

- Actuation without mechanical contact
- Output contacts: 2NC, 1NO+2NC or 1NO+1NC
- Insensitive to dirt
- Protection degrees IP67 and IP69K
- Coded actuator
- Technopolymer housing
- Versions with M8 or M12 connector

### Quality marks:



UL approval: E496318  
 TÜV SÜD approval: Z10 18 05 75157 024  
 EAC approval: RU C-IT.VT03.B.00035/19

### Compliance with the requirements of:

Machinery Directive 2006/42/EC,  
 EMC Directive 2014/30/EU,  
 RoHS Directive 2011/65/EU.

### Technical data

#### Housing

Housing made of glass fibre reinforced technopolymer, self-extinguishing.  
 Versions with integrated cable 4 x 0.34 mm<sup>2</sup> or 6 x 0.25 mm<sup>2</sup>, length 2 m, other lengths from 0.5 m ... 10 m on request.  
 Versions with integrated M8 connector.  
 Versions with 0.1 m cable length and M12 connector, other lengths from 0.1 ... 3 m on request

Protection degree: IP67 acc. to EN 60529  
 IP69K acc. to ISO 20653  
 (Protect the cables from direct high-pressure and high-temperature jets)

#### General data

SIL (SIL CL) up to: SIL 3 acc. to EN 62061  
 Performance Level (PL) up to: PL e acc. to EN ISO 13849-1  
 Safety category up to: cat. 4 acc. to EN ISO 13849-1  
 Interlock, no contact, coded: type 4 acc. to EN ISO 14119  
 Coding level: low acc. to EN ISO 14119  
 Safety parameter B<sub>10d</sub>: 20,000,000 (used with Pizzato safety modules)

400,000  
 (used with max load: DC12 24 V 0.25 A)  
 20 years  
 Ambient temperature: -25°C ... +80°C  
 Ambient temperature with flexible installation cable: -5°C ... +80°C  
 Vibration resistance: 10 gn (10 ... 150 Hz) acc. to IEC 60068-2-6  
 30 gn; 11 ms acc. to EN 60068-2-27  
 Shock resistance: 3  
 Pollution degree: 0.8 ... 2 Nm

#### In compliance with standards:

IEC 60947-1:2007, IEC 60947-5-1, IEC 60947-5-2, IEC 60947-5-3 (in connection with safety module), EN ISO 14119, EN ISO 12100, EN ISO 13849-1, EN ISO 13849-2, IEC 62061, IEC 60204-1, IEC 60529, IEC 61508-1, EN 61508-2:2010, IEC 61508-4, EN 50581, ISO 20653, UL 508, CSA 22.2 No.14

#### Approvals:

UL 508, CSA 22.2 No.14, EN ISO 13849-1, EN 60947-5-3, EN 50178, EN 61508-1, EN 61508-2, EN 61508-4, EN 62061, EN 60947-1.

#### Actuation data

Assured operating distance S<sub>ao</sub>: 5 mm with actuator SM A01N  
 Assured release distance S<sub>ar</sub>: 15 mm with actuator SM A01N  
 Repeat accuracy: ≤ 10%  
 Switching frequency: up to 1 Hz  
 Distance between two sensors: minimum 50 mm

#### Electrical data

Rated operating voltage U<sub>e</sub>: 24 Vac/dc  
 Rated operating current I<sub>e</sub>: 0.25 A (resistive load)  
 Rated insulation voltage U<sub>i</sub>: 120 Vac (with cable)  
 60 Vac / 75 Vdc (with M8 connector)  
 120 Vac (with M12 connector, 4-pole)  
 30 Vac / 36 Vdc (with M12 connector, 8-pole)  
 Rated impulse withstand voltage (U<sub>imp</sub>): 6 kV / 1.5 kV (with connector)  
 Thermal current I<sub>th</sub>: 0.25 A  
 Maximum switching load: 6 W (resistive load)  
 Protection fuse: 0.25 A type F  
 Electrical endurance: 1 million operating cycles

**⚠ If not expressly indicated in this chapter, for correct installation and utilization of all articles see the instructions given on pages 337 to 350.**

### Connection with safety modules for safety applications:

Connection with safety modules CS AR-01●●●●; CS AR-02●●●●; CS AR-04●●●●; CS AR-05●●●●; CS AR-06●●●●; CS AR-08●●●●; CS AR-46●024; CS AR-91●●●●; CS AT-0●●●●; CS AT-1●●●●; CS AT-3●●●●; CS FS-5●●●●; CS MF●●●●●●; CS MP●●●●●●.

When connected to the safety module, the sensor can be classified as a control circuit device up to PDF-M (EN 60947-5-3).

The system can be used in safety circuits up to PL e/SIL 3/category 4 in accordance with EN ISO 13849-1.

### Features approved by UL

Electrical Ratings: 24 Vdc, 0,25 A (resistive load)  
 Environmental Ratings: Types 1, 4X, 6, 12, 13  
 Accessory for series SR for actuator switch series SM A.

### Features approved by TÜV SÜD

Supply voltage: 24 Vac/dc  
 Rated operating current (max.): 0.25 A  
 Ambient temperature: -25°C ... +80°C  
 Protection degree: IP67  
 PL, category: PL e, cat. 4. with CS AR-08

In compliance with standards: 2006/42/EC Machinery Directive, EN ISO 13849-1:2015 (Cat. 4, PL e), EN 60947-5-3:2013, EN ISO 14119:2013, EN 61508-1:2010 (SIL 3), EN 61508-2:2010 (SIL 3), EN 61508-4:2010 (SIL 3), EN 62061:2005/A2:2015 (SIL CL 3)

Please contact our technical department for the list of approved products.

Please contact our technical department for the list of approved products.

## Description



Coded magnetic sensors are devices suitable for monitoring protections and guards of machines without inertia which, when linked to a safety module, can create a system with safety category up to SIL 3 according to EN 62061, up to PL e according to EN ISO 13849-1 and up to category 4 according to EN ISO 13849-1. These products consist of a sensor that detects the magnetic field and which is connected to the machine structure and of a coded magnetic actuator, which is connected to the movable guard. When the sensor and actuator are approached (closed guard), the sensor detects the actuator and actuates the electrical contacts. The sensor is designed to be activated only by the correct coded actuator and not through a common magnet.

## Insensitivity to dirt

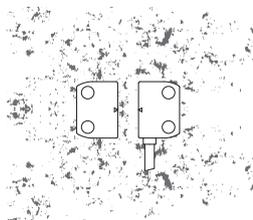

Magnetic sensors are totally sealed and retain their safety characteristics also where dirt and dust are present (not ferromagnetic material).

This characteristic, combined with the design without recesses, makes them particularly suitable for use in the food industry.

## Wide actuation range

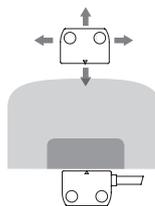

With their built-in features, magnetic sensors have a wide actuation range, making them very well suited for applications with large tolerances or where mechanical properties change over time.

In this type of sensor, the actuation distances may vary depending on the shift direction of the actuator in relation to the sensor.

## Protection against tampering

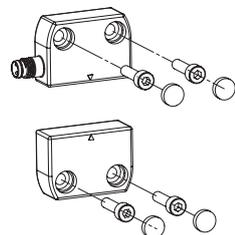

Each sensor and actuator of the SR A series is supplied complete with snap-on protection caps to be applied on the holes of the fixing screws. Not only do the caps prevent dirt from accumulating and simplify cleaning, they also block access to the fastening screws of the actuator. As a result, standard screws can be used instead of tamper-proof screws.

## Actuation from many directions

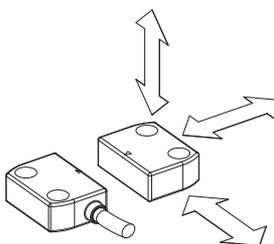

The coded magnetic sensors were designed to be activated by the respective actuator from various directions.

The customer therefore enjoys maximum flexibility when positioning devices along the perimeter of the guards.

## Laser engraving

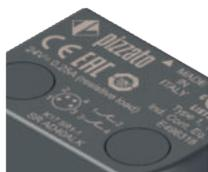

All devices are marked using a dedicated indelible laser system. These engravings are therefore suitable for extreme environments too. Thanks to this system that does not use labels, the loss of plate data is prevented and a greater resistance of the marking is achieved over time.

## Assembly of multiple sensor-actuator systems

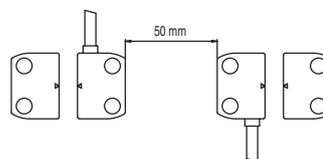

It is possible to install more than one device on the same machine. The minimum mounting distance between sensor-actuator systems is only 50 mm.

## Protection degrees IP67 and IP69K

**IP69K**  
**IP67**

These devices are designed to be used in the toughest environmental conditions and they pass the IP67 immersion test acc. to EN 60529. They can therefore be used in all environments where maximum protection degree of the housing is required. Due to

their special design, these devices are suitable for use in equipment subjected to cleaning with high pressure hot water jets. These devices meet the IP69K test requirements according to ISO 20653 (water jets with 100 bar and 80°C).

## Series connection of multiple sensors

The coded magnetic sensors can be connected in series with the only limitation that the overall resistance, of sensors and the related wiring, has to be not higher than the admitted max. value of the module, which typically is equal to 50 Ω (see module features). This is a very high value that, with normal wiring, allows the use of dozens of sensors without problems. It is also possible to realise mixed circuit solutions by connecting coded magnetic sensors in series to safety switches, with the only limitation being the above-mentioned maximum electrical resistance.

It should be noted that the series connection of two or more coded sensors reduces the self-monitoring capacity of the system, see ISO/TR 24119. The use of Pizzato Elettrica safety modules is recommended.

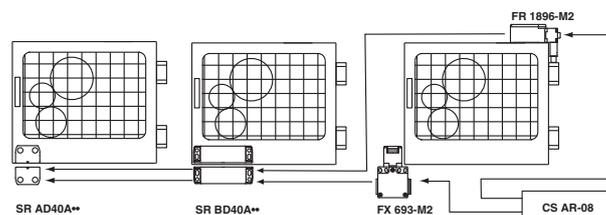

## Internal connections with cable

Contact states are displayed for closed guard

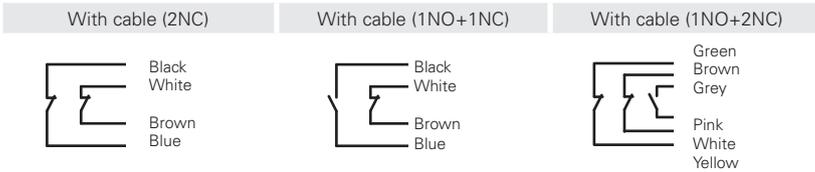

## Internal connections with connector

Contact states are displayed for closed guard

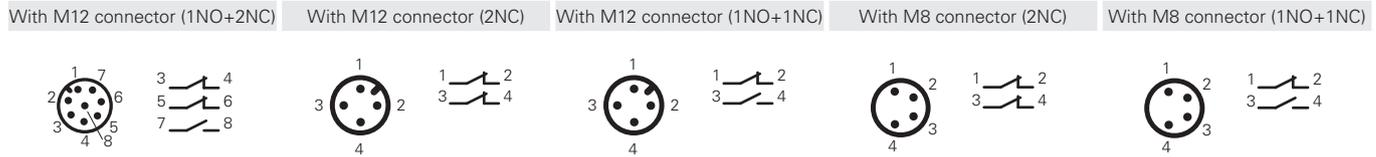

For female connectors, see page 321

## Connection with safety modules

A coded magnetic sensor alone cannot be used for safety functions because its operating principles are not considered safe by the standards (e.g. the positive opening on mechanical switches).

For this reason, a magnetic sensor coded for use in safety applications must always be connected to a safety module with at least two channels that monitors the proper function.

## Compatible safety modules

These magnetic sensors have been checked and tested for operation with suitable safety modules (see list).

The use of complete and tested solutions guarantees the electrical compatibility between the sensor and safety module, as well as high reliability.

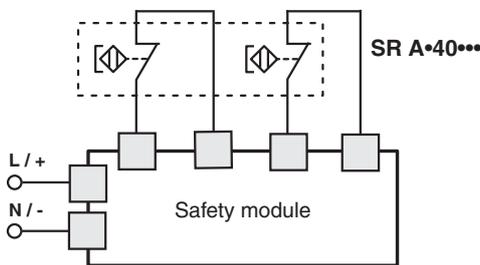

Sensors	Compatible safety modules	Safety module output contacts	
		Instantaneous contacts	Delayed contacts
SR AD40A●● SR AD41A●● SR AD42A●● <sup>a</sup>	CS AR-01●●●● <sup>b</sup>	2NO+1NC	/
	CS AR-02●●●● <sup>b</sup>	3NO	/
	CS AR-04●●●● <sup>b</sup>	3NO+1NC	/
	CS AR-05●●●●	3NO+1NC	/
	CS AR-06●●●●	3NO+1NC	/
	CS AR-08●●●●	2NO	/
	CS AR-46●024	1NO	/
	CS AR-91●●●●	2NO+1PNP	/
	CS AR-94●●●●	2NO	/
	CS AR-95●●●●	2NO	/
	CS AT-0●●●●●	2NO+1NO	2NO
	CS AT-1●●●●●	3NO	2NO
	CS AT-3●●●●●	2NO	1NO
	CS FS-5●●●●●	1NO+1NC+1CO	/
	CS MP●●●●●●●●	see page 277	see page 277
	CS MF●●●●●●●●	see page 305	see page 305

<sup>a</sup> Compatible with CS MF202●●-P4 and CS MP●●●●●●●● only.

<sup>b</sup> Compatible with modules with production batch later than 06/2014 only. For features of the safety modules see page 213.

### Connection with safety modules CS AR-05 or CS AR-06

Input configuration with manual start (CS AR-05) and monitored start (CS AR-06)

2 channels

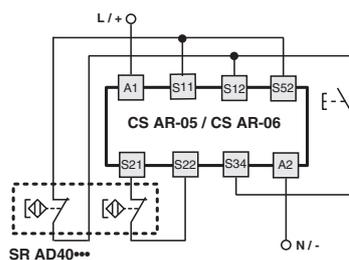

### Connection with safety modules CS AR-08 or CS AT

Input configuration with manual start

2 channels

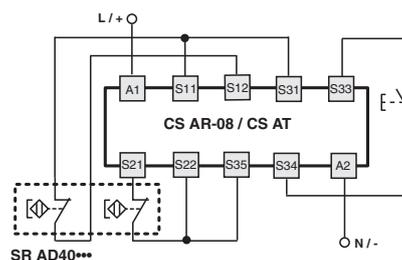

For features of the safety modules see page 213.



### Operating distances SR AD.....-A01N

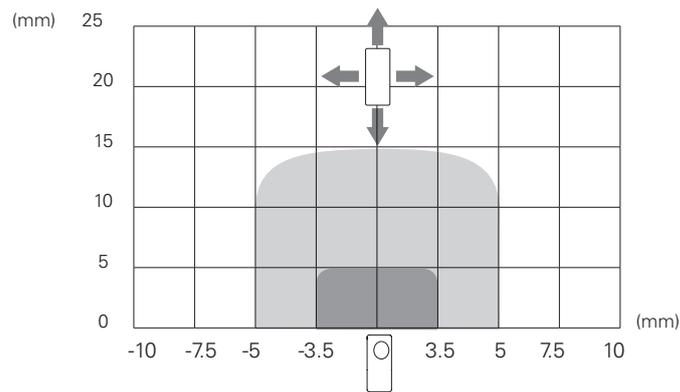
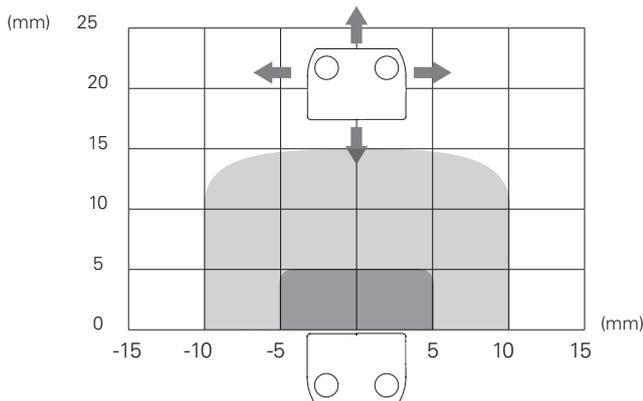

Legend:

■ Assured operating distance  $S_{ao}$

■ Assured release distance  $S_{ar}$

Note: The progress of the activation areas is for reference only

### Dimensional drawings

Integrated cable, length: 2 m, at the right		Integrated cable, length: 2 m, at the left	
SR AD40AN2	2NC	SR AL40AN2	2NC
SR AD41AN2	1NO+2NC	SR AL41AN2	1NO+2NC
SR AD42AN2	1NO+1NC	SR AL42AN2	1NO+1NC

coded actuator Low level of coding acc. to EN ISO 14119	
SM A01N	Actuation distance 5 mm

M8 connector, at the right	M8 connector, at the left	Cable, length: 0.1 m, with M12 connector at the right	Cable, length: 0.1 m, with M12 connector at the left
SR AD40ALK	2NC	SR AD40AM0.1	2NC
/	/	SR AD41AM0.1	1NO+2NC
SR AD42ALK	1NO+1NC	SR AD42AM0.1	1NO+1NC
		SR AL40AM0.1	2NC
		SR AL41AM0.1	1NO+2NC
		SR AL42AM0.1	1NO+1NC

### Accessories

#### Spacer

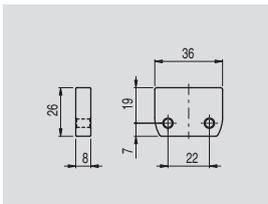

If possible do not mount the sensor and the actuator on ferromagnetic materials. This spacer is placed between the magnetic safety sensors and metal surfaces that can deflect the magnetic field: as a result, the activation and deactivation distances of the sensor remain the same. Because it is made out of a single block of material, it is especially well suited for applications where a high level of cleanliness is required, as any material present in the installation area cannot penetrate and accumulate.

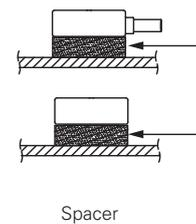

Article	Description
VS SP1AA1	Spacer for SR A series sensors

## Introduction



In combination with the corresponding safety modules, the sensors of the ST series are suitable for the monitoring of protective devices on machines without inertia and allow the system in which they are used to reach a safety category up to SIL 3 acc. to EN 62061 as well as up to PL e and Category 4 acc. to EN ISO 13849-1.

These sensors use RFID (Radio Frequency IDentification) technology and provide high protection against possible manipulation thanks to the uniqueness of the codes transmitted by the actuator. Because they have no mechanical elements, they guarantee a long service life even in applications with frequent operating cycles and under harsh environmental conditions.

## Maximum safety with a single device

**PL e + SIL 3** The sensors of the ST series are constructed with redundant electronics. As a result, the maximum PL e and SIL 3 safety levels can still be achieved through the use of a single device on a guard. This avoids expensive wiring in the field and allows faster installation. Inside the control cabinet, the two electronic safety outputs must be connected to a safety module with OSSD inputs or to a safety PLC.

## Series connection of multiple sensors

**PL e + SIL 3** One of the most important features of the ST series from Pizzato Elettrica is the possibility of connecting up to 32 sensors in series, while still maintaining the maximum safety level (PL e) laid down in EN 13849-1.

This connection type is permissible in safety systems which have a safety module at the end of the chain that monitors the outputs of the last ST sensor.

The fact that the PL e safety level can be maintained even with 32 sensors connected in series demonstrates the extremely secure structure of each sensor of the ST series.

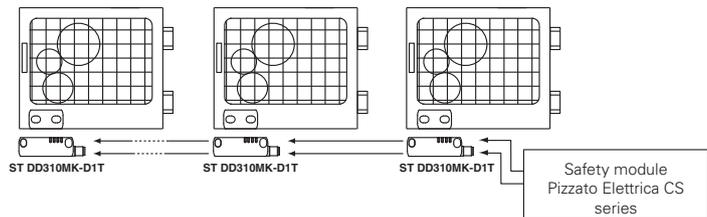

## Series connection with other devices

**PL e + SIL 3** The ST series features two safety inputs and two safety outputs, which can be connected in series with other Pizzato Elettrica safety devices. This option allows the creation of safety chains containing various devices. For example, stainless steel safety hinges (HX BEE1 series), transponder sensors (ST series) and door lock sensors (NG or NS series) can be connected in series while still maintaining the maximum PL e and SIL 3 safety levels.

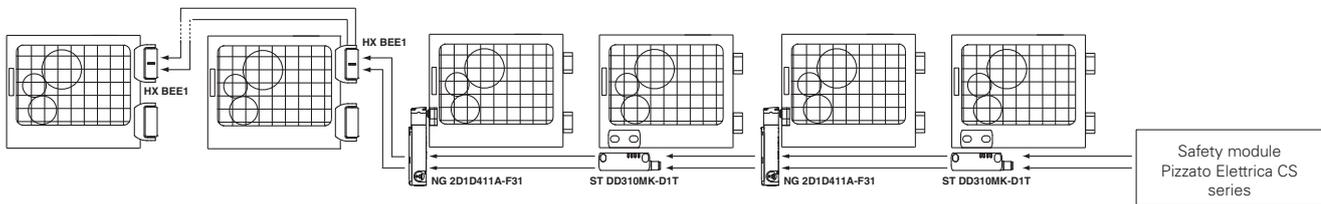

## High level coded actuators



The ST series is provided with an electronic system based on RFID technology to detect the actuator. This allows to provide each actuator with different coding and makes it impossible to tamper with a device by using another actuator of the same series. Millions of different coding combinations are possible for the actuators. They are therefore classified as high level coded actuators, according to EN ISO 14119.

## Protection degrees IP67 and IP69K

**IP69K**  
**IP67**

These devices are designed to be used in the toughest environmental conditions and they pass the IP67 immersion test acc. to EN 60529. They can therefore be used in all environments where maximum protection degree of the housing is required. Due to

their special design, these devices are suitable for use in equipment subjected to cleaning with high pressure hot water jets. These devices meet the IP69K test requirements according to ISO 20653 (water jets with 100 bar and 80°C).

## Wide actuation range

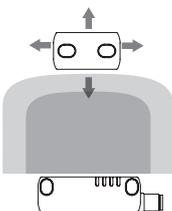

By utilising the properties of RFID technology, the sensors of the ST series have a wide actuation range, making them very well suited for applications with large tolerances or where mechanical properties change over time.

## Actuation from many directions

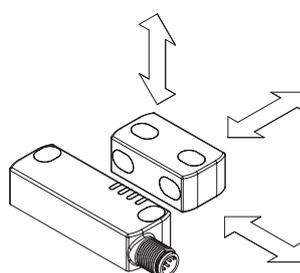

The sensors of the ST series from Pizzato Elettrica were designed to be activated from various directions, thereby providing the customer with maximum flexibility when positioning the sensors on the guards. Furthermore, the SM D•T actuator can be secured in two mutually orthogonal directions.





### Programmability

Pizzato Elettrica supplies a programmable version of the ST series sensors. With a simple and brief operation, the sensor can be programmed to recognise the code of a new actuator.

By activating a special input, the sensor is switched to a safe state, during which it waits for a new code to be accepted. As the actuator approaches, the ST sensor performs a number of checks on the code being received, whereby the code must adhere to certain parameters of RFID technology.

If the checks are successful, the sensor uses LEDs to signal the successful completion of the procedure.

After programming has been completed, the sensor only recognises the code of the last programmed actuator, thereby preserving the safety level and the reliability of the system in which it is installed.

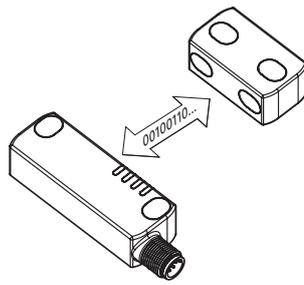

### Laser engraving

All devices are marked using a dedicated indelible laser system. These engravings are therefore suitable for extreme environments too. Thanks to this system that does not use labels, the loss of plate data is prevented and a greater resistance of the marking is achieved over time.

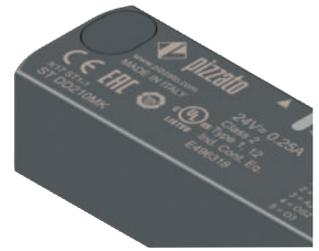

### Short signal propagation delay

One of the main features of the ST sensors is the short signal propagation time of approx. 7 ms after deactivation of the inputs.

This short signal propagation time is particularly advantageous for sensors connected in series.

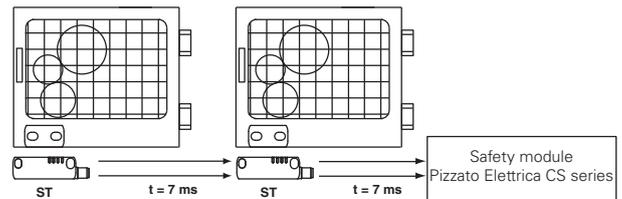

### Stainless steel fixing plates

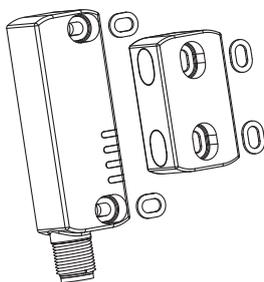

The stainless-steel fixing plates for the ST sensors not only protect the mounting eyes during installation on surfaces that are not perfectly flat, they also help the sensor better withstand mechanical loads. As a result, the system is safer and more reliable.

### Protection against tampering

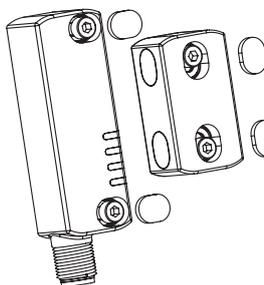

Each sensor and actuator of the ST series is supplied complete with snap-on protection caps to be applied on the holes of the fixing screws. Not only do the caps prevent dirt from accumulating and simplify cleaning, they also block access to the fastening screws of the actuator. As a result, standard screws can be used instead of tamper-proof screws.

### Insensitivity to dirt

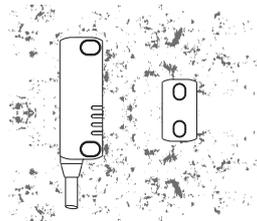

The sensors are completely sealed and retain their safety characteristics even in the presence of dirt or deposits (not ferromagnetic material). This characteristic, combined with the design without recesses, makes them particularly suitable for use in the food industry.

### Versions with increased actuation distance

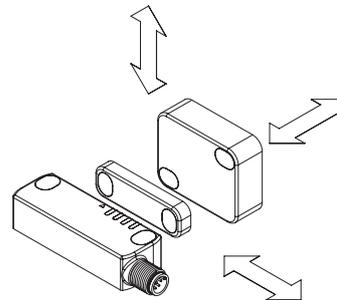

In addition to the standard actuation distance of 12 mm, sensors with an actuation distance of 20 mm are also available. The increased actuation distance of the sensors is ideal for installation situations in which it is not possible to ensure that the actuator approaches the sensor in a precise and stable manner.

### Four LEDs for immediate diagnosis

As the LEDs have been designed for quick immediate diagnosis, the status of each input and output is highlighted by one specific LED. By knowing which device is active and which door is open, it is possible to quickly identify an interruption in the safety chain as well as any internal device errors. All of this at a glance, without needing to decode complex flashing sequences.



### New compact actuators

In addition to the standard actuators, the new compact actuators SM L•T are now available to order; these actuators have a single mounting direction (frontal) and maintain the same actuation distance of 12 mm as the actuator SM D•T.

Due to the reduced thickness (just 7 mm), they can be installed in all applications with restricted space conditions and thereby enable use of RFID technology, even with guards of small dimensions.



### External device monitoring

**EDM** On request, the switch can be supplied with EDM function (External Device Monitoring). In this case, the switch itself checks the proper function of the devices connected to the safety outputs. These devices (usually relays or safety contactors) must send a feedback signal to the EDM input, which checks that the received signal is consistent with the state of the safety outputs.

### Extended supply voltage range

In addition to the standard 24 Vdc supply voltage, the ST series sensors are available with an extended supply voltage of 12 ... 24 Vdc (articles ST D•••1••). This characteristic makes them particularly suitable for use in the automotive sector, in machines powered by common battery systems, and both in light and heavy vehicles.

## Selection diagram

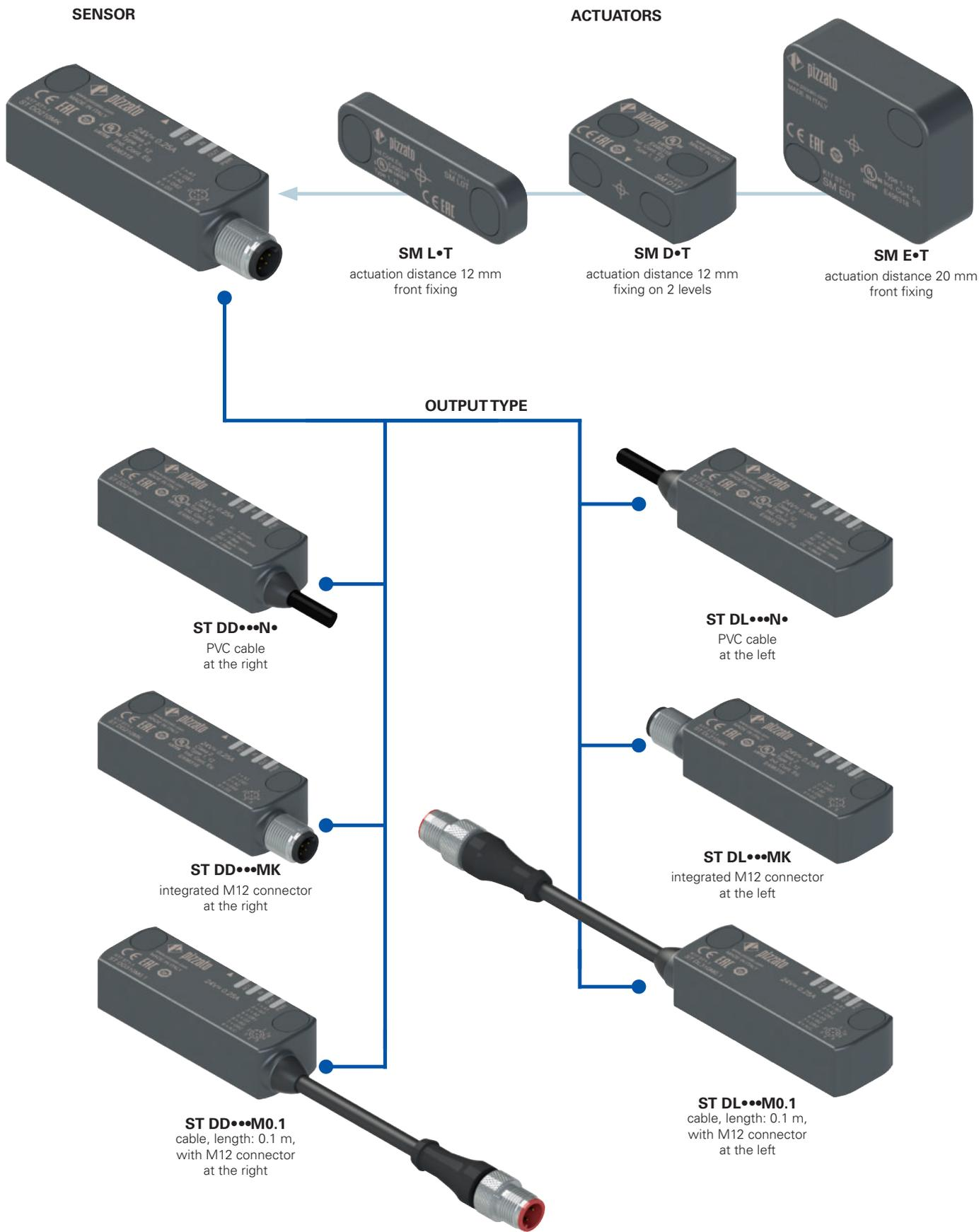

- product option
- ➔ sold separately as accessory



**Attention!** The feasibility of a code number does not mean the effective availability of a product. Please contact our sales office.

## Code structure for sensor with actuator

# ST DD420N2-D1T

### Output direction, connections

<b>D</b>	output at the right
<b>L</b>	output at the left

### Inputs and outputs

	OS safety outputs	O signalling outputs	IS safety inputs	I programming inputs	EDM inputs
<b>21</b>	2	1	-	-	-
<b>31</b>	2	1	2	-	-
<b>42</b>	2	1	2	1	-
<b>51</b>	2	1	2	-	1
<b>61</b>	2	1 (inverted)	-	-	-
<b>71</b>	2	1 (inverted)	2	-	-
<b>82</b>	2	1 (inverted)	2	1	-

Note: versions 21, 31, 51, 61, 71 are only supplied together with an actuator

### Supply voltage

<b>0</b>	24 Vdc
<b>1</b>	12 ... 24 Vdc

### Cable or connector type

<b>N</b>	PVC cable, IEC 60332-1-2 oil resistant (standard)
<b>H</b>	PUR cable, halogen free (not available with versions ST D•2••••• and ST D•6•••••)
<b>M</b>	M12 connector

### Actuator

<b>D0T</b>	standard actuator low level of coding the sensor recognises any type D0T actuator
<b>D1T</b>	standard actuator high level of coding the sensor recognises one single type D1T actuator
<b>E0T</b>	Large actuator low level of coding the sensor recognises any type E0T actuator
<b>E1T</b>	Large actuator high level of coding the sensor recognises one single type E1T actuator
<b>L0T</b>	miniaturized actuator low level of coding the sensor recognises any type L0T actuator
<b>L1T</b>	miniaturized actuator high level of coding the sensor recognises one single type L1T actuator

### Connection type

<b>0.1</b>	cable, length: 0.1 m, with M12 connector
<b>0.5</b>	cable, length: 0.5 m
...	....
<b>2</b>	cable, length: 2 m (standard)
...	....
<b>10</b>	cable, length: 10 m
<b>K</b>	integrated M12 connector

**Attention!** The feasibility of a code number does not mean the effective availability of a product. Please contact our sales office.

## Code structure for single sensor

# ST DD420N2

### Output direction, connections

<b>D</b>	output at the right
<b>L</b>	output at the left

### Inputs and outputs

	OS safety outputs	O signalling outputs	IS safety inputs	I programming inputs
<b>42</b>	2	1	2	1
<b>82</b>	2	1 (inverted)	2	1

### Supply voltage

<b>0</b>	24 Vdc
<b>1</b>	12 ... 24 Vdc

### Connection type

<b>0.1</b>	cable, length: 0.1 m, with M12 connector
<b>0.5</b>	cable, length: 0.5 m
...	....
<b>2</b>	cable, length: 2 m (standard)
...	....
<b>10</b>	cable, length: 10 m
<b>K</b>	integrated M12 connector

### Cable or connector type

<b>N</b>	PVC cable, IEC 60332-1-2 oil resistant (standard)
<b>H</b>	PUR cable, halogen free (not available with version ST D•2•••••)
<b>M</b>	M12 connector

**Attention!** Individual sensors are initially programmed with the code of the actuators with low coding level •0T.  
**Attention!** The feasibility of a code number does not mean the effective availability of a product. Please contact our sales office.

## Code structure for actuator

# SM D1T

### Design and actuation distance

<b>D</b>	standard actuator actuation distance 12 mm
<b>E</b>	large actuator actuation distance 20 mm
<b>L</b>	miniaturized actuator actuation distance 12 mm

### Actuator

<b>0T</b>	low level coded actuator the sensor recognises any type •0T actuator
<b>1T</b>	high level coded actuator the sensor recognises one single type •1T actuator



### Main features

- Actuation without contact, using RFID technology
- Digitally coded actuator
- Protection degrees IP67 and IP69K
- 4 LEDs for status display of the sensor
- Actuators with various actuation distances

### Quality marks:

UL approval: E496318  
 EC type examination certificate: M6A 18 01 75157 021  
 TÜV SÜD approval: Z10 18 01 75157 011  
 EAC approval: RU C-IT.YT03.B.00035/19

### In compliance with standards:

IEC 61508-1, IEC 61508-2, IEC 61508-3,  
 IEC 61508-4, EN ISO 13849-1, EN ISO 13849-2,  
 EN ISO 14119, EN 62061, EN 60947-5-3,  
 EN 60947-5-2, EN 60947-1, EN 61326-1,  
 EN 61326-3-1, EN 61326-3-2, EN 50581,  
 ETSI 301 489-1, ETSI 301 489-3, ETSI 300 330-2,  
 UL 508, CSA 22.2 No. 14

### Compliance with the requirements of:

Machinery Directive 2006/42/EC,  
 EMC Directive 2014/30/EC,  
 Directive 2014/53/EU - RED,  
 RoHS Directive 2011/65/EU,  
 FCC Part 15.

### Connection with safety modules for safety applications:

Connection with safety modules  
 CS AR-05•••••; CS AR-06•••••; CS AR-08•••••;  
 CS AT-0•••••; CS AT-1•••••; CS MP•••••.  
 When connected to the safety module, the sensor can be classified as a control circuit device up to PDDb (EN 60947-5-3).  
 The system can be used in safety circuits up to PL e/SIL 3/category 4 in accordance with EN ISO 13849-1.

## Technical data

### Housing

Housing made of glass fibre reinforced technopolymer, self-extinguishing.  
 Versions with integrated cable 6 x 0.5 mm<sup>2</sup> or 8 x 0.34 mm<sup>2</sup>, length 2 m, other lengths 0.5 m ... 10 m on request  
 Versions with M12 stainless steel connector  
 Versions with 0.1 m cable length and integrated M12 connector, other lengths 0.1 ... 3 m on request  
 Protection degree:

IP67 acc. to EN 60529  
 IP69K acc. to ISO 20653  
 (Protect the cables from direct high-pressure and high-temperature jets)

### General data

SIL (SIL CL) up to: SIL 3 acc. to EN 62061  
 Performance Level (PL) up to: PL e acc. to EN ISO 13849-1  
 Safety category up to: cat. 4 acc. to EN ISO 13849-1  
 Interlock, no contact, coded: type 4 acc. to EN ISO 14119  
 Level of coding acc. to EN ISO 14119: high with SM •1T actuators  
 low with SM •0T actuators

### Safety parameters:

MTTF<sub>D</sub>: 4077 years  
 PFH<sub>D</sub>: 1.20E-11  
 DC: High  
 Mission time: 20 years  
 Ambient temperature for sensors without cable: -25 ... +70 °C  
 Ambient temperature for sensors with cable: see table page 44  
 Storage and transport temperature: -25 ... +85 °C  
 Vibration resistance: 10 gn (10 ... 150 Hz) acc. to IEC 60068-2-6  
 Shock resistance: 30 gn; 11 ms acc. to EN 60068-2-27  
 Pollution degree: 3  
 Screw tightening torque: 0.8 ... 2 Nm

### Electrical data of IS1/IS2/I3/EDM inputs

Rated operating voltage  $U_{e1}$ : 24 Vdc or 12 ... 24 Vdc  
 Rated current consumption  $I_{e1}$ : 5 mA

### Electrical data of OS1/OS2 safety outputs

Rated operating voltage  $U_{e2}$ : 24 Vdc or 12 ... 24 Vdc  
 Output type: PNP type OSSD  
 Maximum current per output  $I_{e2}$ : 0.25 A  
 Minimum current per output  $I_{m2}$ : 0.5 mA  
 Thermal current  $I_{th2}$ : 0.25 A  
 Utilization category: DC13;  $U_{e2}=24$  Vdc,  $I_{e2}=0.25$  A  
 Short circuit detection: Yes  
 Overcurrent protection: Yes  
 Internal self-resettable protection fuse: 0.75 A  
 Duration of the deactivation impulses at the safety outputs: < 300  $\mu$ s  
 Permissible maximum capacitance between outputs: < 200 nF  
 Permissible maximum capacitance between output and ground: < 200 nF

### Electrical data of O3 signalling output

Rated operating voltage  $U_{e3}$ : 24 Vdc or 12 ... 24 Vdc  
 Output type: PNP  
 Maximum current per output  $I_{e3}$ : 0.1 A  
 Utilization category: DC12;  $U_{e3}=24$  Vdc;  $I_{e3}=0.1$  A  
 Short circuit detection: No  
 Overcurrent protection: Yes  
 Internal self-resettable protection fuse: 0.75 A

### Actuation data

	SMD•T	SM E•T	SM L•T
Assured operating distance $S_{op}$ :	10 mm	16 mm	10 mm
Assured release distance $S_{ar}$ :	16 mm	27 mm	16 mm
Rated operating distance $S_{n}$ :	12 mm	20 mm	12 mm
Rated release distance $S_{nr}$ :	14 mm	23 mm	14 mm
Repeat accuracy:	$\leq 10\%$ $s_n$		
Differential travel:	$\leq 20\%$ $s_n$		
RFID transponder frequency:	125 kHz		
Max. switching frequency:	1 Hz		
Distance between two sensors:	min. 50 mm		
Response time upon deactivation of input IS1 or IS2:	typically 7 ms, max. 12 ms		
Response time upon actuator removal:	typically 80 ms, max. 150 ms		

### Power supply electrical data

Rated operating voltage  $U_e$  SELV:  
 - 24 Vdc versions: 24 Vdc -15% ... +10%  
 - 12 ... 24 Vdc versions: 12 ... 24 Vdc -30% ... +25%  
 Operating current at  $U_e$  voltage:  
 - minimum: 40 mA  
 - with all outputs at maximum power: 0.7 A  
 Rated insulation voltage  $U_i$ : 32 Vdc  
 Rated impulse withstand voltage  $U_{imp}$ : 1.5 kV  
 External protection fuse: 1 A type Gg or equivalent device  
 Overvoltage category: III



### Features approved by UL

Electrical Ratings: 24 Vdc Class 2, 0,25 A (resistive load)  
 Environmental Ratings: Types 1, 4X, 6, 12, 13  
 Accessory for series ST for actuator switch series SMD, SM E, SM G, SM L.

Please contact our technical department for the list of approved products.

### Features approved by TÜV SÜD

Supply voltage: 24 Vdc  
 12 ... 24 Vdc  
 Rated operating current (max.): 0.25 A  
 Ambient temperature: -25 °C ... + 70°C  
 Protection degree: IP67 and IP69K  
 PL, category: PL e, category 4

In compliance with standards: Machine Directive 2006/42/EEC  
 EN ISO 13849-1:2015, EN 60947-5-3:2013, EN 50178:1997,  
 EN 61508-1:2010 (SIL 3), EN 61508-2:2010 (SIL 3), EN 61508-3:2010  
 (SIL 3), EN 61508-4:2010 (SIL 3), IEC 62061:2005/A2:2015 (SIL CL 3)

Please contact our technical department for the list of approved products.

### Selection table for sensors with high level coded actuators

OS safety outputs	O signalling outputs	IS safety inputs	I programming inputs	EDM inputs	Programmable	cable, length: 0.1 m, with M12 connector at the right		cable, length: 0.1 m, with M12 connector at the left		integrated cable, at the right	integrated cable, at the left	M12 connector, at the right	M12 connector, at the left
						2	1	2	1	2	1	2	1
2	1	-	-	-	-	/	/	/	/	ST DD210N•D1T	ST DL210N•D1T	ST DD210MK-D1T	ST DL210MK-D1T
2	1	2	-	-	-	ST DD310M0.1-D1T	ST DL310M0.1-D1T	ST DD310N•D1T	ST DL310N•D1T	ST DD310MK-D1T	ST DL310MK-D1T	ST DD310MK-D1T	ST DL310MK-D1T
2	1	2	1	-	•	ST DD420M0.1-D1T	ST DL420M0.1-D1T	ST DD420N•D1T	ST DL420N•D1T	ST DD420MK-D1T	ST DL420MK-D1T	ST DD420MK-D1T	ST DL420MK-D1T
2	1	2	-	1	-	ST DD510M0.1-D1T	ST DL510M0.1-D1T	ST DD510N•D1T	ST DL510N•D1T	ST DD510MK-D1T	ST DL510MK-D1T	ST DD510MK-D1T	ST DL510MK-D1T

To order a product with E•T or L•T actuator replace D with E or L in the codes shown above.  
 For example: ST DD310M0.1-D•T → ST DD310M0.1-E•T or ST DD310M0.1-L•T

### Selection table for sensors

OS safety outputs	O signalling outputs	IS safety inputs	I programming inputs	EDM inputs	Programmable	cable, length: 0.1 m, with M12 connector at the right		cable, length: 0.1 m, with M12 connector at the left		integrated cable, at the right	integrated cable, at the left	M12 connector, at the right	M12 connector, at the left
						2	1	2	1	2	1	2	1
2	1	2	1	-	•	ST DD420M0.1	ST DL420M0.1	ST DD420N•	ST DL420N•	ST DD420MK	ST DL420MK	ST DD420MK	ST DL420MK

### Selection table for actuators

Level of coding acc. to ISO 14119	actuation distance 12 mm		actuation distance 20 mm
	SM L0T	SM D0T	SM E0T
low	SM L1T	SM D1T	SM E1T
high	SM L1T	SM D1T	SM E1T

The use of RFID technology in ST series sensors makes them suitable for several applications. Pizzato Elettrica offers two different versions of actuators, in order to best suit customers' specific needs.

Type •0T actuators are all encoded with the same code. This implies that a sensor associated with an actuator type •0T can be activated by other actuators type •0T.

Type •1T actuators are always encoded with different codes. This implies that a sensor associated with an actuator type •1T can be activated only by a specific actuator. Another •1T type actuator will not be recognised by the sensor until a new association procedure is carried out (reprogramming). After reprogramming, the old actuator type •1T will no longer be recognized.

Reprogramming of the actuator can be performed repeatedly.

### Ambient temperature for sensors with cable

	Connection type	Output with cable		Output with cable and M12 connector
		N	H	
Cable features	Cable type	N	H	M12 connector
	Conductors	8x0.34 mm <sup>2</sup>	8x0.34 mm <sup>2</sup>	8x0.25 mm <sup>2</sup>
	Application field	General	General, mobile installation	General
	In compliance with standards	03VV-F	03E7Q-H	03VV-H
	Sheath	PVC OIL RESISTANT	PUR Halogen Free	PVC OIL RESISTANT
	Self-extinguishing	IEC 60332-1-2 UL 758:FT1 CEI 20-22 II	IEC 60332-1-2 UL 758:FT1	IEC 60332-1-2 UL 758:FT1 CEI 20-22 II
	Oil resistant	UL 758 CSA 22.2 N°210	UL 758 CSA 22.2 N°210	UL 758 CSA 22.2 N°210
	Max. speed	/	300 m/min.	50 m/min
	Max. acceleration	/	30 m/s <sup>2</sup>	5 m/s <sup>2</sup>
	Minimum bending radius	108 mm	70 mm	90 mm
	Outer diameter	7 mm	7 mm	6 mm
	End stripped	80 mm	80 mm	/
	Copper conductors	Class 5 IEC 60228	Class 6 IEC 60228	Class 6 IEC 60228
Ambient temperature	Engraving	6276	6283	6275
	Cable, fixed installation	-25°C +70°C	-25°C +70°C	-25°C +70°C
	Cable, flexible installation	-5°C +70°C	-25°C +70°C	-15°C +70°C
	Cable, mobile installation	/	-25°C +70°C	-15°C +70°C
Approvals	CE cULus TÜV EAC	CE cULus TÜV EAC	CE cULus TÜV EAC	CE cULus TÜV EAC

→ The 2D and 3D files are available at [www.pizzato.com](http://www.pizzato.com)

## Complete safety system

The use of complete and tested solutions guarantees the electrical compatibility between the sensors of the ST series and the safety modules from Pizzato Elettrica, as well as high reliability. The sensors have been tested with the modules listed in the adjacent table.

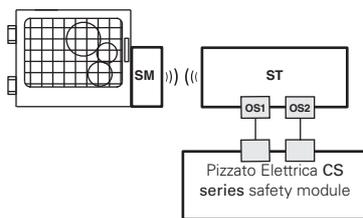

ST sensors can be used as individual devices provided that the outputs be evaluated by a Pizzato Elettrica safety module (see table for combinable safety modules).

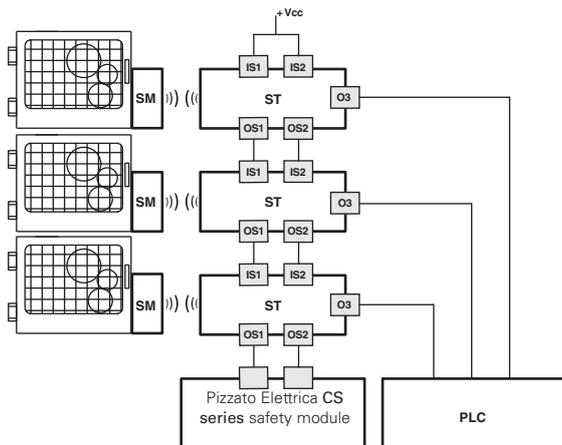

Possibility of series connection of multiple sensors for simplifying the wiring of the safety system, whereby only the outputs of the last sensor are evaluated by a Pizzato Elettrica safety module (see table with compatible safety modules). Each ST sensor is equipped with a signalling output, which – depending on the version – is activated or deactivated when the respective guard is closed. Depending on the specific requirements of the application, this information can be evaluated by a PLC.

## Compatible safety modules

Sensors	Safety modules	Safety module output contacts		
		Instantaneous safety contacts	Delayed safety contacts	Signalling contacts
ST D•••••	CS AR-05•••••	3NO	/	1NC
	CS AR-06•••••	3NO	/	1NC
	CS AR-08•••••	2NO	/	/
	CS AT-0•••••	2NO	2NO	1NC
	CS AT-1•••••	3NO	2NO	/
	CS MP•••••	see p. 277		
	CS MF•••••	see p. 305		

All ST series sensors can be connected, provided that compatibility is checked, to safety modules or safety PLCs with OSSD inputs.

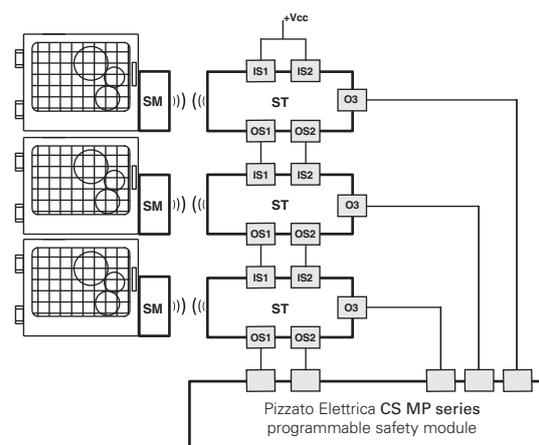

Possibility of series connection of multiple sensors for simplifying the wiring of the safety system, whereby only the outputs of the last sensor are evaluated by a Pizzato Elettrica safety module of the CS MP series. Both the safety-relevant evaluation and the evaluation of the signalling outputs are performed by the CS MP series.

## Internal block diagram (ST D•5•••••)

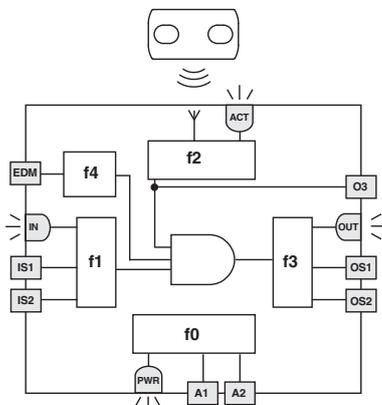

The adjacent diagram illustrates five logical, linked sub-functions of the sensor.

Function f0 is a basic function and includes the monitoring of the power supply as well as internal, cyclical tests.

Function f1 monitors the status of the inputs, whereas function f2 monitors the position of the actuator in the detection area.

Function f3 is intended to activate or deactivate the safety outputs and check for any faults or short circuits in the outputs.

In the EDM versions, function f4 checks the EDM signal on state changes of the safety outputs.

The safety-related function, which combines the sub-functions mentioned above, only activates the safety outputs if the input signals are correctly applied and the actuator is located within the safe zone.

The status of each sub-function is displayed by corresponding LEDs (PWR, IN, ACT, OUT), thereby providing a quick overview of the operating status of the sensor.

LED	Function
ACT	state of actuator / O3 output
IN	status of safety inputs
OUT	status of safety outputs
PWR	Power supply/self-diagnosis



### Limit activation zone and safe activation zone (ST D•4••••)

When aligning the sensor with the actuator, the status LEDs use various colours to indicate whether the actuator is in the limit activation zone or in the safe activation zone. The following figures use the ST DD420MK-D1T sensor as an example.

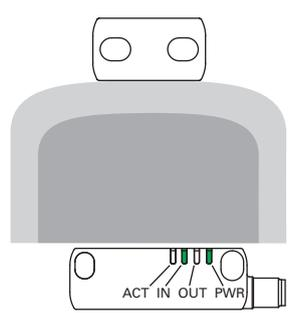

Operating voltage is applied to the sensor, (LED PWR on, green), the inputs are enabled (LED IN on, green), the outputs are deactivated (LED OUT off). The actuator is outside of the actuation zone (LED ACT off).

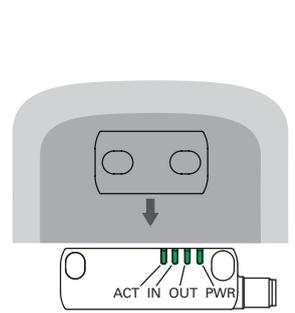

If the actuator is moved inside the safe activation zone (dark grey area), the ACT LED on the sensor illuminates (green) and it activates the outputs (LED OUT on, green).

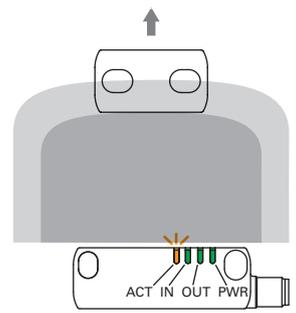

When the actuator leaves the safe zone, the sensor keeps the safety outputs enabled. Entry into the limit activation zone (light grey area) is, however, indicated by the ACT LED (orange/green, flashing).

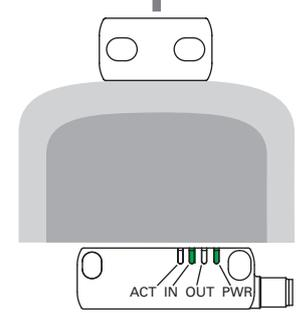

As soon as the actuator exits the limit activation zone, the sensor deactivates the outputs and switches off the OUT and ACT LEDs.

### Operating states (ST D•4••••)

PWR LED	OUT LED	IN LED	ACT LED	Sensor state	Description
○	○	○	○	OFF	Sensor off.
●	○	○	○	POWER ON	Internal tests upon activation.
●	*	○	*	RUN	Sensor with inactive inputs.
●	*	●	*	RUN	Activation of the inputs.
●	*	◌	*	RUN	Input incoherence. Recommended action: check for presence and/or wiring of inputs.
●	*	*	●	RUN	Actuator in safe area. O3 signalling output active.
●	*	*	◌	RUN	Actuator in limit activation zone, O3 active. Recommended action: bring the sensor back to the safe area.
●	●	●	●	RUN	Activation of the inputs. Actuator in safe area and safety outputs active.
●	◌	*	*	ERROR	Error on outputs. Recommended action: check for any short circuits between the outputs, outputs and ground or outputs and power supply, then restart the sensor.
●	*	*	*	ERROR	Internal error. Recommended action: restart the sensor. If the failure persists, replace the sensor.

Legend: ○ = off ● = on ◌ = flashing ◐ = alternating colours \* = indifferent

### External device monitoring (EDM)

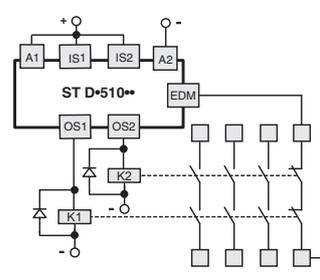

The ST D•51••• version, in addition to maintaining the operating and safety characteristics of the ST series, allows control of **forcibly guided NC contacts of contactors or relays** controlled by the safety outputs of the sensor itself. As an alternative to the relays or contactors you can use Pizzato Elettrica expansion modules CS ME-03. See page 263.

This check is carried out by monitoring the EDM input (External Device Monitoring as defined in EN 61496-1) of the sensor.

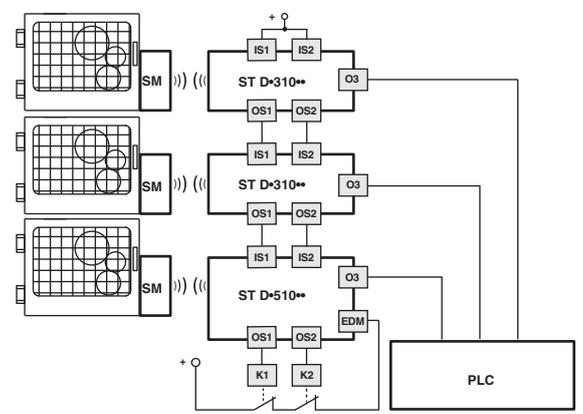

This version, with the IS safety inputs, **can be used at the end of a series of ST sensors, up to a maximum number of 32 devices**, while maintaining the maximum PL e safety level according to EN ISO 13849-1.

For specific applications, this solution allows you to dispense with the safety module connected to the last device in the chain.

### O3 output inverted (ST D•6••••, ST D•7••••, ST D•8••••)

The version with inverted O3 signalling output allows checking of the actual electrical connection of the sensor by an external PLC. The O3 output will be activated when the actuator is removed and the OS safety outputs are switched off.

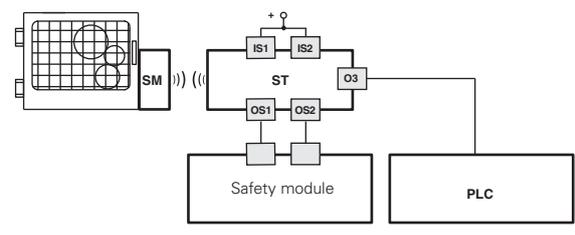

## Connection with safety modules

Connections with CS AR-08•••• safety modules

Input configuration with monitored start  
2 channels / Category 4 / up to SIL 3 / PL e

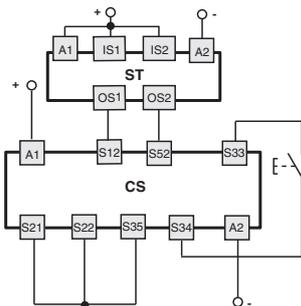

Connections with CS AR-05•••• / CS AR-06•••• safety modules

Input configuration with manual start (CS AR-05••••) or monitored start (CS AR-06••••)  
2 channels / Category 4 / up to SIL 3 / PL e

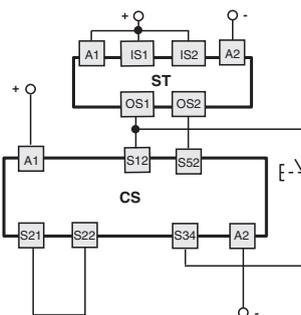

Connections with CS AT-0••••• / CS AT-1••••• safety modules

Input configuration with monitored start  
2 channels / Category 4 / up to SIL 3 / PL e

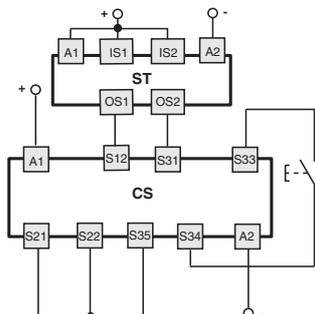

For features of the safety modules see page 213.

Connection with safety module CS MP•••••

The connections vary according to the program of the module  
Category 4 / up to SIL 3 / PL e

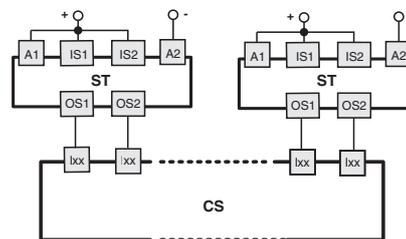

For application examples, see page 276.

## Internal device connections

### 5-pole versions

ST D•2•••••, ST D•6•••••

M12 connector	Cable	Connection
1	brown	A1 (+)
2	red/white	OS1
3	blue	A2 (-)
4	black/white	OS2
5	black	O3
/	red	not connected

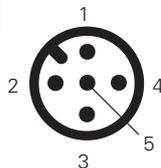

### 8-pole versions

ST D•3•••••, ST D•4•••••, ST D•5•••••, ST D•7•••••, ST D•8•••••

M12 connector	Cable	Connection
1	brown	A1 (+)
2	red	IS1
3	blue	A2 (-)
4	red/white	OS1
5	black	O3
6	purple	IS2
7	black/white	OS2
8	purple/white	not connected <sup>(a)</sup> I3 <sup>(b)</sup> EDM <sup>(c)</sup>

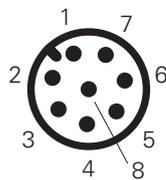

<sup>(a)</sup> for articles ST D•3•••••, ST D•7•••••.  
<sup>(b)</sup> for articles ST D•4•••••, ST D•8•••••.  
<sup>(c)</sup> for articles ST D•5•••••.

### Legend

- A1-A2: supply
- IS1-IS2 Safety inputs
- OS1-OS2: safety outputs
- O3: signalling output
- I3: programming input
- EDM: input for monitoring of NC contacts of the contactors

NOTE: Versions with customised pin assignments are available on request.

For female connectors, see page 321.

## Series connection

To simplify series connections of the devices, various M12 connectors are available that allow complete wiring.

This solution significantly reduces installation times while at the same time maintaining the maximum safety levels PL e and SIL 3.

For further information see page 326.

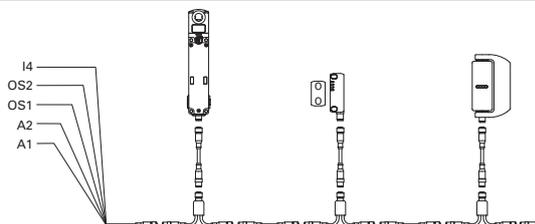





## Description



The HP - HC series hinge switches from Pizzato Elettrica combine safety and style in a single product. The electric switch is fully integrated into the mechanical hinge so that it is virtually invisible to an inexperienced eye. This, besides from being an aesthetic advantage, guarantees greater safety as a switch which is difficult to identify is consequently even more difficult to tamper with. The rear mounting without screws in sight and the very precise line mean the switch can be perfectly integrated even with guards of machinery with a very precise design. Complementary hinges with purely mechanical functions are also available to ensure perfect alignment with the rest of the machine.

## Adjustment of the switching point

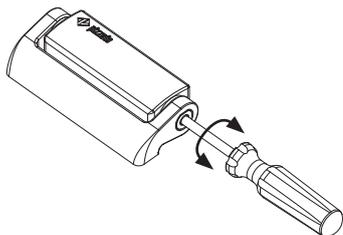

The switching point of the switches can be set with a Phillips head screwdriver. Adjusting the switching point allows for any calibration for large size guards. After calibrating the switch, it is always necessary to close the hole using the safety cap supplied.

## Basic activation angle variants

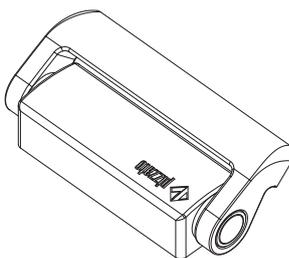

On request, versions with a switch activation angle of 15° multiples (e.g. 45° or 90°) are available. The different activation angle does not exclude the possibility of adjustment of the switching point by means of the adjustment screw in the switch. Any change in the operating angle clearly does not alter the maximum mechanical switch travel.

## Integrated M12 connector

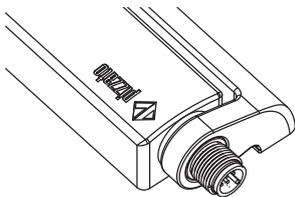

Versions with connection from the top or the bottom are available with integrated M12 connector. The use of versions with connectors permits faster wiring if guards need to be moved from the test location to the installation site.

## Opening angle up to 180°

The mechanical design of the switch also allows use on guards with an opening angle of up to 180°.

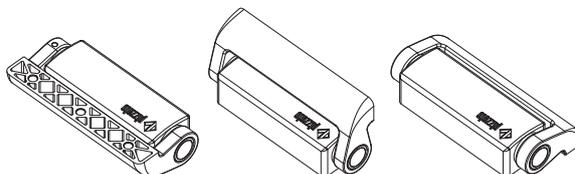

## Cable with connector at the back

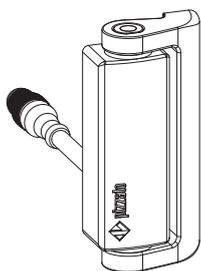

The version with a rear cable and M12 connector is the best combination between aesthetics and connection ease. If machines need to be assembled at the customer's site, this solution allows the wiring to be hidden. At the same time, it facilitates the connection and disconnection of the wiring from inside the machinery.

## Versions for glass or polycarbonate doors

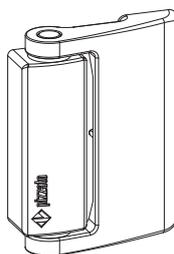

A version of the switch developed exclusively for glass and polycarbonate doors without frame is available. Installation is facilitated by the larger supporting arm and the spaced fixing points; these also prevent the formation of cracks caused by holes located too close to the edge of the guard. It is necessary to verify that the switch is not used as a mechanical stop for the door.

## Protection degrees IP67 and IP69K

**IP69K**  
**IP67**

These devices are designed to be used in the toughest environmental conditions and they pass the IP67 immersion test acc. to EN 60529. They can therefore be used in all environments where maximum protection degree of the housing is required. Due to

their special design, these devices are suitable for use in equipment subjected to cleaning with high pressure hot water jets. These devices meet the IP69K test requirements according to ISO 20653 (water jets with 100 bar and 80°C).

## Additional hinges

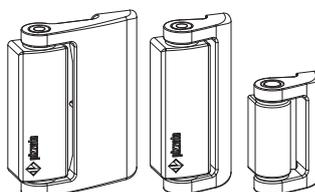

To complete the installation, various types of additional hinges are available to be used in a variable number depending on the weight of the guard. These hinges have the same aesthetic but cost less as they contain no electrical parts.

**Application examples**

- Switch without mounting plate.
- Rear fixing.
- Cable output at the back.



- Switch with angular mounting plate for slotted profile.
- Fixing with internal screws.
- Output with M12 connector at the bottom.



- Switch with straight mounting plate for front slotted profile.
- Fixing with screws at the back.
- Cable output at the bottom.

Closed door



Open door

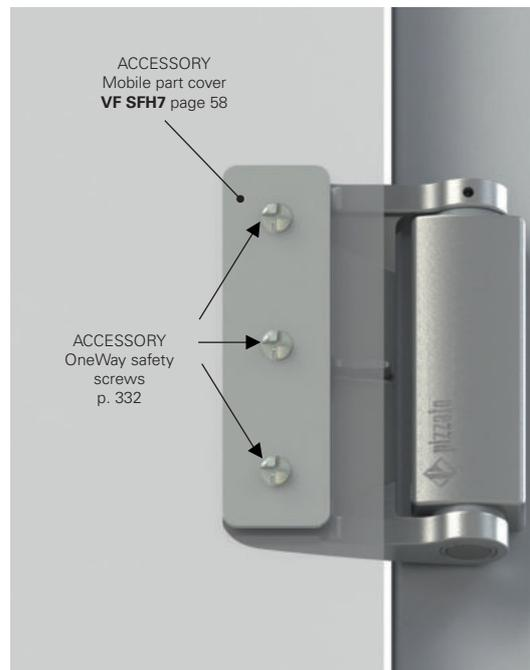

- Direct fixing to the polycarbonate plate
- Switch without mounting plate
- Fixing with internal screws
- Output with connector at the back.

Selection diagram

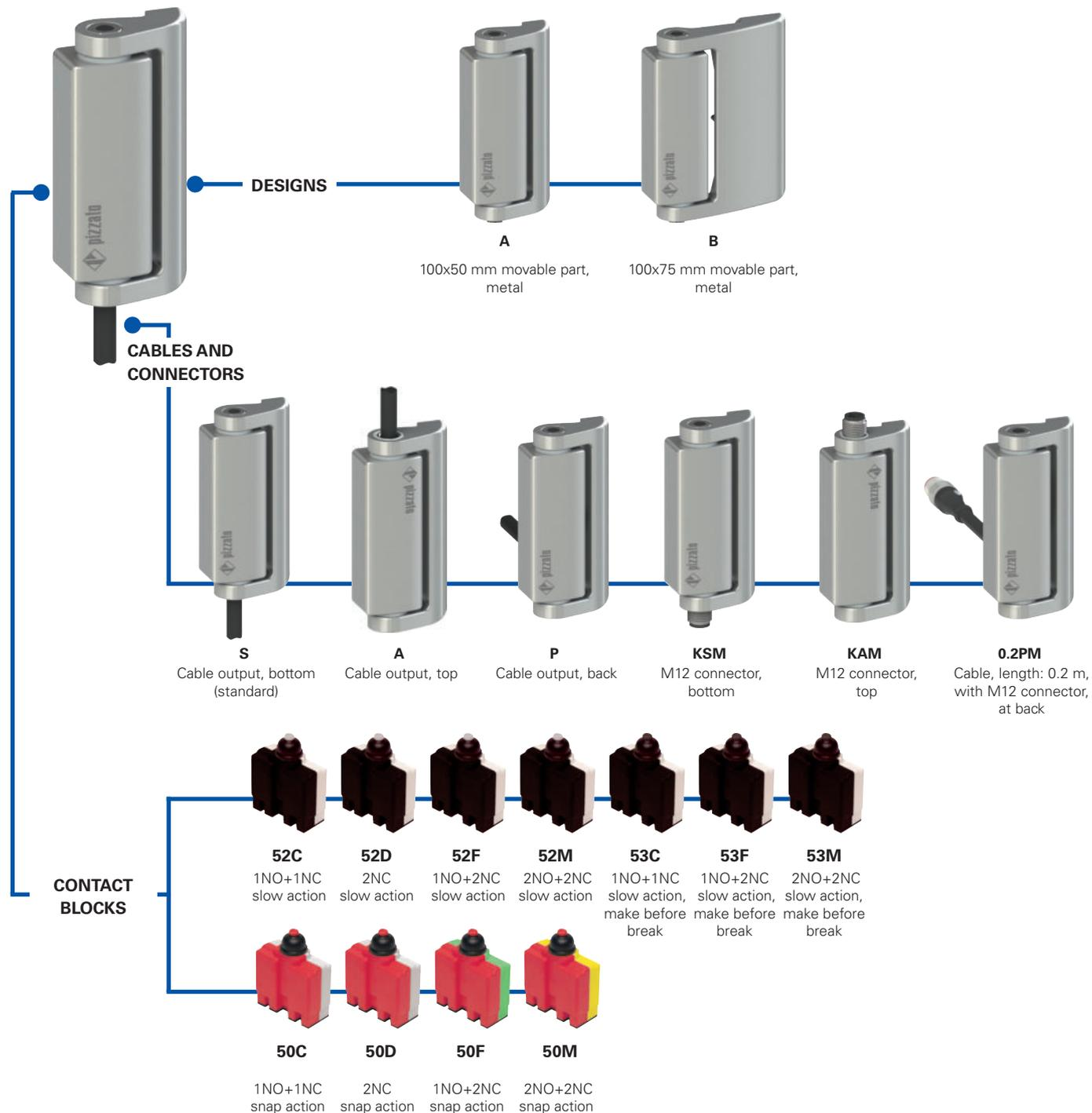

ADDITIONAL HINGES



—●— product option

**Code structure****Attention!** The feasibility of a code number does not mean the effective availability of a product. Please contact our sales office.

article
options

**HP AA052C-2SNGH15**

Movable part	
<b>A</b>	100x50 mm movable part, metal
<b>B</b>	100x75 mm movable part, metal

Contact blocks	
<b>52C</b>	1NO+1NC, slow action
<b>52D</b>	2NC, slow action
<b>52F</b>	1NO+2NC, slow action
<b>52M</b>	2NO+2NC, slow action
<b>53C</b>	1NO+1NC, slow action, make before break
<b>53F</b>	1NO+2NC, slow action, make before break
<b>53M</b>	2NO+2NC, slow action, make before break
<b>50C</b>	1NO+1NC, snap action
<b>50D</b>	2NC, snap action
<b>50F</b>	1NO+2NC, snap action
<b>50M</b>	2NO+2NC, snap action

The versions with snap-action contact blocks are recommended for doors having a radius not greater than 600 mm.

Connection type	
<b>0.2</b>	cable, length: 0.2 m with M12 connector (available for 0.2 PM versions only)
<b>0.5</b>	cable, length: 0.5 m
...	.....
<b>2</b>	cable, length: 2 m (standard)
...	.....
<b>10</b>	cable, length: 10 m
<b>K</b>	integrated M12 connector

Activation angle	
	0° activation angle (standard)
<b>H15</b>	15° activation angle
<b>H30</b>	30° activation angle
<b>H45</b>	45° activation angle
<b>H60</b>	60° activation angle
<b>H75</b>	75° activation angle
<b>H90</b>	90° activation angle

Contact type	
	silver contacts (standard)
<b>G</b>	silver contacts with 1 µm gold coating

Cable or connector type	
<b>N</b>	PVC cable, IEC 60332-1-2 oil-resistant (standard)
<b>E</b>	PVC cable, IEC 60332-1-2 (with 2 contacts only)
<b>H</b>	PUR cable, halogen free
<b>R</b>	cable for railway applications (EN 50306-4)
<b>M</b>	M12 connector

Output direction, connections	
<b>S</b>	movable part at the right and bottom output
<b>P</b>	movable part at the right and output at the back
<b>A</b>	movable part at the right and output at top
<b>Q</b>	movable part at the left and output at the back

**Code structure for additional hinges****HC AA**

Additional hinges (H x L)	
<b>HC AA</b>	100.6 x 49 mm
<b>HC AB</b>	100.6 x 79 mm
<b>HC LL</b>	65 x 44.5 mm



### Main features

- Metal housing, cable output at top, bottom or back
- 4 types of integrated cable available
- Versions with M12 connector
- Protection degrees IP67 and IP69K
- 11 contact blocks with positive opening  $\oplus$
- Additional hinges without contacts

### Quality marks:



IMQ approval:	CA02.03746
UL approval:	E131787
CCC approval:	2013010305647255
EAC approval:	RU C-IT.YT03.B.00035/19

### Technical data

#### Housing

Metal housing, powder-coated  
 Versions with integrated cable, length 2 m, other lengths from 0.5 ... 10 m on request  
 Versions with integrated M12 connector  
 Versions with M12 connector and 0.2 m cable, other lengths from 0.1 ... 3 m on request  
 Protection degree:

IP67 acc. to EN 60529  
 IP69K acc. to ISO 20653  
 (Protect the cables from direct high-pressure and high-temperature jets)

Corrosion resistance in saline mist:  $\geq 300$  hours in NSS acc. to ISO 9227

#### General data

SIL (SIL CL) up to: SIL 3 acc. to EN 62061  
 Performance Level (PL) up to: PL e acc. to EN ISO 13849-1  
 Mechanical interlock, not coded: type 1 acc. to EN ISO 14119  
 Safety parameters:  
 $B_{10D}$ : 5,000,000 for NC contacts  
 Mission time: 20 years  
 Ambient temperature for hinges without cable: -25°C ... +80°C (standard)  
 -40°C ... +80°C (T6 option)  
 Ambient temperature for hinges with cable: See table on page 54  
 Max. actuation frequency: 1200 operating cycles/hour  
 Mechanical endurance: 1 million operating cycles  
 Max. actuation speed: 90°/s  
 Min. actuation speed: 2°/s  
 Mounting position: any  
 Tightening torque, M5 screws: 3 ... 5 Nm

#### Electrical data

Rated impulse withstand voltage  $U_{imp}$ : 4 kV  
 Conditional short circuit current: 1000 A acc. to EN 60947-5-1  
 Pollution degree: 3

#### In compliance with standards:

IEC 60947-5-1, IEC 60947-1, IEC 60204-1, EN ISO 14119, EN ISO 12100, IEC 60529, EN 50581, ISO 20653, UL 508, CSA 22.2 No.14.

#### Approvals:

EN 60947-5-1, UL 508, CSA 22.2 No.14, GB/T14048.5-2017.

#### Compliance with the requirements of:

Machinery Directive 2006/42/EC, EMC Directive 2014/30/EU, RoHS Directive 2011/65/EU.

#### Positive contact opening in conformity with standards:

IEC 60947-5-1, EN 60947-5-1.

**⚠ If not expressly indicated in this chapter, for correct installation and utilization of all articles see the instructions given on pages 337 to 350.**

**⚠ Important: Switch off the circuit voltage before disconnecting the connector from the switch. The connector is not suitable for separation of electrical loads. According to EN 60204-1, versions with 8-pole M12 (2NO+2NC) connector can be used only in SELV circuits.**

### Features approved by IMQ

Rated insulation voltage ( $U_i$ ):	250 Vac
Conventional free air thermal current (Ith):	10 A (1-2 contacts) / 6 A (2-3 contacts) / 4 A (4 contacts or 5-pole M12 connector)
Protection against short circuits (fuse):	10 A (1-2 contacts) / 6 A (2-3 contacts) / 4 A (4 contacts or 5-pole M12 connector) type gG
Rated impulse withstand voltage ( $U_{imp}$ ):	4 kV
Protection degree of the housing:	IP67
MA terminals (crimped terminals)	
Pollution degree:	3
Utilization category:	AC15 / DC13 (with connector)
Operating voltage ( $U_o$ ):	250 Vac (50 Hz) / 24 Vdc (with connector)
Operating current ( $I_o$ ):	3 A / 2 A (with connector)

Forms of the contact element: X, Y, X+Y, X+X, Y+Y, Y+Y+X, X+X+Y, X+X+Y+Y  
 Positive opening contacts on contact blocks 50A, 50C, 50D, 50F, 50G, 50M, 51A, 51C, 51D, 51F, 51G, 51M, 52A, 52C, 52D, 52F, 52G, 52M, 53A, 53C, 53D, 53F, 53G, 53M

In compliance with standards: EN 60947-1, EN 60947-5-1, fundamental requirements of the Low Voltage Directive 2014/35/EU.

**Please contact our technical department for the list of approved products.**

### Features approved by UL

Electrical Ratings:	R300 pilot duty (28 VA, 125-250 Vdc) B300 pilot duty (360 VA, 120-240 Vac) (1-2-3 cont.) C300 pilot duty (180 VA, 120-240 Vac) (4 cont. or M12 connector)
Environmental Ratings:	Type 1

**Please contact our technical department for the list of approved products.**



## Ambient temperatures for hinges with cable and electrical data

	Output with cable										Output with M12 connector	
	2 contacts				3 contacts			4 contacts			2 contacts	3 or 4 contacts
	E	N	H	R	N	H	N	R	M12 connector, 5-pole	M12 connector, 8-pole		
<b>Connection type</b>												
<b>Contact blocks</b>												
<b>Cable or connector type</b>	E	N	H	R	N	H	N	R	M12 connector, 5-pole	M12 connector, 8-pole		
<b>Conductors</b>	5x0.75 mm <sup>2</sup>	5x0.75 mm <sup>2</sup>	5x0.75 mm <sup>2</sup>	5x0.5mm <sup>2</sup>	7x0.5 mm <sup>2</sup>	7x0.5 mm <sup>2</sup>	9x0.34 mm <sup>2</sup>	9x0.5 mm <sup>2</sup>	5x0.25 mm <sup>2</sup>	8x0.25 mm <sup>2</sup>		
<b>Application field</b>	General	General	General, mobile installation	Rail	General	General, mobile installation	General	Rail	General	General		
<b>In compliance with standards</b>	H05VV-F	H05VV5-F	05EQ-H	EN50306-4 IE-300V 9GD 5 mm <sup>2</sup> MM-90 EN 50306-4 EN 45545	03VV-F	03E7Q-H	03VV-F	EN50306-4 1P-300V- 9GD 5 mm <sup>2</sup> MM-90 EN 50306-4 EN 45545	03VV-H	03VV-H		
<b>Sheath</b>	PVC	PVC OIL RESISTANT	PUR HALOGEN FREE	/	PVC OIL RESISTANT	PUR HALOGEN FREE	PVC OIL RESISTANT	/	PVC OIL RESISTANT	PVC OIL RESISTANT		
<b>Self-extinguishing</b>	IEC 60332-1-2	IEC 60332-1-2 UL 758:FT1 CEI 20-22 II	IEC 60332-1-2 UL 758:FT1	IEC 60332-1 EN 50305 EN 50306-1	IEC 60332-1-2 UL 758:FT1 CEI 20-22 II	IEC 60332-1-2 UL 758:FT1	IEC 60332-1-2 UL 758:FT1 CEI 20-22 II	IEC 60332-1 EN 50305 EN 50306-1	IEC 60332-1-2 CEI 20-22 II UL 758:FT1	IEC 60332-1-2 CEI 20-22 II UL 758:FT1		
<b>Oil resistant</b>	/	UL 758 CSA 22.2 N°210	UL 758 CSA 22.2 N°210	/	UL 758 CSA 22.2 N°210	UL 758	UL 758 CSA 22.2 N°210	/	UL 758 CSA 22.2 N°210	UL 758 CSA 22.2 N°210		
<b>Max. speed</b>	/	/	300 m/min	/	/	300 m/min	/	/	50 m/min	50m/min		
<b>Max. acceleration</b>	/	/	30 m/s <sup>2</sup>	/	/	30 m/s <sup>2</sup>	/	/	5 m/s <sup>2</sup>	5m/s <sup>2</sup>		
<b>Minimum bending radius</b>	80 mm	80 mm	80 mm	60 mm	108 mm	80 mm	108 mm	65 mm	75 mm	90 mm		
<b>Outer diameter</b>	8 mm	8 mm	8 mm	6 mm	7 mm	7 mm	7 mm	6.5 mm	6 mm	6 mm		
<b>End stripped</b>	80 mm	80 mm	80 mm	80 mm	80 mm	80 mm	80 mm	80 mm	/	/		
<b>Copper conductors IEC 60228</b>	Class 5	Class 5	Class 6	Class 5	Class 5	Class 6	Class 5	Class 5	Class 6	Class 6		
<b>Engraving</b>	Standard	6268	6280	Standard	6274	6282	6278	Standard	6267	6275		
<b>Ambient temperature with cable extended (T6)</b>	Cable, fixed installation	-15°C +60°C	-25°C +80°C	-25°C +80°C	-25°C +80°C	-25°C +80°C	-25°C +80°C	-25°C +80°C	-25°C +80°C	-25°C +80°C	-25°C +80°C	
	Cable, flexible installation	+5°C +60°C	-5°C +80°C	-25°C +80°C	-25°C +80°C	-5°C +80°C	-25°C +80°C	-5°C +80°C	-25°C +80°C	-15°C +80°C	-15°C +80°C	
	Cable, mobile installation	/	/	-25°C +80°C	/	/	-25°C +80°C	/	/	-15°C +80°C	-15°C +80°C	
	Cable, fixed installation	/	/	-40°C +80°C	-40°C +80°C	/	-40°C +80°C	/	-40°C +80°C	/	/	
	Cable, flexible installation	/	/	-40°C +80°C	-40°C +80°C	/	-40°C +80°C	/	-40°C +80°C	/	/	
	Cable, mobile installation	/	/	-40°C +80°C	/	/	-40°C +80°C	/	/	/	/	
<b>Electrical data</b>	Thermal current I <sub>th</sub>	10 A	10 A	10 A	6 A	6 A	6 A	3 A	4 A	4 A	2 A	
	Rated insulation voltage U <sub>i</sub>	250 Vac	250 Vac	250 Vac	250 Vac	250 Vac	250 Vac	250 Vac	250 Vac	250 Vac 300 Vdc	30 Vac 36 Vdc	
	Protection against short circuits (fuse)	10 A 500 V type gG	10 A 500 V type gG	10 A 500 V type gG	6 A 500 V type gG	6 A 500 V type gG	6 A 500 V type gG	3 A 500 V type gG	4 A 500 V type gG	4 A 500 V type gG	2 A 500V type gG	
	Utilization category DC13	24 V	2 A	2 A	2 A	2 A	2 A	2 A	2 A	2 A	2 A	2 A
		125 V	0.4 A	0.4 A	0.4 A	0.4 A	0.4 A	0.4 A	0.4 A	0.4 A	0.4 A	/
		250 V	0.3 A	0.3 A	0.3 A	0.3 A	0.3 A	0.3 A	0.3 A	0.3 A	0.3 A	/
	Utilization category AC15	24 V	4 A	4 A	4 A	4 A	4 A	4 A	3 A	4 A	4 A	2 A
120 V		4 A	4 A	4 A	4 A	4 A	4 A	3 A	4 A	4 A	/	
250 V		4 A	4 A	4 A	4 A	4 A	4 A	3 A	4 A	4 A	/	
Approvals	CE cULus IMQ EAC CCC	CE cULus IMQ EAC CCC	CE cULus IMQ EAC CCC	CE IMQ EAC CCC	CE cULus IMQ EAC CCC	CE cULus IMQ EAC CCC	CE cULus IMQ EAC CCC	CE cULus IMQ EAC CCC	CE IMQ EAC CCC	CE cULus IMQ EAC CCC	CE cULus EAC	

### Internal cable wiring

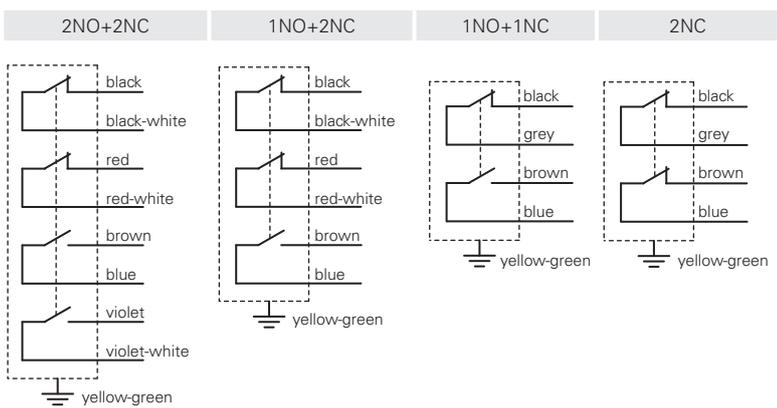

### Connector pin assignment

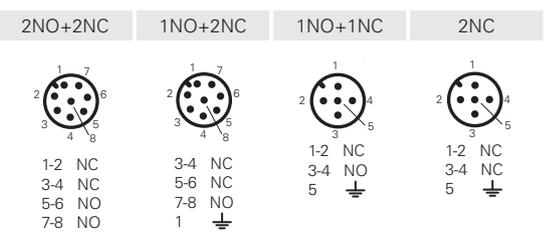

Female connectors See page 321

	2 m cable, bottom	2 m cable, top	2 m cable, back
<b>Contact type</b> <b>L</b> = slow action <b>LO</b> = slow action, make before break			
<b>Contact blocks</b>			
52C <b>L</b>	HP AA052C-2SN → 1NO+1NC	HP AA052C-2AN → 1NO+1NC	HP AA052C-2PN → 1NO+1NC
52D <b>L</b>	HP AA052D-2SN → 2NC	HP AA052D-2AN → 2NC	HP AA052D-2PN → 2NC
52F <b>L</b>	HP AA052F-2SN → 1NO+2NC	HP AA052F-2AN → 1NO+2NC	HP AA052F-2PN → 1NO+2NC
52M <b>L</b>	HP AA052M-2SN → 2NO+2NC	HP AA052M-2AN → 2NO+2NC	HP AA052M-2PN → 2NO+2NC
53C <b>LO</b>	HP AA053C-2SN → 1NO+1NC	HP AA053C-2AN → 1NO+1NC	HP AA053C-2PN → 1NO+1NC
53F <b>LO</b>	HP AA053F-2SN → 1NO+2NC	HP AA053F-2AN → 1NO+2NC	HP AA053F-2PN → 1NO+2NC
53M <b>LO</b>	HP AA053M-2SN → 2NO+2NC	HP AA053M-2AN → 2NO+2NC	HP AA053M-2PN → 2NO+2NC
Actuating force	0.3 Nm (0.65 Nm →)	0.3 Nm (0.65 Nm →)	0.3 Nm (0.65 Nm →)
Travel diagrams	page 58 - group 1	page 58 - group 1	page 58 - group 1

	M12 connector, bottom	M12 connector, top	cable (0.2 m) with M12 connector, back
<b>Contact type</b> <b>L</b> = slow action <b>LO</b> = slow action, make before break			
<b>Contact blocks</b>			
52C <b>L</b>	HP AA052C-KSM → 1NO+1NC	HP AA052C-KAM → 1NO+1NC	HP AA052C-0.2PM → 1NO+1NC
52D <b>L</b>	HP AA052D-KSM → 2NC	HP AA052D-KAM → 2NC	HP AA052D-0.2PM → 2NC
52F <b>L</b>	HP AA052F-KSM → 1NO+2NC	HP AA052F-KAM → 1NO+2NC	HP AA052F-0.2PM → 1NO+2NC
52M <b>L</b>	HP AA052M-KSM → 2NO+2NC	HP AA052M-KAM → 2NO+2NC	HP AA052M-0.2PM → 2NO+2NC
53C <b>LO</b>	HP AA053C-KSM → 1NO+1NC	HP AA053C-KAM → 1NO+1NC	HP AA053C-0.2PM → 1NO+1NC
53F <b>LO</b>	HP AA053F-KSM → 1NO+2NC	HP AA053F-KAM → 1NO+2NC	HP AA053F-0.2PM → 1NO+2NC
53M <b>LO</b>	HP AA053M-KSM → 2NO+2NC	HP AA053M-KAM → 2NO+2NC	HP AA053M-0.2PM → 2NO+2NC
Actuating force	0.3 Nm (0.65 Nm →)	0.3 Nm (0.65 Nm →)	0.3 Nm (0.65 Nm →)
Travel diagrams	page 58 - group 1	page 58 - group 1	page 58 - group 1

**Attention!** The safety hinge switch can be combined together exclusively with one or more Pizzato Elettrica hinges (HP or HC series). The use of whichever other hinge does not guarantee the correct operation of the safety device.





		2 m cable, bottom	2 m cable, top	2 m cable, back			
Contact type							
<b>L</b> = slow action							
<b>LO</b> = slow action, make before break							
Contact blocks							
52C	<b>L</b>	HP AB052C-2SN	⊕ 1NO+1NC	HP AB052C-2AN	⊕ 1NO+1NC	HP AB052C-2PN	⊕ 1NO+1NC
52D	<b>L</b>	HP AB052D-2SN	⊕ 2NC	HP AB052D-2AN	⊕ 2NC	HP AB052D-2PN	⊕ 2NC
52F	<b>L</b>	HP AB052F-2SN	⊕ 1NO+2NC	HP AB052F-2AN	⊕ 1NO+2NC	HP AB052F-2PN	⊕ 1NO+2NC
52M	<b>L</b>	HP AB052M-2SN	⊕ 2NO+2NC	HP AB052M-2AN	⊕ 2NO+2NC	HP AB052M-2PN	⊕ 2NO+2NC
53C	<b>LO</b>	HP AB053C-2SN	⊕ 1NO+1NC	HP AB053C-2AN	⊕ 1NO+1NC	HP AB053C-2PN	⊕ 1NO+1NC
53F	<b>LO</b>	HP AB053F-2SN	⊕ 1NO+2NC	HP AB053F-2AN	⊕ 1NO+2NC	HP AB053F-2PN	⊕ 1NO+2NC
53M	<b>LO</b>	HP AB053M-2SN	⊕ 2NO+2NC	HP AB053M-2AN	⊕ 2NO+2NC	HP AB053M-2PN	⊕ 2NO+2NC
Actuating force		0.3 Nm (0.65 Nm ⊕)		0.3 Nm (0.65 Nm ⊕)		0.3 Nm (0.65 Nm ⊕)	
Travel diagrams		page 58 - group 1		page 58 - group 1		page 58 - group 1	

		M12 connector, bottom	M12 connector, top	cable (0.2 m) with M12 connector, back			
Contact type							
<b>L</b> = slow action							
<b>LO</b> = slow action, make before break							
Contact blocks							
52C	<b>L</b>	HP AB052C-KSM	⊕ 1NO+1NC	HP AB052C-KAM	⊕ 1NO+1NC	HP AB052C-0.2PM	⊕ 1NO+1NC
52D	<b>L</b>	HP AB052D-KSM	⊕ 2NC	HP AB052D-KAM	⊕ 2NC	HP AB052D-0.2PM	⊕ 2NC
52F	<b>L</b>	HP AB052F-KSM	⊕ 1NO+2NC	HP AB052F-KAM	⊕ 1NO+2NC	HP AB052F-0.2PM	⊕ 1NO+2NC
52M	<b>L</b>	HP AB052M-KSM	⊕ 2NO+2NC	HP AB052M-KAM	⊕ 2NO+2NC	HP AB052M-0.2PM	⊕ 2NO+2NC
53C	<b>LO</b>	HP AB053C-KSM	⊕ 1NO+1NC	HP AB053C-KAM	⊕ 1NO+1NC	HP AB053C-0.2PM	⊕ 1NO+1NC
53F	<b>LO</b>	HP AB053F-KSM	⊕ 1NO+2NC	HP AB053F-KAM	⊕ 1NO+2NC	HP AB053F-0.2PM	⊕ 1NO+2NC
53M	<b>LO</b>	HP AB053M-KSM	⊕ 2NO+2NC	HP AB053M-KAM	⊕ 2NO+2NC	HP AB053M-0.2PM	⊕ 2NO+2NC
Actuating force		0.3 Nm (0.65 Nm ⊕)		0.3 Nm (0.65 Nm ⊕)		0.3 Nm (0.65 Nm ⊕)	
Travel diagrams		page 58 - group 1		page 58 - group 1		page 58 - group 1	

**Attention!** The safety hinge switch can be combined together exclusively with one or more Pizzato Elettrica hinges (HP or HC series). The use of whichever other hinge does not guarantee the correct operation of the safety device.

Additional hinges

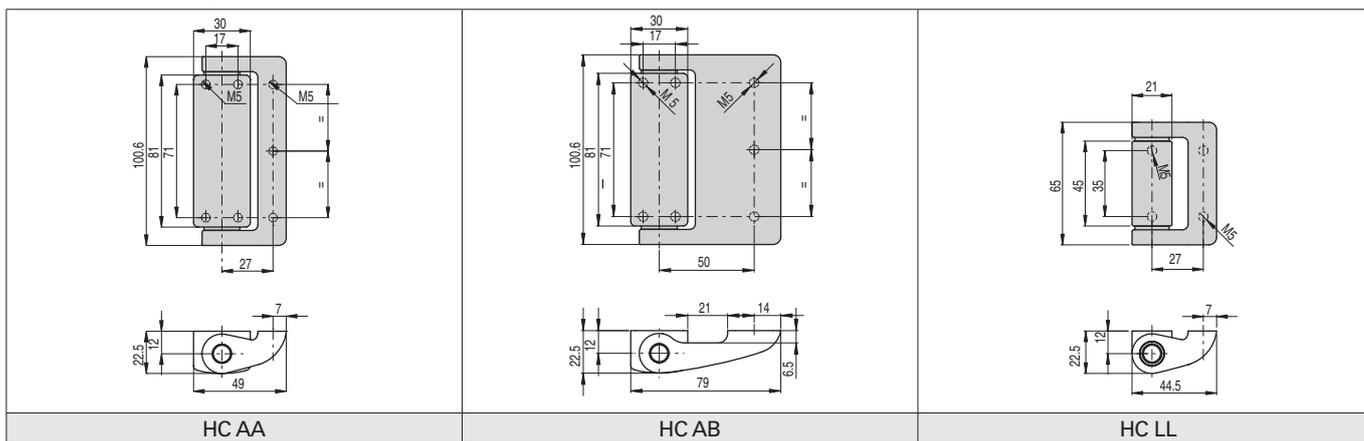

Maximum forces and loads HP AA•••••, HC AA, HC LL

Admitted max. loads, independent of utilization conditions.

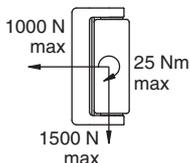

Attention: Never exceed the loads listed above under any circumstances.

The loads have been verified by a fatigue test of one million operating cycles with a 90° opening angle.

Legend

- $F_{max}$  Force exerted by the weight of the door (N)
- D Distance from the centre of gravity of the door to the axis of the hinge (mm)
- A Safety hinge
- B Additional hinge

Doors with one safety hinge  
 $F_{max}(N)=25,000/D$  (mm)

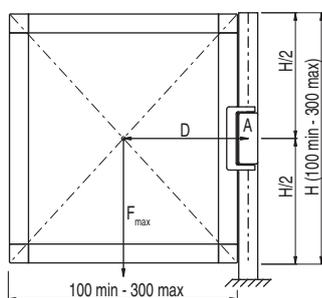

Doors with one safety hinge and one additional hinge  
 $F_{max}(N)=200,000/D$  (mm)

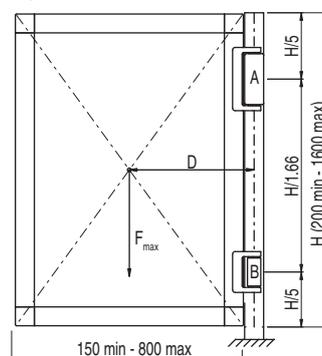

Doors with one safety hinge and two additional hinges  
 $F_{max}(N)=250,000/D$  (mm)

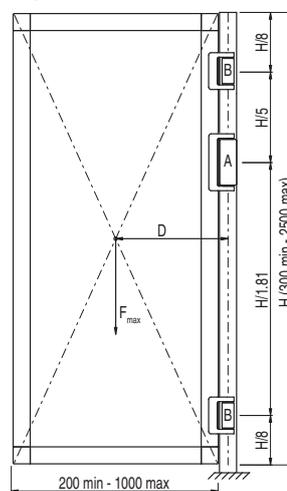

Maximum forces and loads HP AB•••••, HC AB

Admitted max. loads, independent of utilization conditions.

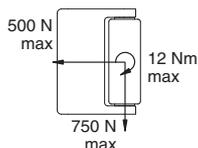

Attention: Never exceed the loads listed above under any circumstances.

The loads have been verified by a fatigue test of one million operating cycles with a 90° opening angle.

Legend

- $F_{max}$  Force exerted by the weight of the door (N)
- D Distance from the centre of gravity of the door to the axis of the hinge (mm)
- A Safety hinge
- B Additional hinge

Doors with one safety hinge  
 $F_{max}(N)=12,500/D$  (mm)

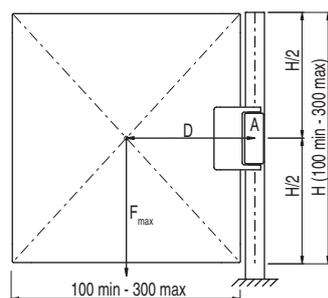

Doors with one safety hinge and one additional hinge  
 $F_{max}(N)=100,000/D$  (mm)

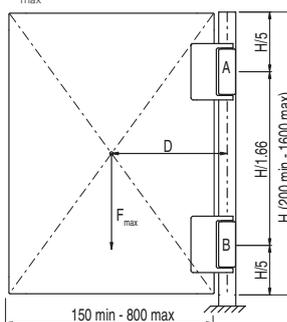

Doors with one safety hinge and two additional hinges  
 $F_{max}(N)=200,000/D$  (mm)

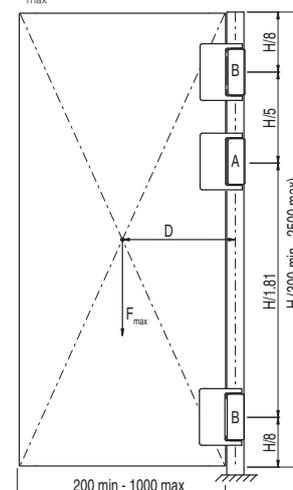

Accessories

Article	Description
VF AC7032	Protection cap for adjustment screw



The cap is supplied with every hinge and must always be inserted after the adjustment of the switching point.

In case of loss or damage, the cap can be ordered separately.

All values in the drawings are in mm

Accessories See page 321

→ The 2D and 3D files are available at [www.pizzato.com](http://www.pizzato.com)



## Description



The HX series hinge switches from Pizzato Elettrica combine safety and style in a single product.

The electric switch is fully integrated into the mechanical hinge so that it is virtually invisible to an inexperienced eye. This, besides being an aesthetic advantage, guarantees greater safety as a switch which is difficult to identify is consequently even more difficult to tamper with. The rear mounting without screws in sight and the very precise line mean the switch can be perfectly integrated even with guards of machinery with a very precise design.

As the HX series safety hinge switches are in stainless steel, they can be used in environments where particular attention must be paid to hygiene making them suitable for a variety of applications, ranging from the food and pharmaceutical sectors to the chemical and marine sectors.

## Maximum safety with a single device

# PL e + SIL 3

The HX BEE1 series hinge switches are constructed with redundant electronics. As a result, the maximum PL e and SIL 3, safety levels can still be achieved through the use of a single device on a guard. This avoids expensive wiring in the field and allows faster installation. Inside the control cabinet, the two electronic safety outputs must be connected to a safety module with OSSD inputs or to a safety PLC.

## Series connection of several switches

# PL e + SIL 3

One of the most important features of the HX series is the possibility of connecting up to 32 sensors in series, while still maintaining the maximum safety levels PL e laid down in EN 13849-1 and SIL 3 acc. to EN 62061.

This connection type is permissible in safety systems which have a safety module at the end of the chain that monitors the outputs of the last HX switch.

The fact that the PL e safety level can be maintained even with 32 sensors connected in series demonstrates the extremely secure structure of each single device.

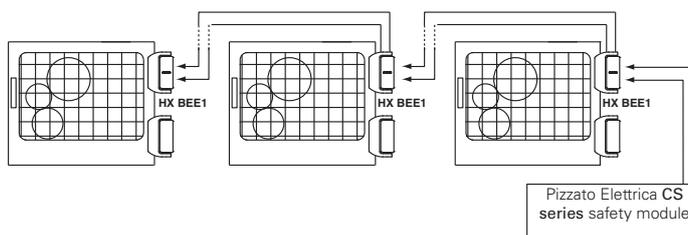

## Series connection with other devices

# PL e + SIL 3

The HX BEE1 series hinge switch features two safety inputs and two safety outputs, which can be connected in series with other Pizzato Elettrica safety devices. This option allows the creation of safety chains containing various devices. For example, stainless steel safety hinges (HX BEE1 series), transponder sensors (ST series) and door lock sensors (NG series) can be connected in series while still maintaining the maximum PL e and SIL 3 safety levels.

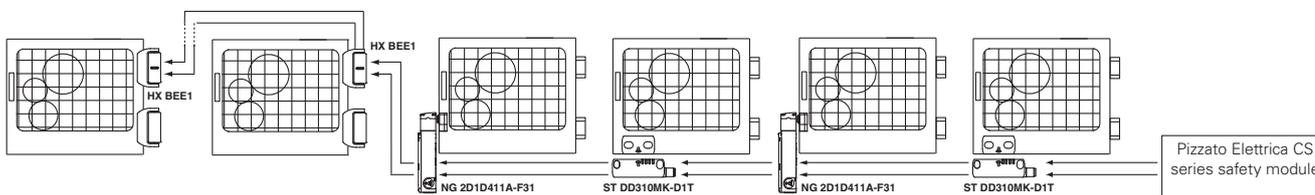

## Adjustment of the switching point

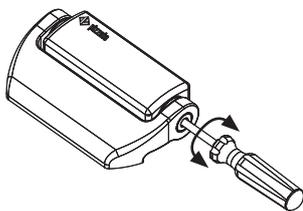

The switching point of the switches can be set with a flat-blade screwdriver.

Adjusting the switching point allows for any calibration for large size guards. After calibrating the switch, it is always necessary to close the hole using the safety cap supplied.

## Basic activation angle variants

On request, versions with a switch base activation angle of 15° multiples (e.g. 45° or 90°) are available.

The different activation angle does not exclude the possibility of fine adjustment of the switching point by means of the adjustment screw in the switch. Any change in the base operating angle does not alter the maximum mechanical switch travel.

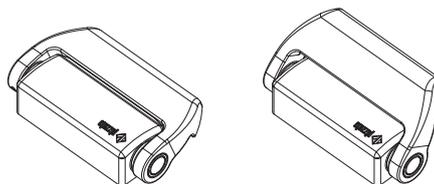

## Cable with connector at the back

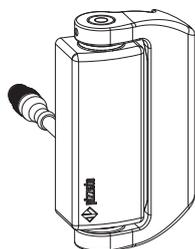

The version with a cable with M12 connector at the back offers the best combination of aesthetics and simple connection.

This solution allows the wiring to be hidden. At the same time, it facilitates the connection and disconnection of the wiring from inside the machinery.

## Opening angle up to 180°

The mechanical design of the switch also allows use on guards with an opening angle of up to 180°.

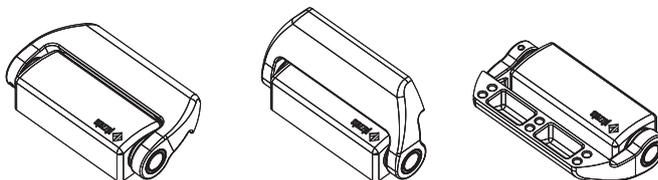



### Protection degrees IP67 and IP69K

# IP69K IP67

These devices are designed to be used in the toughest environmental conditions and they pass the IP67 immersion test acc. to EN 60529. They can therefore be used in all environments where maximum protection degree of the housing is required. Due to

their special design, these devices are suitable for use in equipment subjected to cleaning with high pressure hot water jets. These devices meet the IP69K test requirements according to ISO 20653 (water jets with 100 bar and 80°C).

### Materials

# AISI 316L

With this new series in AISI316L stainless steel, Pizzato Elettrica offers an extensive range of devices suitable for environments where special attention must be paid to cleanliness and hygiene.

The accurate surface finish allows these devices to be used for a variety of applications, ranging from the food and pharmaceutical sectors to the chemical and marine sectors.

### For heavy duty applications

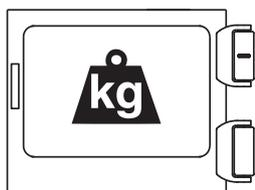

Specially designed for heavy industrial applications, these hinges are made of high-thickness microfusion materials with high strength mechanical properties. The maximum loads indicated in the technical specifications are those that the hinge can withstand without any lubrication, for one million opening and closing cycles,

while maintaining its features as a safety device in perfect efficiency.

### With cable or connector

The electrical connection via integrated cable or M12 connector option makes the device suitable for the most diverse applications. The connector versions allow faster device replacement and installation, by making incorrect wiring connection impossible. The cable versions, on the other hand, offer the best value for money. Both the cable as well as the connector versions are available with mechanical or electronic contact blocks.

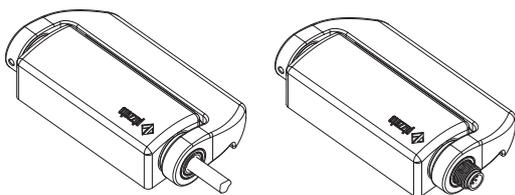

### Three different output directions

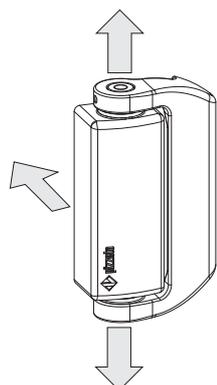

Designed for flexibility, the HX series safety hinges are equipped with three different output directions for the electrical conductors. Directions from below or from above allow the same exit direction of the conductor to be maintained, both for right and for left-hand doors. The direction from behind has the ultimate aesthetic, cleanliness and hygiene result. All three electrical output directions are available with output cables in various lengths or with M12 connector.

### Additional hinges

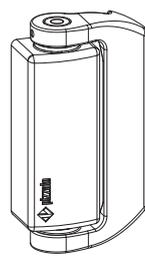

To complete the installation, various types of additional hinges are available to be used in a variable number depending on the weight of the guard.

These hinges have the same aesthetic and mechanical structure but cost less as they contain no electrical parts.

### Laser engraving



Pizzato Elettrica has introduced a new laser engraving system for stainless steel switches of the HX series.

Thanks to this new system, engravings on the products are indelible.

### Mechanical or electronic contact blocks

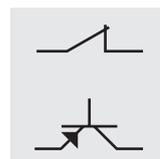

Internally equipped with innovative concepts, the HX series safety switches can be supplied both with electromechanical safety contacts with positive opening, or with self monitoring redundant electronic safety outputs. This allows the customer to choose between the most cost-effective solution (mechanical contacts) or a maximum security solution (electronic outputs).

### Four LEDs for immediate diagnosis



The versions with electronic contact block are equipped with four signalling LEDs. Each LED represents a specific hinge function, this greatly facilitates switching point adjustment via the immediate visual indication for the installer during the adjustment phase. There are also three separate LEDs available: one for input status, one for output status, and one for general device status. For serial applications,

this independence enables identification of any interruptions in the safety chain and of any internal errors. All of this at a glance, without needing to decode complex flashing sequences.

### Gold-plated contacts

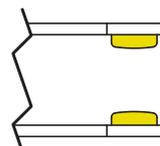

The contact blocks of these devices can be supplied gold-plated upon request. Ideal for applications with low voltages or currents; it ensures increased contact reliability. The high-thickness coating > 1 micron ensures the mechanical endurance of the coating over time.

Selection diagram

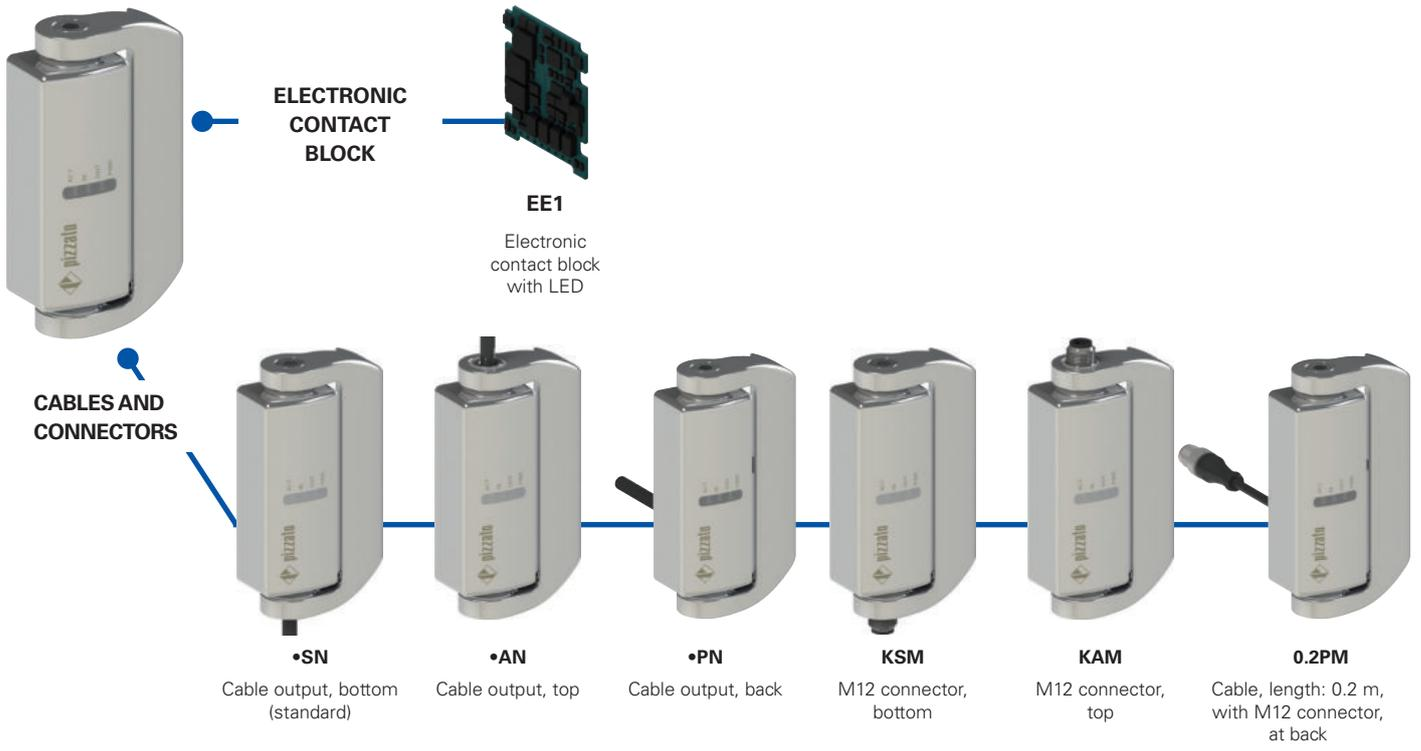
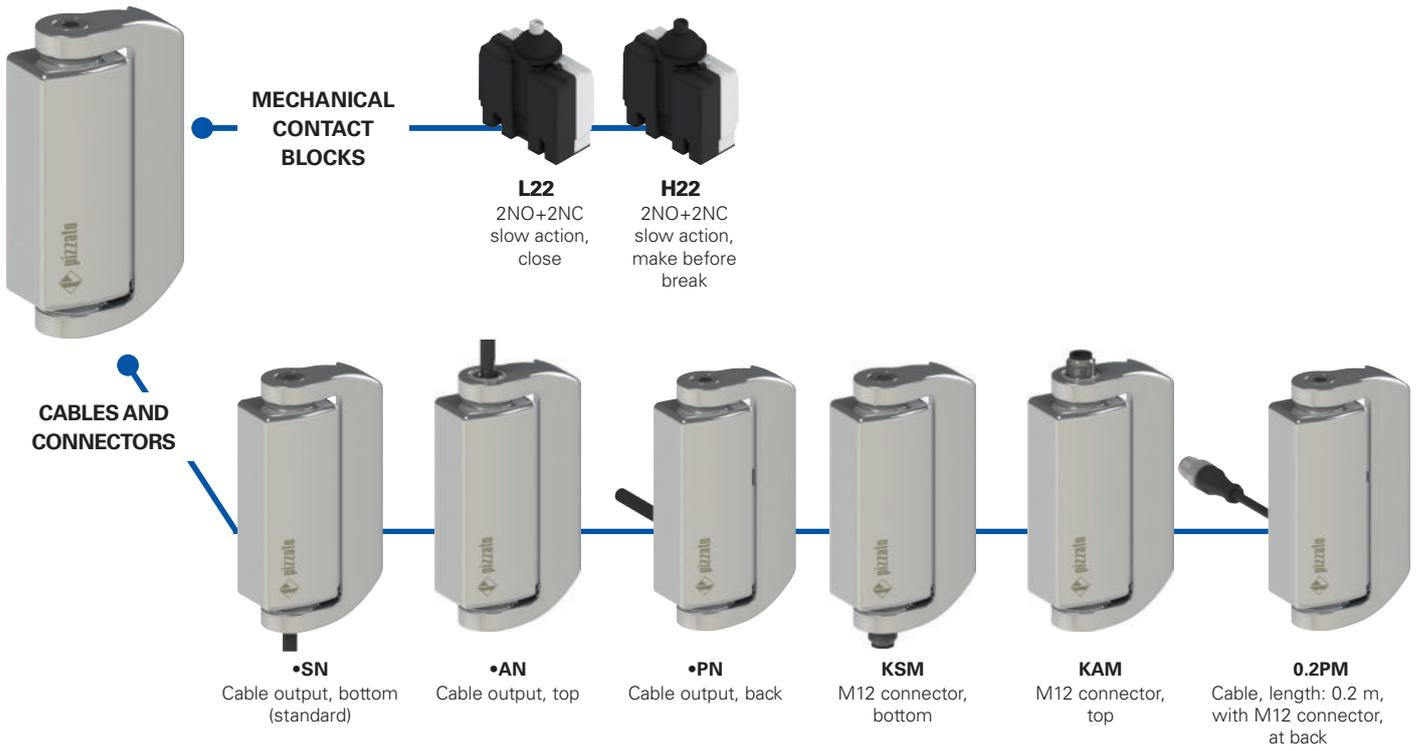

ADDITIONAL HINGES



HX CB

HX CD

—●— product option

**Code structure****Attention!** The feasibility of a code number does not mean the effective availability of a product. Please contact our sales office.

article	options
<b>HX BL22-2PN</b>	<b>GH15</b>

Body and movable part dimensions	
<b>B</b>	126x76x31 mm

Contact blocks	
<b>L22</b>	2NO+2NC, slow action, close
<b>H22</b>	2NO+2NC, slow action, make before break
<b>EE1</b>	electronic contact block with LED 2 PNP safety outputs 1 PNP signalling output 2 PNP safety inputs

Connection type	
<b>0.2</b>	cable, length: 0.2 m (available for 0.2 PM versions only)
<b>0.5</b>	cable, length: 0.5 m
...	.....
<b>2</b>	cable, length: 2 m (standard)
...	.....
<b>10</b>	cable, length: 10 m
<b>K</b>	with integrated connector

Other cable lengths on request.

Activation angle	
	0° activation angle (standard)
<b>H15</b>	15° activation angle
<b>H30</b>	30° activation angle
<b>H45</b>	45° activation angle
<b>H60</b>	60° activation angle
<b>H75</b>	75° activation angle
<b>H90</b>	90° activation angle

Contact type	
	silver contacts (standard)
<b>G</b>	silver contacts with 1 µm gold coating

Cable or connector type	
<b>N</b>	PVC cable, IEC 60332-1-2 oil-resistant
<b>M</b>	cable with M12 connector

Output direction, connections	
<b>S</b>	movable part at the right and bottom output
<b>P</b>	movable part at the right and output at the back
<b>A</b>	movable part at the right and output at top
<b>Q</b>	movable part at the left and output at the back (on request)

**Code structure for additional hinges****HX CB**

Additional hinges	
<b>CB</b>	126x76x31 mm, movable part at the right
<b>CD</b>	126x76x31 mm, movable part at the left



#### Main features

- AISI 316L stainless steel housing
- Protection degrees IP67 and IP69K
- Electronic contact block with LED
- Versions with M12 connector
- Additional hinge without contacts

#### Compliance with the requirements of:

Machinery Directive 2006/42/EC,  
EMC Directive 2014/30/EU,  
RoHS Directive 2011/65/EU.

#### Positive contact opening in conformity with standards:

IEC 60947-5-1, EN 60947-5-1.

#### In compliance with standards:

IEC 60947-5-1, EN 60947-5-1, EN 60947-1,  
IEC 60204-1, EN 60204-1, EN ISO 14119,  
EN ISO 12100, IEC 60529, EN 60529,  
ISO 20653, IEC 61508-1, IEC 61508-2,  
IEC 61508-3, EN ISO 13849-1, EN ISO 13849-2,  
EN 62061, EN 61326-1, EN 61326-3-1,  
EN 61326-3-2, EN 50581, UL 508,  
CSA 22.2 No.14

#### Quality marks:



UL approval: E131787  
TÜV SÜD approval: Z10 14 03 75157 007  
EAC approval: RU C-IT.YT03.B.00035/19

#### Technical data

##### Housing

Metal housing, polished, AISI 316L stainless steel  
Versions with integrated cable, length 2 m, other lengths from 0.5 ... 10 m on request  
Versions with integrated M12 connector  
Versions with M12 connector and 0.2 m cable, other lengths from 0.1 ... 3 m on request  
Protection degree:

IP67 acc. to EN 60529  
IP69K acc. to ISO 20653  
(Protect the cables from direct high-pressure and high-temperature jets)

Corrosion resistance in saline mist:  $\geq 1000$  hours in NSS acc. to ISO 9227

##### General data

SIL (SIL CL) up to: SIL CL 3 acc. to EN 62061  
Performance Level (PL) up to: PL e acc. to EN ISO 13849-1  
Mechanical interlock, not coded: type 1 acc. to EN ISO 14119  
Safety parameters HX B•22-•••  
B<sub>10D</sub>: 5,000,000 for NC contacts  
Safety parameters HX BEE1-•••  
MTTF<sub>D</sub>: 2413 years  
PFH<sub>D</sub>: 1.24E-09  
DC: High  
Mission time: 20 years  
Ambient temperature: see table on page 64  
Max. actuation frequency: 600 operating cycles/hour  
Mechanical endurance: 1 million operating cycles  
Max. actuation speed: 90°/s  
Min. actuation speed: 2°/s  
Mounting position: any  
Tightening torque, M6 screws: 10 ... 12 Nm

##### Electrical data (L22 - H22 mechanical contact blocks)

Rated impulse withstand voltage U<sub>imp</sub>: 4 kV  
Conditional short circuit current: 1000 A acc. to EN 60947-5-1  
Pollution degree: 3

##### Electrical data (EE1 electronic contact block)

Rated operating voltage U<sub>e</sub>: 24 Vdc -15% ... +10% SELV  
Consumption at voltage U<sub>e</sub>: < 1W  
Rated impulse withstand voltage U<sub>imp</sub>: 1.5 kV  
Resettable internal protection fuse: 1.1 A  
Overvoltage category: III  
IS1/IS2 safety inputs  
Rated operating voltage U<sub>e</sub>: 24 Vdc  
Rated current consumption: 5 mA  
OS1/OS2 safety outputs  
Rated operating voltage U<sub>e</sub>: 24 Vdc  
Output type: PNP type OSSD  
Utilisation category: DC13; U<sub>e</sub>=24 Vdc; I<sub>e</sub>=0.25 A  
Short circuit detection: Yes  
Overcurrent protection: Yes  
Duration of the deactivation impulses at the safety outputs: < 300 us  
Permissible capacitance between outputs: < 200 nF  
Permissible capacitance between output and ground: < 200 nF  
O3 signalling output  
Rated operating voltage U<sub>e</sub>: 24 Vdc  
Output type: PNP  
Utilisation category: DC13; U<sub>e</sub>=24 Vdc; I<sub>e</sub>=0.1 A  
Short circuit detection: No  
Overcurrent protection: Yes

**⚠ If not expressly indicated in this chapter, for correct installation and utilization of all articles see the instructions given on pages 337 to 350.**

**⚠ Important: Switch off the circuit voltage before disconnecting the connector from the switch. The connector is not suitable for separation of electrical loads. According to EN 60204-1, versions with 8-pole M12 connector can be used only in SELV circuits.**

#### Features approved by UL

Electrical Ratings: R300 pilot duty (28 VA, 125-250 Vdc)  
C300 pilot duty (180 VA, 120-240 Vac)  
24 Vdc / 0.25 A (electronic version)  
Environmental Ratings: Types 1, 4X, 6, 12, 13

#### Features approved by TÜV SÜD

Supply voltage: 24 Vdc  
Rated operating current (max.): 0.25 A  
Ambient temperature: -25°C ... +70°C  
Protection degree: IP67 and IP69K  
PL, category: PL e, category 4

In compliance with standards: IEC 61508-1:2010 (SIL 3), IEC 61508-2:2010 (SIL 3), IEC 61508-3:2010 (SIL 3), IEC 61508-4:2010 (SIL 3), IEC 62061:2005/A2:2015 (SIL CL 3), EN ISO 13849-1:2015 (PL e, Cat. 4), EN 60947-5-1:2017, ISO 14119:2013

Please contact our technical department for the list of approved products.

Please contact our technical department for the list of approved products.





### Utilization temperatures and electrical data for L22/H22 mechanical contact blocks

		N type cable 9 x 0.34 mm <sup>2</sup>	M12 connector, 8-pole	
Ambient temperature	Cable, fixed installation	-25°C ... +80°C	-25°C ... +80°C	
	Cable, flexible installation	-5°C ... +80°C	-5°C ... +80°C	
	Cable, mobile installation	/	/	
Electrical data	Thermal current I <sub>th</sub>	3 A	2 A	
	Rated insulation voltage U <sub>i</sub>	250 Vac	30 Vac 36 Vdc	
	Protection against short circuits (fuse)	3 A 500 V type gG	2 A 500V type gG	
	Utilization category DC13	24 V	2 A	2 A
		125 V	0.4 A	/
		250 V	0.3 A	/
	Utilization category AC15	24 V	3 A	2 A
		120 V	3 A	/
		250 V	3 A	/
Approvals	CE cULus TÜV EAC	CE cULus TÜV EAC		

### Utilization temperatures and electrical data for EE1 electronic contact block

		N type cable 8 x 0.34 mm <sup>2</sup>	M12 connector, 8-pole	
Ambient temperature	Cable, fixed installation	-25°C ... +70°C	-25°C ... +70°C	
	Cable, flexible installation	-5°C ... +70°C	-5°C ... +70°C	
	Cable, mobile installation	/	/	
Electrical data	Thermal current I <sub>th</sub>	0.25 A	0.25 A	
	Rated insulation voltage U <sub>i</sub>	32 Vdc	32 Vdc	
	Protection against short circuits (fuse)	1 A	1 A	
	Utilization category DC13	24 V	0.25 A	0.25 A
	Approvals	CE cULus TÜV EAC	CE cULus TÜV EAC	

## Internal device connections

### Mechanical contact blocks (HX B•22-•••)

Contacts	Versions with cable	Versions with M12 connector
NC	black	1
	black-white	2
NC	red	3
	red-white	4
NO	brown	5
	blue	6
NO	purple	7
	purple-white	8
⏚	yellow/green	/

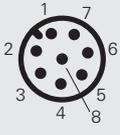

**Legend:**  
 NC normally closed contact  
 NO normally open contact  
 ⏚ ground connection

### Electronic contact blocks (HX BEE1-•••)

Connection	Versions with cable	Versions with M12 connector
A1	brown	1
IS1	red	2
A2	blue	3
OS1	red-white	4
O3	black	5
IS2	purple	6
OS2	black-white	7
not connected	purple-white	8

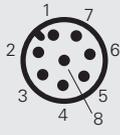

**Legend:**  
 A1-A2 supply  
 IS1-IS2 safety inputs  
 OS1-OS2 safety outputs  
 O3 signalling output

# HX series safety hinge switches

Contact type		2 m cable, bottom	2 m cable, top	2 m cable, back			
<b>LA</b>	= slow action close						
<b>LO</b>	= slow action, make before break						
<b>EE1</b>	= electronic, PNP						
Contact blocks							
L22	<b>LA</b>	HX BL22-2SN	2NO+2NC	HX BL22-2AN	2NO+2NC	HX BL22-2PN	2NO+2NC
H22	<b>LO</b>	HX BH22-2SN	2NO+2NC	HX BH22-2AN	2NO+2NC	HX BH22-2PN	2NO+2NC
EE1	<b>EE1</b>	HX BEE1-2SN	PNP	HX BEE1-2AN	PNP	HX BEE1-2PN	PNP
Actuating force		0.3 Nm (0.65 Nm)		0.3 Nm (0.65 Nm)		0.3 Nm (0.65 Nm)	

Contact type		M12 connector, bottom	M12 connector, top	cable (0.2 m) with M12 connector, back	
<b>LA</b>	= slow action close				
<b>LO</b>	= slow action, make before break				
<b>EE1</b>	= electronic, PNP				
Contact blocks					
L22	<b>LA</b>	HX BL22-KSM	2NO+2NC	HX BL22-0.2PM	2NO+2NC
H22	<b>LO</b>	HX BH22-KSM	2NO+2NC	HX BH22-0.2PM	2NO+2NC
EE1	<b>EE1</b>	HX BEE1-KSM	PNP	HX BEE1-0.2PM	PNP
Actuating force		0.3 Nm (0.65 Nm)		0.3 Nm (0.65 Nm)	

To order a product with a movable part at the left replace P with Q in the codes shown above.  
 Example: HX BL22-2PN → HX BL22-2QN

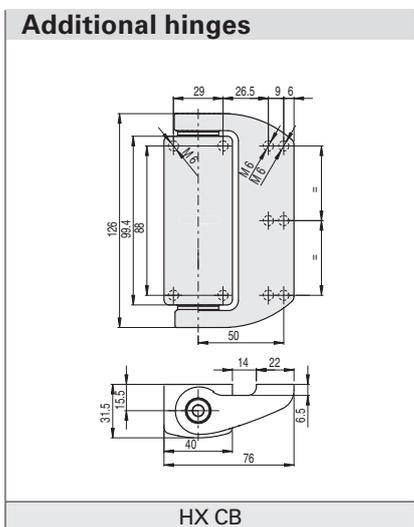

## Travel diagrams

Contact blocks	Group 1
L22 2NO+2NC	
H22 2NO+2NC	
EE1 PNP	

The switching point of the contacts can be adjusted ± 1° compared to that indicated in the travel diagrams.  
 The hinge is supplied without pre-adjustment.

### Legend

- Closed contact /Outputs OS1, OS2, O3 active
- Open contact /Outputs OS1, OS2, O3 not active
- Positive opening travel

All values in the drawings are in mm

Accessories See page 321

→ The 2D and 3D files are available at [www.pizzato.com](http://www.pizzato.com)



### Complete safety system

The use of complete and tested solutions guarantees the electrical compatibility between the hinge of the HX series and the safety modules from Pizzato Elettrica, as well as high reliability. The sensors have been tested with the modules listed in the adjacent table.

Switch	Compatible safety modules	Safety module output contacts		
		Instantaneous safety contacts	Delayed safety contacts	Signalling contacts
HX BEE1-•••	CS AR-05••••	3NO	/	1NC
	CS AR-06••••	3NO	/	1NC
	CS AR-08••••	2NO	/	/
	CS AT-0•••••	2NO	2NO	1NC
	CS AT-1•••••	3NO	2NO	/
	CS MP••••••	see page 277		
CS MF••••••	see page 305			

The hinges with HX BEE1-••• electronic contact block can be connected to safety modules or safety PLCs with OSSD inputs provided compatibility is ensured in advance.

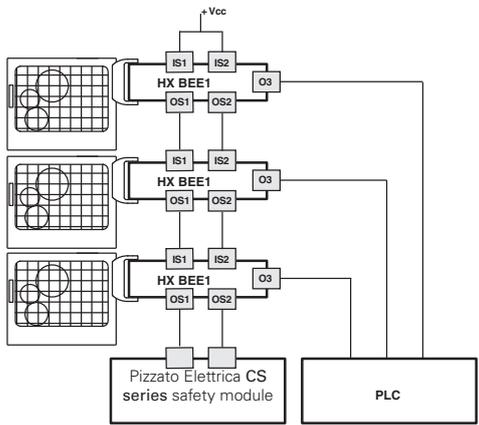

Possibility of series connection of multiple hinges for simplifying the wiring of the safety system, whereby only the outputs of the last hinge are evaluated by a Pizzato Elettrica safety module (see table with compatible safety modules). Each HX switch is provided with a signalling output, which is activated when the respective guard is closed. Depending on the specific requirements of the application, this information can be evaluated by a PLC.

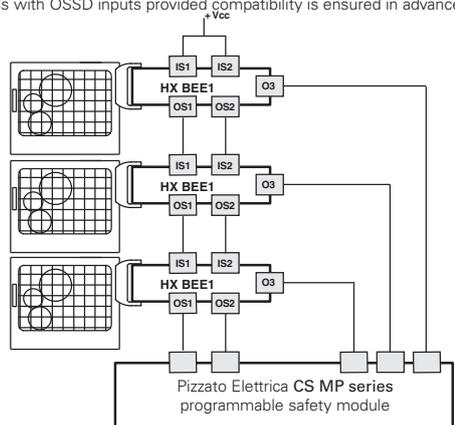

Possibility of series connection of multiple hinges for simplifying the wiring of the safety system, whereby only the outputs of the last hinge are evaluated by a Pizzato Elettrica safety module of the CS MP series. Both the safety-relevant evaluation and the evaluation of the signalling outputs are performed by the CS MP series.

### Internal block diagram

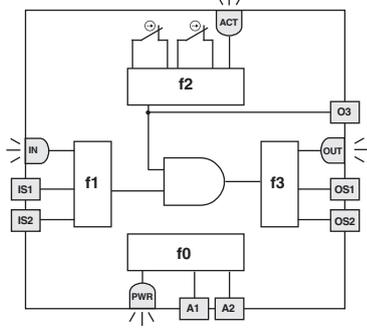

The adjacent diagram illustrates 4 logical, linked sub-functions of the hinge switch.

Function f0 is a basic function and includes the monitoring of the power supply as well as internal, cyclical tests.

The task of function f1 is to evaluate the status of the device inputs, whereas function f2 checks the opening of the guard. Function f3 is intended to activate or deactivate the safety outputs and check for any faults or short circuits in the outputs.

The safety-related function, which combines the sub-functions mentioned above, only activates the safety outputs if the input signals are correctly applied and the guard is in closed position.

The status of each function is displayed by the corresponding LED (PWR, IN, ACT, LOCK, OUT), in such a way that the general device status becomes immediately obvious to the operator.

LED	Function
ACT	state of actuator / O3 output
IN	status of safety inputs
OUT	status of safety outputs
PWR	Power supply/self-diagnosis

### Series connection

To simplify series connections of the devices, various M12 connectors are available that allow complete wiring.

This solution significantly reduces installation times while at the same time maintaining the maximum safety levels PL e and SIL 3.

For further information see page 326.

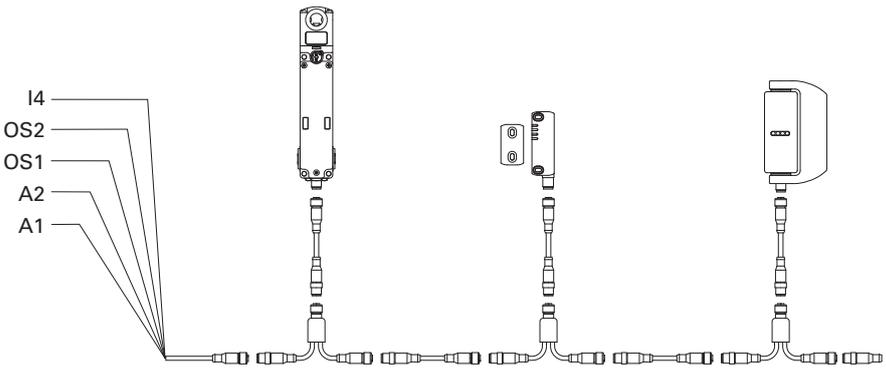

## Accessories

Article	Description
VF AC7032	Protection cap of adjustment screw



The cap is supplied with every hinge and must always be attached after the fine adjustment of the switching point.

In case of loss or damage, the cap can be ordered separately.

## Fixing plates

Article	Description
VF SFH10-TX	Couple of stainless steel plane plates supplied with fastening screws for attachment of the switch

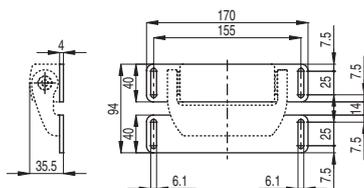
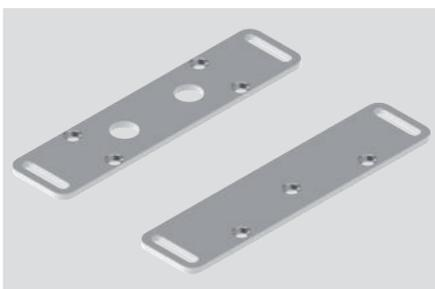

Article	Description
VF SFH9	Polyethylene gaskets for the food industry. Seals the contact surface between the hinge and the frame.

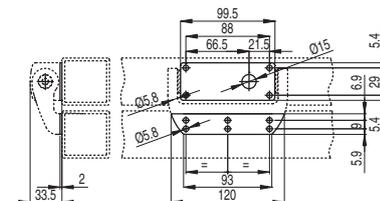

Article	Description
VF SFH8	Mobile part cover in stainless steel. Ideal for fixing the mobile part with polycarbonate guards.

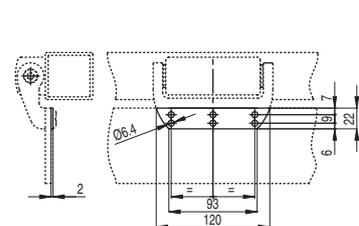
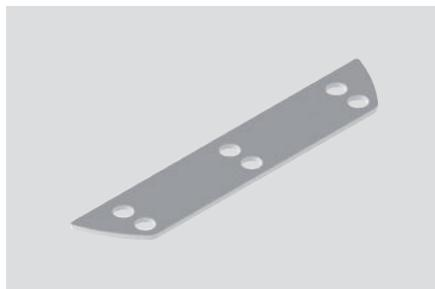

## Max. forces and loads HX

Admitted max. loads, independent of utilization conditions.

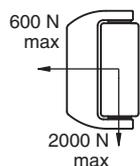

**Attention:** Never exceed the loads listed above under any circumstances.

The loads have been verified by a fatigue test of one million operating cycles with a 90° opening angle.

Doors with one safety hinge  
 $F_{max} (N) = 50,000/D$  (mm)

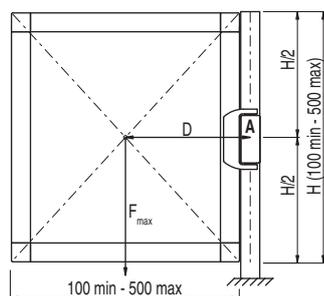

Doors with one safety hinge and one additional hinge  
 $F_{max} (N) = 400,000/D$  (mm)

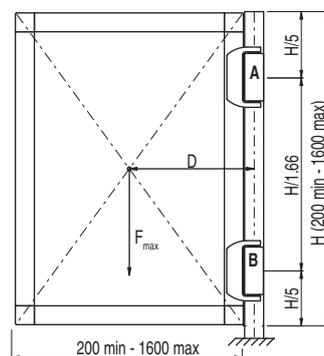

Doors with one safety hinge and two additional hinges  
 $F_{max} (N) = 500,000/D$  (mm)

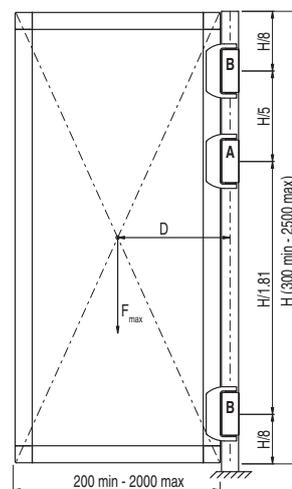

## Legend

$F_{max}$	Force exerted by the weight of the door (N)
D	Distance from the centre of gravity of the door to the axis of the hinge (mm)
A	Safety hinge
B	Additional hinge



## Selection diagram

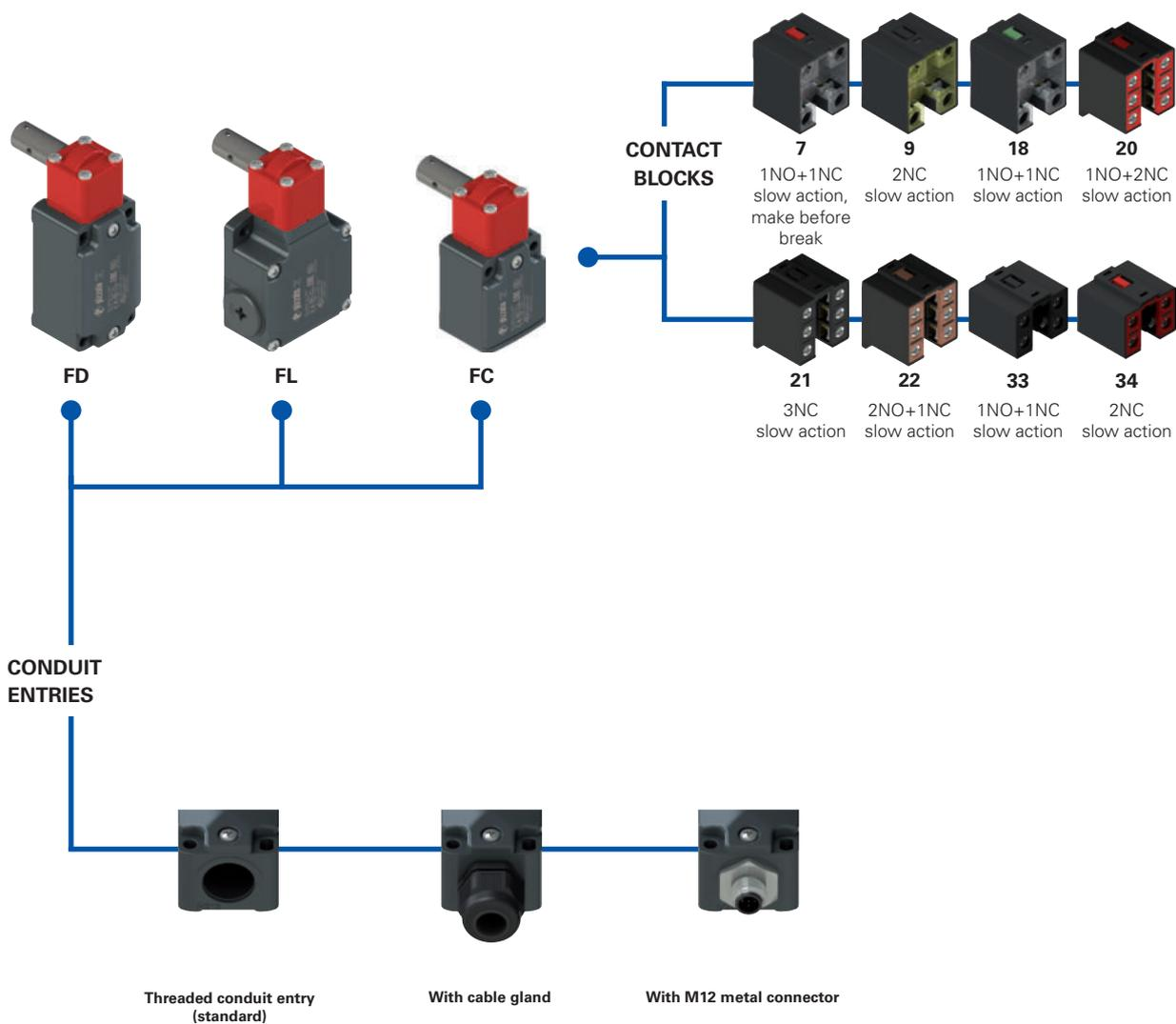

—●— product options



**Code structure** **Attention!** The feasibility of a code number does not mean the effective availability of a product. Please contact our sales office.

article options options  
**FD 1895-GM2K50T6**

Housing	
<b>FD</b>	metal, one conduit entry
<b>FL</b>	metal, three conduit entries

Ambient temperature	
	-25°C ... +80°C (standard)
<b>T6</b>	-40°C ... +80°C

Contact blocks	
<b>7</b>	1NO+1NC, slow action, make before break
<b>9</b>	2NC, slow action
<b>18</b>	1NO+1NC, slow action
<b>20</b>	1NO+2NC, slow action
<b>21</b>	3NC, slow action
<b>22</b>	2NO+1NC, slow action
<b>33</b>	1NO+1NC, slow action
<b>34</b>	2NC, slow action

Pre-installed cable glands or connectors	
	no cable gland or connector (standard)
<b>K23</b>	cable gland for cables Ø 6 ... 12 mm
...	.....
<b>K50</b>	M12 metal connector, 5-pole
...	.....

For the complete list of possible combinations please contact our technical department.

Contact type	
	silver contacts (standard)
<b>G</b>	silver contacts with 1 µm gold coating
<b>G1</b>	silver contacts, 2.5 µm gold coating (not for contact blocks 20, 21, 22, 33, 34)

Threaded conduit entry	
<b>M2</b>	M20x1.5 (standard)
	PG 13.5

article options options  
**FC 3395-GM2K50T6**

Housing	
<b>FC</b>	metal, one conduit entry

Ambient temperature	
	-25°C ... +80°C (standard)
<b>T6</b>	-40°C ... +80°C

Contact blocks	
<b>33</b>	1NO+1NC, slow action
<b>34</b>	2NC, slow action

Pre-installed cable glands or connectors	
	no cable gland (standard)
<b>K23</b>	cable gland for cables Ø 6 ... 12 mm
<b>K50</b>	M12 metal connector, 5-pole

Contact type	
	silver contacts (standard)
<b>G</b>	silver contacts with 1 µm gold coating

Threaded conduit entry	
<b>M2</b>	M20x1.5 (standard)
	PG 11

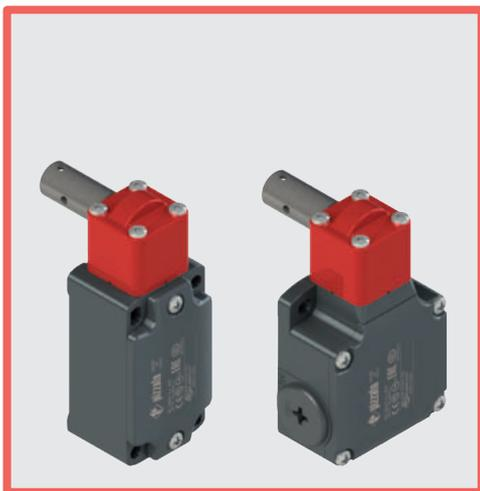

### Main features

- Metal housing, from one to three conduit entries
- Protection degree IP67
- 8 contact blocks available
- Stainless steel actuator
- Versions with M12 connector
- Versions with gold-plated silver contacts

### Quality marks:



IMQ approval:	EG605
UL approval:	E131787
CCC approval:	2007010305230000
EAC approval:	RU C-IT.YT03.B.00035/19

### Technical data

#### Housing

FD, FL and FC series: metal housing, baked powder coating.	
Stainless steel actuator.	
FD, FC series: one threaded conduit entry:	M20x1.5 (standard)
FL series: three threaded conduit entries:	M20x1.5 (standard)
Protection degree:	IP67 acc. to EN 60529 with cable gland of equal or higher protection degree

#### General data

SIL (SIL CL) up to:	SIL 3 acc. to EN 62061
Performance Level (PL) up to:	PL e acc. to EN ISO 13849-1
Mechanical interlock, not coded:	type 1 acc. to EN ISO 14119
Safety parameters:	
$B_{10D}$ :	5,000,00 for NC contacts
Mission time:	20 years
Ambient temperature:	-25°C ... +80°C (standard) -40°C ... +80°C (T6 option)
Max. actuation frequency:	3600 operating cycles/hour
Mechanical endurance:	1 million operating cycles
Max. actuation speed:	180°/s
Min. actuation speed:	2°/s
Tightening torques for installation:	see page 339
Wire cross-sections and wire stripping lengths:	see page 357

#### In compliance with standards:

IEC 60947-5-1, IEC 60947-1, IEC 60204-1, EN ISO 14119, EN ISO 12100, IEC 60529, EN 50581, UL 508, CSA 22.2 No.14.

#### Approvals:

EN 60947-5-1, UL 508, CSA 22.2 No.14, GB/T14048.5-2017.

#### Compliance with the requirements of:

Machinery Directive 2006/42/EC, EMC Directive 2014/30/EU, RoHS Directive 2011/65/EU.

#### Positive contact opening in conformity with standards:

IEC 60947-5-1, EN 60947-5-1.

**⚠ If not expressly indicated in this chapter, for correct installation and utilization of all articles see the instructions given on pages 337 to 350.**

	Electrical data	Utilization category
without connector	Thermal current ( $I_{th}$ ): 10 A Rated insulation voltage ( $U_i$ ): 500 Vac 600 Vdc 400 Vac 500 Vdc (contact blocks 20, 21, 22, 33, 34) Rated impulse withstand voltage ( $U_{imp}$ ): 6 kV 4 kV (contact blocks 20, 21, 22, 33, 34) Conditional short circuit current: 1000 A acc. to EN 60947-5-1 Protection against short circuits: type aM fuse 10 A 500 V Pollution degree: 3	Alternating current: AC15 (50÷60 Hz) $U_e$ (V) 250 400 500 $I_e$ (A) 6 4 1 Direct current: DC13 $U_e$ (V) 24 125 250 $I_e$ (A) 3 0.55 0.3
with M12 connector, 4 or 5-pole	Thermal current ( $I_{th}$ ): 4 A Rated insulation voltage ( $U_i$ ): 250 Vac 300 Vdc Protection against short circuits: type gG fuse 4 A 500 V Pollution degree: 3	Alternating current: AC15 (50÷60 Hz) $U_e$ (V) 24 120 250 $I_e$ (A) 4 4 4 Direct current: DC13 $U_e$ (V) 24 125 250 $I_e$ (A) 3 0.55 0.3
with M12 connector, 8-pole	Thermal current ( $I_{th}$ ): 2 A Rated insulation voltage ( $U_i$ ): 30 Vac 36 Vdc Protection against short circuits: type gG fuse 2 A 500 V Pollution degree: 3	Alternating current: AC15 (50÷60 Hz) $U_e$ (V) 24 $I_e$ (A) 2 Direct current: DC13 $U_e$ (V) 24 $I_e$ (A) 2





## Description



These safety switches are designed to monitor gates or guards that safeguard dangerous parts of machines without inertia. They are very sensitive, open the contacts after few degrees of rotation and immediately send the stop signal. The head, which can be turned in 90° steps, enables installation in multiple positions.

The metal housing and the stainless steel actuator enable use even under operating conditions in which dust and dirt could inhibit the operation of normal safety switches with separate actuator.

## Head with variable orientation

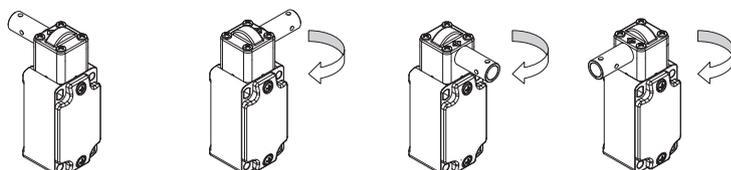

For all switches, the head can be adjusted in 90° steps after removing the four fastening screws. This allows you to use the same switch on both right- and left-facing door fronts.

## Protection degree IP67

**IP67** These devices are designed to be used in the toughest environmental conditions and they pass the IP67 immersion test acc. to EN 60529. They can therefore be used in all environments where maximum protection degree of the housing is required.

## Extended temperature range

**-40°C** These devices are also available in a special version suitable for an ambient operating temperature range from -40°C up to +80°C.

They can therefore be used for applications in cold stores, sterilisers and other equipment with low temperature environments. The special materials used to produce these versions retain their characteristics even under these conditions, thereby expanding the installation possibilities.

## Laser engraving



All devices are marked using a dedicated indelible laser system. These engravings are therefore suitable for extreme environments too. Thanks to this system that does not use labels, the loss of plate data is prevented and a greater resistance of the marking is achieved over time.

## Adjustable switching point



When installing the device, the contact switching point can be adjusted over the entire 360° range. By fixing the stud screw, it is possible to check the correct setting of the activation angle and quickly and easily adjust it if necessary. Once adjustment is complete, you can render the device tamper-proof against commonly used tools using the supplied lock pin.

## Application examples

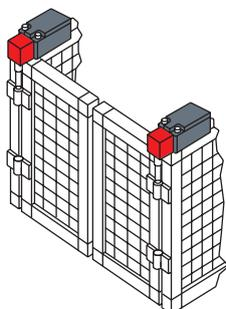

Safety switches for hinges, mounting on double door

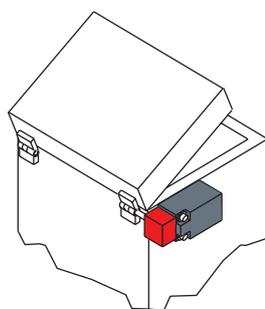

Safety switch for hinges, mounting outside the safety guard

## Features approved by IMQ

Rated insulation voltage (U <sub>i</sub> ):	500 Vac 400 Vac (for contact blocks 20, 21, 22, 33, 34)
Conventional free air thermal current (I <sub>th</sub> ):	10 A
Protection against short circuits:	type aM fuse 10 A 500 V
Rated impulse withstand voltage (U <sub>imp</sub> ):	6 kV 4 kV (for contact blocks 20, 21, 22, 33, 34)
Protection degree of the housing:	IP67
MV terminals (screw terminals)	
Pollution degree:	3
Utilization category:	AC15
Operating voltage (U <sub>e</sub> ):	400 Vac (50 Hz)
Operating current (I <sub>e</sub> ):	3 A

Forms of the contact element: Zb, Y+Y, Y+Y+X, Y+Y+Y, Y+X+X  
Positive opening contacts on contact blocks 7, 9, 18, 20, 21, 22, 33, 34  
In compliance with standards: EN 60947-1, EN 60947-5-1, fundamental requirements of the Low Voltage Directive 2014/35/EU.

Please contact our technical department for the list of approved products.

## Features approved by UL

Electrical Ratings:	Q300 pilot duty (69 VA, 125-250 V dc) A600 pilot duty (720 VA, 120-600 V ac)
Environmental Ratings:	Types 1, 4X, 12, 13

Use 60 or 75 °C copper (Cu) conductor and wire size range 12, 14 AWG, stranded or solid. The terminal tightening torque of 7.1 lb in (0.8 Nm).

Please contact our technical department for the list of approved products.





**Adjustment of the switching point**

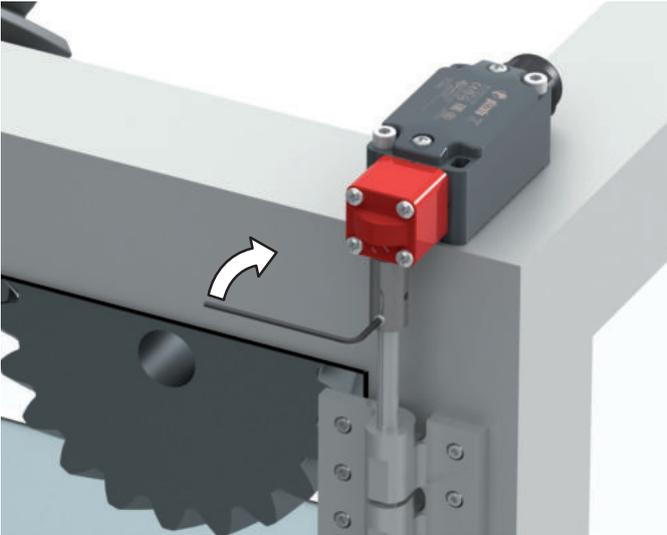

Temporary locking of the actuator (stud screw provided).

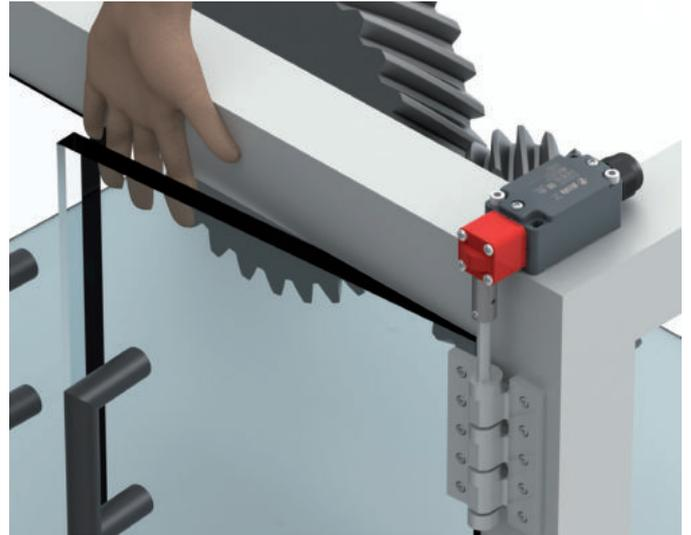

Verify the switching point according to EN ISO 13857 and recalibrate if necessary.



Pin the switch (pin is provided).

Selection diagram

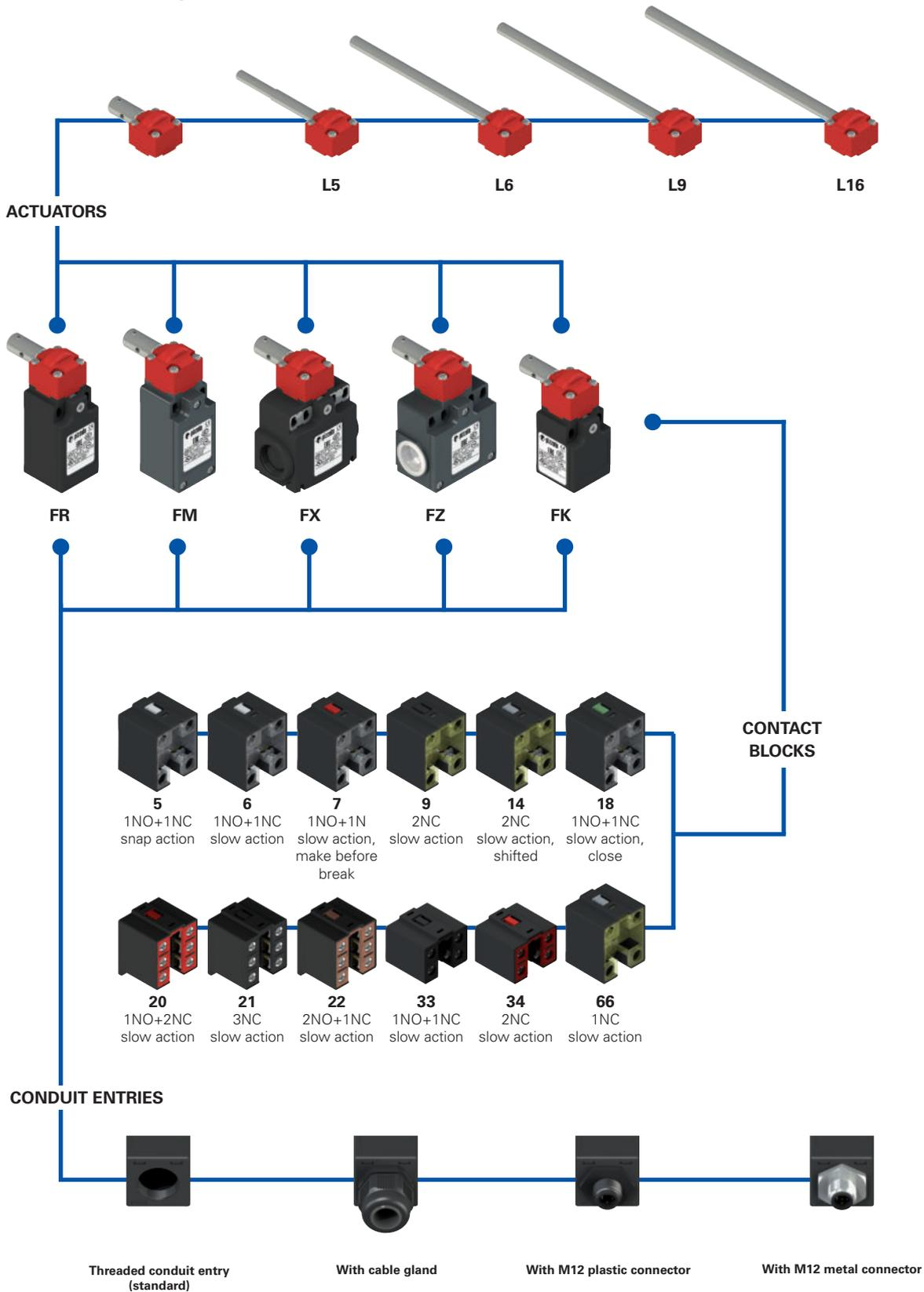

—●— product options



## Code structure

**Attention!** The feasibility of a code number does not mean the effective availability of a product. Please contact our sales office.

article
options
options  
**FR 1896-XGL16M2K70T6**

Housing	
<b>FR</b>	technopolymer, one conduit entry
<b>FM</b>	metal, one conduit entry
<b>FX</b>	technopolymer, two conduit entries
<b>FZ</b>	metal, two conduit entries

Contact blocks	
<b>5</b>	1NO+1NC, snap action
<b>6</b>	1NO+1NC, slow action
<b>7</b>	1NO+1NC, slow action, make before break
<b>9</b>	2NC, slow action
<b>14</b>	2NC, slow action, shifted
<b>18</b>	1NO+1NC, slow action, close
<b>20</b>	1NO+2NC, slow action
<b>21</b>	3NC, slow action
<b>22</b>	2NO+1NC, slow action
<b>33</b>	1NO+1NC, slow action
<b>34</b>	2NC, slow action
<b>66</b>	1NC, slow action

External metallic parts	
	zinc-plated steel (standard)
<b>X</b>	stainless steel

Contact type	
	silver contacts (standard)
<b>G</b>	silver contacts with 1 µm gold coating
<b>G1</b>	silver contacts, 2.5 µm gold coating (not for contact blocks 20, 21, 22, 33, 34)

Ambient temperature	
	-25°C ... +80°C (standard)
<b>T6</b>	-40°C ... +80°C

Pre-installed cable glands or connectors	
	no cable gland or connector (standard)
<b>K23</b>	cable gland for cables Ø 6 ... 12 mm
...	.....
<b>K70</b>	M12 plastic connector, 4-pole
...	.....

For the complete list of possible combinations please contact our technical department.

Threaded conduit entry	
<b>M2</b>	M20x1.5 (standard)
<b>M1</b>	M16x1.5 (FR-FX housing only)
	PG 13.5
<b>A</b>	PG 11 (FR-FX housing only)

Actuator design	
	actuator with hole (standard)
<b>L5</b>	Ø8x69 mm, tapered Ø6.9
<b>L6</b>	Ø8x120 mm
<b>L9</b>	Ø8x140 mm
<b>L16</b>	Ø8.7x165 mm, stainless steel

article
options
options  
**FK 3396-XGL16M1K24T6**

Housing	
<b>FK</b>	technopolymer, one conduit entry

Contact blocks	
<b>33</b>	1NO+1NC, slow action
<b>34</b>	2NC, slow action

External metallic parts	
	zinc-plated steel (standard)
<b>X</b>	stainless steel

Contact type	
	silver contacts (standard)
<b>G</b>	silver contacts with 1 µm gold coating

Ambient temperature	
	-25°C ... +80°C (standard)
<b>T6</b>	-40°C ... +80°C

Pre-installed cable glands	
	no cable gland (standard)
<b>K24</b>	cable gland for cables Ø 5 ... 10 mm
<b>K28</b>	cable gland for cables Ø 3 ... 7 mm

Threaded conduit entry	
<b>M1</b>	M16x1.5 (standard)
	PG11

Actuator design	
	actuator with hole (standard)
<b>L5</b>	Ø8x69 mm, tapered Ø6.9
<b>L6</b>	Ø8x120 mm
<b>L9</b>	Ø8x140 mm
<b>L16</b>	Ø8.7x165 mm, stainless steel



### Main features

- Metal housing or technopolymer housing, from one to two conduit entries
- Protection degree IP67
- 12 contact blocks available
- Versions with M12 connector
- Versions with gold-plated silver contacts
- Versions with stainless steel external metallic parts

### Quality marks:



IMQ approval:	EG610
UL approval:	E131787
CCC approval:	2007010305230013
EAC approval:	RU C-IT.YT03.B.00035/19

### Technical data

#### Housing

FR, FX and FK series housing made of glass fibre reinforced technopolymer, self-extinguishing, shock-proof and with double insulation: □  
 FM and FZ series: metal housing, baked powder coating.  
 FR, FM series: one threaded conduit entry: M20x1.5 (standard)  
 FK series: one threaded conduit entry: M16x1.5 (standard)  
 FX series: two knock-out threaded conduit entries: M20x1.5 (standard)  
 FZ series: two threaded conduit entries: M20x1.5 (standard)  
 Protection degree: IP67 acc. to EN 60529 with cable gland of equal or higher protection degree

#### General data

SIL (SIL CL) up to:	SIL 3 acc. to EN 62061
Performance Level (PL) up to:	PL e acc. to EN ISO 13849-1
Mechanical interlock, not coded:	type 1 acc. to EN ISO 14119
Safety parameters:	
$B_{100}$ :	5,000,00 for NC contacts
Mission time:	20 years
Ambient temperature:	-25°C ... +80°C (standard) -40°C ... +80°C (T6 option)
Max. actuation frequency:	3600 operating cycles/hour
Mechanical endurance:	1 million operating cycles
Max. actuation speed:	180°/s
Min. actuation speed:	2°/s
Tightening torques for installation:	see page 341
Wire cross-sections and wire stripping lengths:	see page 357

#### In compliance with standards:

IEC 60947-5-1, IEC 60947-1, IEC 60204-1, EN ISO 14119, EN ISO 12100, IEC 60529, EN 50581, UL 508, CSA 22.2 No.14.

#### Approvals:

EN 60947-5-1, UL 508, CSA 22.2 No.14, GB/T14048.5-2017.

#### Compliance with the requirements of:

Machinery Directive 2006/42/EC, EMC Directive 2014/30/EU, RoHS Directive 2011/65/EU.

#### Positive contact opening in conformity with standards:

IEC 60947-5-1, EN 60947-5-1.

⚠ If not expressly indicated in this chapter, for correct installation and utilization of all articles see the instructions given on pages 337 to 350.

	Electrical data	Utilization category
without connector	Thermal current ( $I_{th}$ ): 10 A Rated insulation voltage ( $U_i$ ): 500 Vac 600 Vdc 400 Vac 500 Vdc (contact blocks 20, 21, 22, 33, 34) Rated impulse withstand voltage ( $U_{imp}$ ): 6 kV 4 kV (contact blocks 20, 21, 22, 33, 34) Conditional short circuit current: 1000 A acc. to EN 60947-5-1 Protection against short circuits: type aM fuse 10 A 500 V Pollution degree: 3	Alternating current: AC15 (50±60 Hz) $U_e$ (V) 250 400 500 $I_e$ (A) 6 4 1 Direct current: DC13 $U_e$ (V) 24 125 250 $I_e$ (A) 3 0.55 0.3
with M12 connector, 4 and 5-pole	Thermal current ( $I_{th}$ ): 4 A Rated insulation voltage ( $U_i$ ): 250 Vac 300 Vdc Protection against short circuits: type gG fuse 4 A 500 V Pollution degree: 3	Alternating current: AC15 (50±60 Hz) $U_e$ (V) 24 120 250 $I_e$ (A) 4 4 4 Direct current: DC13 $U_e$ (V) 24 125 250 $I_e$ (A) 3 0.55 0.3
with M12 connector, 8-pole	Thermal current ( $I_{th}$ ): 2 A Rated insulation voltage ( $U_i$ ): 30 Vac 36 Vdc Protection against short circuits: type gG fuse 2 A 500 V Pollution degree: 3	Alternating current: AC15 (50±60 Hz) $U_e$ (V) 24 $I_e$ (A) 2 Direct current: DC13 $U_e$ (V) 24 $I_e$ (A) 2



## Description



These safety switches are designed to monitor gates or guards that safeguard dangerous parts of machines without inertia. They are very sensitive, open the contacts after few degrees of rotation and immediately send the stop signal. The head, which can be turned in 90° steps, enables installation in multiple positions. Available with technopolymer or metal housings, with protection degree IP67. The special design allows it to be used even under operating conditions in which dust and dirt could inhibit the operation of normal safety switches with separate actuator.

## Head with variable orientation

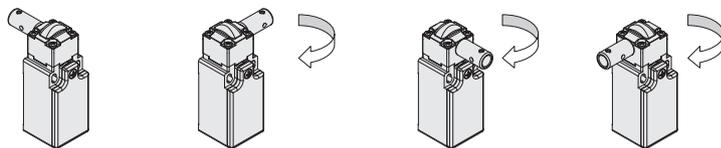

For all switches, the head can be adjusted in 90° steps after removing the four fastening screws. This allows you to use the same switch on both right- and left-facing door fronts.

## Protection degree IP67

**IP67** These devices are designed to be used in the toughest environmental conditions and they pass the IP67 immersion test acc. to EN 60529. They can therefore be used in all environments where maximum protection degree of the housing is required.

## Extended temperature range

**-40°C** These devices are also available in a special version suitable for an ambient operating temperature range from -40°C up to +80°C.

They can therefore be used for applications in cold stores, sterilisers and other equipment with low temperature environments. The special materials used to produce these versions retain their characteristics even under these conditions, thereby expanding the installation possibilities.

## Application examples

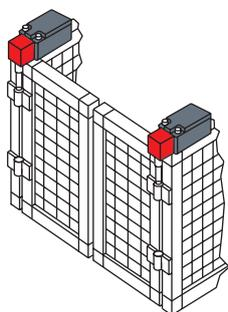

Safety switches for hinges, mounting on double door

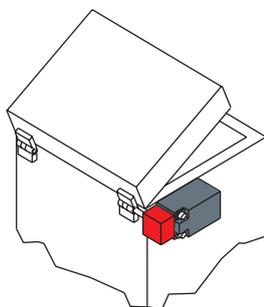

Safety switch for hinges, mounting outside the safety guard

## Adjustable switching point



When installing the device, the contact switching point can be adjusted over the entire 360° range. By fixing the stud screw, it is possible to check the correct setting of the activation angle and quickly and easily adjust it if necessary. Once adjustment is complete, you can render the device tamper-proof against commonly used tools using the supplied lock pin.

## Features approved by IMQ

Rated insulation voltage (U<sub>i</sub>): 500 Vac  
400 Vac (for contact blocks 20, 21, 22, 33, 34)  
Conventional free air thermal current (I<sub>n</sub>): 10 A  
Protection against short circuits: type aM fuse 10 A 500 V  
Rated impulse withstand voltage (U<sub>imp</sub>): 6 kV  
4 kV (for contact blocks 20, 21, 22, 33, 34)  
Protection degree of the housing: IP67  
MV terminals (screw terminals)  
Pollution degree: 3  
Utilization category: AC15  
Operating voltage (U<sub>e</sub>): 400 Vac (50 Hz)  
Operating current (I<sub>e</sub>): 3 A  
Forms of the contact element: Zb, Y+Y, Y+Y+X, Y+Y+Y, Y+X+X  
Positive opening contacts on contact blocks 5, 6, 7, 9, 14, 18, 20, 21, 22, 33, 34, 66.  
In compliance with standards: EN 60947-1, EN 60947-5-1, fundamental requirements of the Low Voltage Directive 2014/35/EU.

Please contact our technical department for the list of approved products.

## Features approved by UL

Electrical Ratings: Q300 pilot duty (69 VA, 125-250 V dc)  
A600 pilot duty (720 VA, 120-600 V ac)  
Environmental Ratings: Types 1, 4X, 12, 13  
Use 60 or 75 °C copper (Cu) conductor and wire size range 12, 14 AWG, stranded or solid. The terminal tightening torque of 7.1 lb in (0.8 Nm).  
For FR, FX, FK series: the hub is to be connected to the conduit before the hub is connected to the enclosure.

Please contact our technical department for the list of approved products.

Contact type:  
**R** = snap action  
**L** = slow action  
**LO** = slow action make before break  
**LS** = slow action shifted

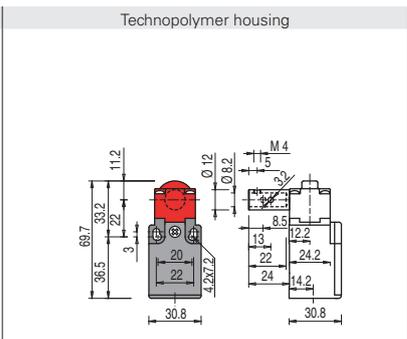
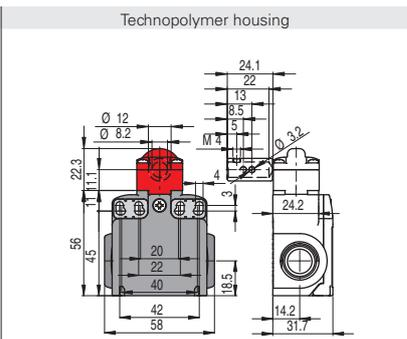
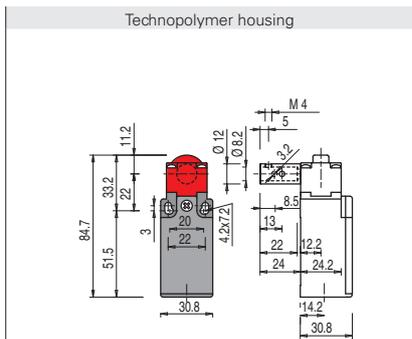

Contact blocks

5	<b>R</b>	FR 596-M2	↻	1NO+1NC	FX 596-M2	↻	1NO+1NC	/
6	<b>L</b>	FR 696-M2	↻	1NO+1NC	FX 696-M2	↻	1NO+1NC	/
7	<b>LO</b>	FR 796-M2	↻	1NO+1NC	FX 796-M2	↻	1NO+1NC	/
9	<b>L</b>	FR 996-M2	↻	2NC	FX 996-M2	↻	2NC	/
14	<b>LS</b>	FR 1496-M2	↻	2NC	FX 1496-M2	↻	2NC	/
18	<b>L</b>	FR 1896-M2	↻	1NO+1NC	FX 1896-M2	↻	1NO+1NC	/
20	<b>L</b>	FR 2096-M2	↻	1NO+2NC	FX 2096-M2	↻	1NO+2NC	/
21	<b>L</b>	FR 2196-M2	↻	3NC	FX 2196-M2	↻	3NC	/
22	<b>L</b>	FR 2296-M2	↻	2NO+1NC	FX 2296-M2	↻	2NO+1NC	/
33	<b>L</b>	FR 3396-M2	↻	1NO+1NC	FX 3396-M2	↻	1NO+1NC	FK 3396-M1 ↻ 1NO+1NC
34	<b>L</b>	FR 3496-M2	↻	2NC	FX 3496-M2	↻	2NC	FK 3496-M1 ↻ 2NC
66	<b>L</b>	FR 6696-M2	↻	1NC	FX 6696-M2	↻	1NC	/
Actuating force		0.15 Nm (0.4 Nm ↻)		0.15 Nm (0.4 Nm ↻)		0.15 Nm (0.4 Nm ↻)		
Travel diagrams		page 344 - group 9		page 344 - group 9		page 344 - group 9		

Contact type:  
**R** = snap action  
**L** = slow action  
**LO** = slow action make before break  
**LS** = slow action shifted

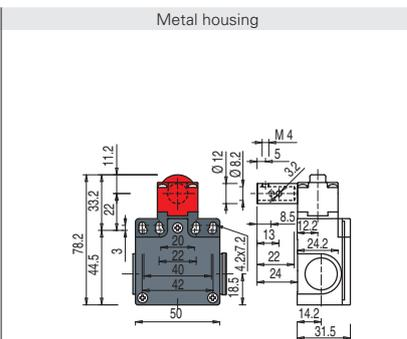
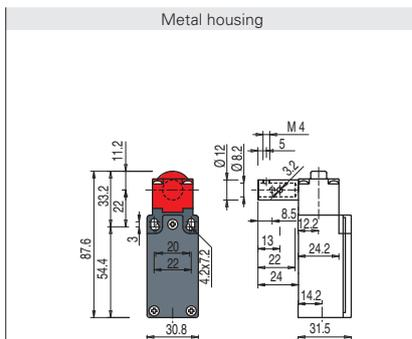

Contact blocks

5	<b>R</b>	FM 596-M2	↻	1NO+1NC	FZ 596-M2	↻	1NO+1NC
6	<b>L</b>	FM 696-M2	↻	1NO+1NC	FZ 696-M2	↻	1NO+1NC
7	<b>LO</b>	FM 796-M2	↻	1NO+1NC	FZ 796-M2	↻	1NO+1NC
9	<b>L</b>	FM 996-M2	↻	2NC	FZ 996-M2	↻	2NC
14	<b>LS</b>	FM 1496-M2	↻	2NC	FZ 1496-M2	↻	2NC
18	<b>L</b>	FM 1896-M2	↻	1NO+1NC	FZ 1896-M2	↻	1NO+1NC
20	<b>L</b>	FM 2096-M2	↻	1NO+2NC	FZ 2096-M2	↻	1NO+2NC
21	<b>L</b>	FM 2196-M2	↻	3NC	FZ 2196-M2	↻	3NC
22	<b>L</b>	FM 2296-M2	↻	2NO+1NC	FZ 2296-M2	↻	2NO+1NC
33	<b>L</b>	FM 3396-M2	↻	1NO+1NC	FZ 3396-M2	↻	1NO+1NC
34	<b>L</b>	FM 3496-M2	↻	2NC	FZ 3496-M2	↻	2NC
66	<b>L</b>	FM 6696-M2	↻	1NC	FZ 6696-M2	↻	1NC
Actuating force		0.15 Nm (0.4 Nm ↻)		0.15 Nm (0.4 Nm ↻)			
Travel diagrams		page 344 - group 9		page 344 - group 9			



## Dimensional drawings for actuators

Option	Drawing
L5	
L6	
L9	
L16	

## Adjustment of the switching point

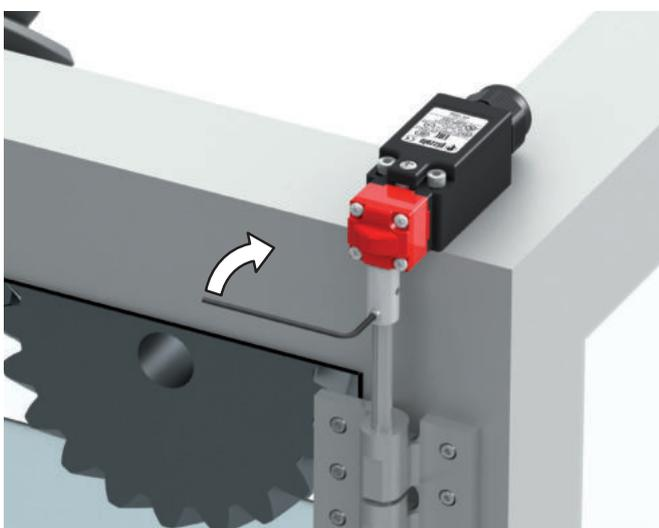

Temporary locking of the actuator (stud screw provided).

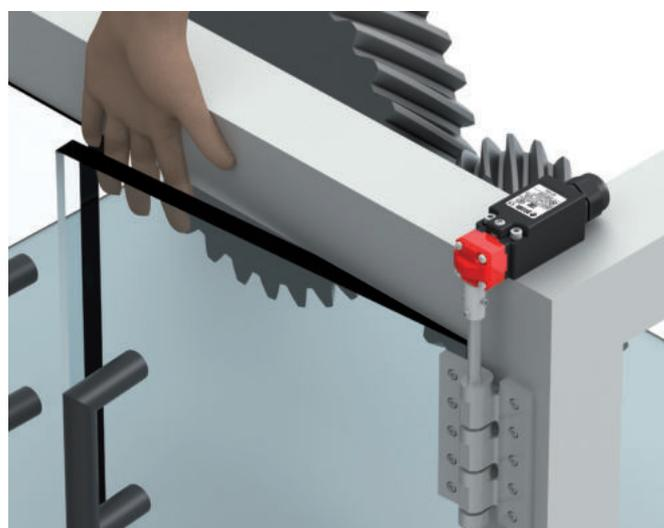

Verify the switching point according to EN ISO 13857 and recalibrate if necessary.

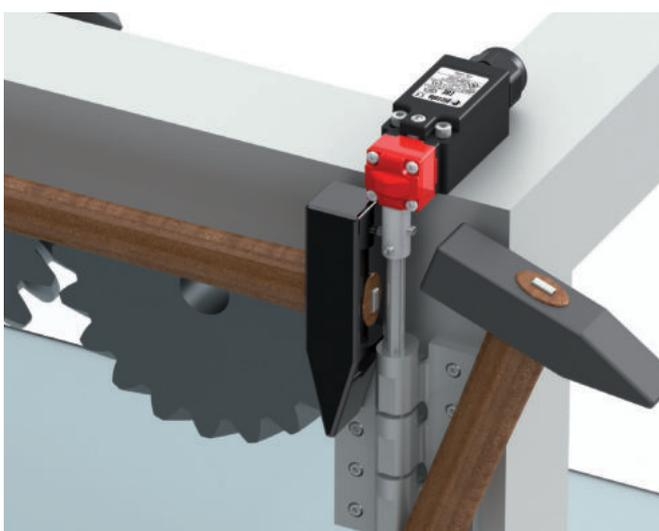

Pin the switch (pin is provided).

Selection diagram

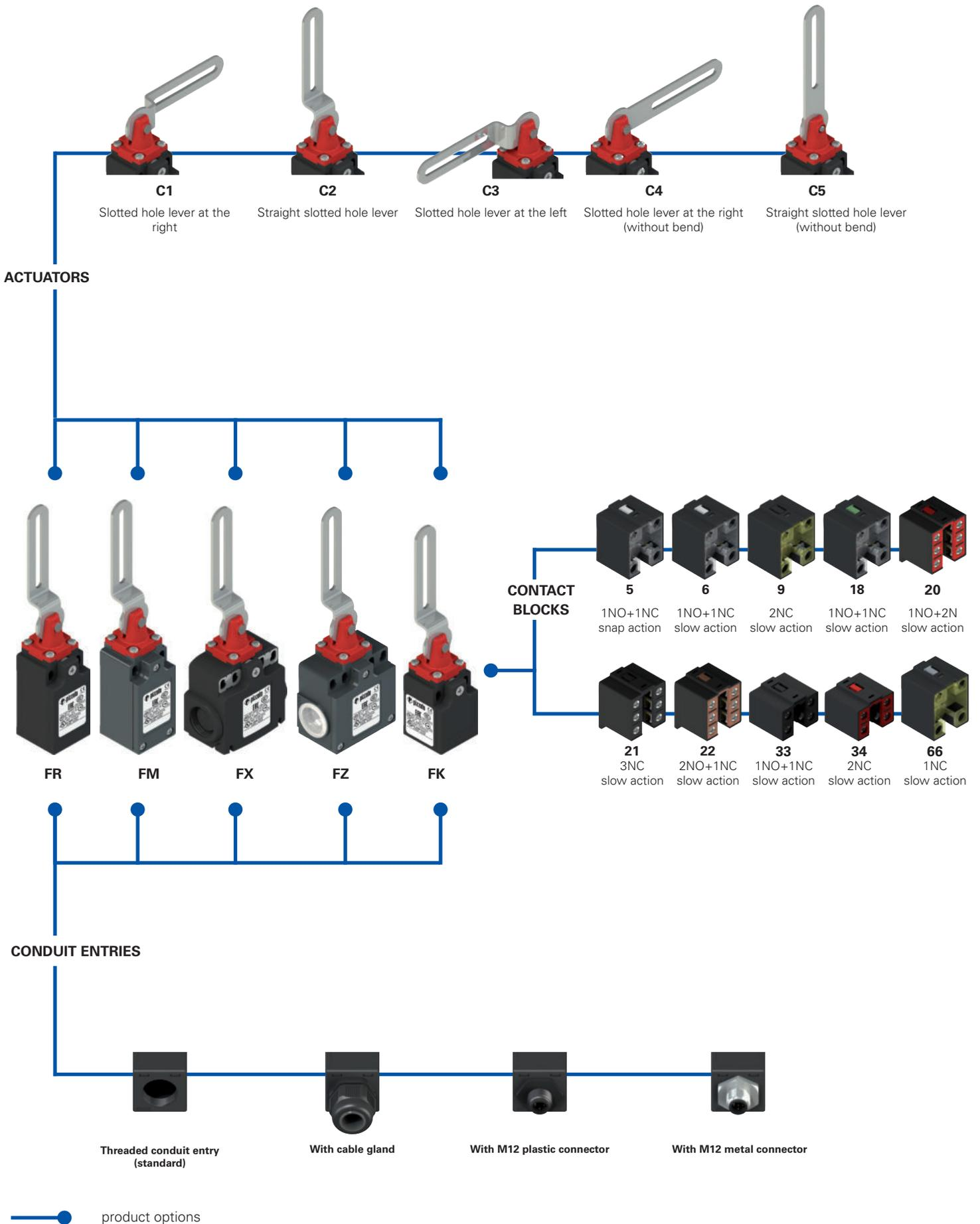



## Code structure

**Attention!** The feasibility of a code number does not mean the effective availability of a product. Please contact our sales office.

article
options
options  
**FR 18C1-GM2K70T6**

Housing	
<b>FR</b>	technopolymer, one conduit entry
<b>FM</b>	metal, one conduit entry
<b>FX</b>	technopolymer, two conduit entries
<b>FZ</b>	metal, two conduit entries

Contact blocks	
<b>5</b>	1NO+1NC, snap action
<b>6</b>	1NO+1NC, slow action
<b>9</b>	2NC, slow action
<b>18</b>	1NO+1NC, slow action
<b>20</b>	1NO+2NC, slow action
<b>21</b>	3NC, slow action
<b>22</b>	2NO+1NC, slow action
<b>33</b>	1NO+1NC, slow action
<b>34</b>	2NC, slow action
<b>66</b>	1NC, slow action

Actuators	
<b>C1</b>	slotted hole lever at the right
<b>C2</b>	straight slotted hole lever
<b>C3</b>	slotted hole lever at the left
<b>C4</b>	slotted hole lever at the right (without bend)
<b>C5</b>	straight slotted hole lever (without bend)

Ambient temperature	
	-25°C ... +80°C (standard)
<b>T6</b>	-40°C ... +80°C

Pre-installed cable glands or connectors	
	no cable gland or connector (standard)
<b>K23</b>	cable gland for cables Ø 6 ... 12 mm
...	.....
<b>K70</b>	M12 plastic connector, 4-pole
...	.....

For the complete list of possible combinations please contact our technical department.

Threaded conduit entry	
<b>M2</b>	M20x1.5 (standard)
<b>M1</b>	M16x1.5 (FR-FX housing only)
	PG 13.5
<b>A</b>	PG 11 (FR-FX housing only)

Contact type	
	silver contacts (standard)
<b>G</b>	silver contacts with 1 µm gold coating
<b>G1</b>	silver contacts, 2.5 µm gold coating (not for contact blocks 20, 21, 22, 33, 34)

article
options
options  
**FK 33C1-GM1K24T6**

Housing	
<b>FK</b>	technopolymer, one conduit entry

Contact blocks	
<b>33</b>	1NO+1NC, slow action
<b>34</b>	2NC, slow action

Actuators	
<b>C1</b>	slotted hole lever at the right
<b>C2</b>	straight slotted hole lever
<b>C3</b>	slotted hole lever at the left
<b>C4</b>	slotted hole lever at the right (without bend)
<b>C5</b>	straight slotted hole lever (without bend)

Ambient temperature	
	-25°C ... +80°C (standard)
<b>T6</b>	-40°C ... +80°C

Pre-installed cable glands	
	no cable gland (standard)
<b>K24</b>	cable gland for cables Ø 5 ... 10°mm
<b>K28</b>	cable gland for cables Ø 3 ... 7°mm

Threaded conduit entry	
<b>M1</b>	M16x1.5 (standard)
	PG 11

Contact type	
	silver contacts (standard)
<b>G</b>	silver contacts with 1 µm gold coating



### Main features

- Metal housing or technopolymer housing, from one to two conduit entries
- Protection degree IP67
- 10 contact blocks available
- Versions with M12 connector
- Versions with gold-plated silver contacts

### Quality marks:



IMQ approval:	EG610
UL approval:	E131787
CCC approval:	2007010305230013
EAC approval:	RU C-IT.YT03.B.00035/19

### Technical data

#### Housing

FR, FX and FK series housing made of glass fibre reinforced technopolymer, self-extinguishing, shock-proof and with double insulation:

FM and FZ series: metal housing, baked powder coating.

FR, FM series: one threaded conduit entry: M20x1.5 (standard)

FK series: one threaded conduit entry: M16x1.5 (standard)

FX series: two knock-out threaded conduit entries: M20x1.5 (standard)

FZ series: two threaded conduit entries: M20x1.5 (standard)

Protection degree: IP67 acc. to EN 60529 with cable gland of equal or higher protection degree

#### General data

SIL (SIL CL) up to: SIL 3 acc. to EN 62061

Performance Level (PL) up to: PL e acc. to EN ISO 13849-1

Mechanical interlock, not coded: type 1 acc. to EN ISO 14119

Safety parameters:

$B_{10D}$ : 2,000,000 for NC contacts

Mission time: 20 years

Ambient temperature: -25°C ... +80°C (standard)

-40°C ... +80°C (T6 option)

Max. actuation frequency: 3600 operating cycles/hour

Mechanical endurance: 1 million operating cycles

Max. actuation speed: 180°/s

Min. actuation speed: 2°/s

Tightening torques for installation: see page 341

Wire cross-sections and

wire stripping lengths: see page 357

#### In compliance with standards:

IEC 60947-5-1, IEC 60947-1, IEC 60204-1, EN ISO 14119, EN ISO 12100, IEC 60529, EN 50581, UL 508, CSA 22.2 No.14

#### Approvals:

EN 60947-5-1, UL 508, CSA 22.2 No.14, GB/T14048.5-2017.

#### Compliance with the requirements of:

Machinery Directive 2006/42/EC, EMC Directive 2014/30/EU, RoHS Directive 2011/65/EU.

#### Positive contact opening in conformity with standards:

IEC 60947-5-1, EN 60947-5-1.

If not expressly indicated in this chapter, for correct installation and utilization of all articles see the instructions given on pages 337 to 350.

	Electrical data	Utilization category
without connector	Thermal current ( $I_{th}$ ): 10 A Rated insulation voltage ( $U_r$ ): 500 Vac 600 Vdc 400 Vac 500 Vdc (contact blocks 20, 21, 22, 33, 34) Rated impulse withstand voltage ( $U_{imp}$ ): 6 kV 4 kV (contact blocks 20, 21, 22, 33, 34) Conditional short circuit current: 1000 A acc. to EN 60947-5-1 Protection against short circuits: type aM fuse 10 A 500 V Pollution degree: 3	Alternating current: AC15 (50÷60 Hz) $U_e$ (V) 250 400 500 $I_e$ (A) 6 4 1 Direct current: DC13 $U_e$ (V) 24 125 250 $I_e$ (A) 3 0.55 0.3
with M12 connector, 4 and 5-pole	Thermal current ( $I_{th}$ ): 4 A Rated insulation voltage ( $U_r$ ): 250 Vac 300 Vdc Protection against short circuits: type gG fuse 4 A 500 V Pollution degree: 3	Alternating current: AC15 (50÷60 Hz) $U_e$ (V) 24 120 250 $I_e$ (A) 4 4 4 Direct current: DC13 $U_e$ (V) 24 125 250 $I_e$ (A) 3 0.55 0.3
with M12 connector, 8-pole	Thermal current ( $I_{th}$ ): 2 A Rated insulation voltage ( $U_r$ ): 30 Vac 36 Vdc Protection against short circuits: type gG fuse 2 A 500 V Pollution degree: 3	Alternating current: AC15 (50÷60 Hz) $U_e$ (V) 24 $I_e$ (A) 2 Direct current: DC13 $U_e$ (V) 24 $I_e$ (A) 2



## Description



These safety switches are used to control gates or guards with hinges protecting dangerous parts of machines without inertia. Easy to install, they do not need the interaction with the hinge of the guard. They are very sensitive, open the contacts after few degrees of rotation and immediately send the stop signal.

## Head with variable orientation

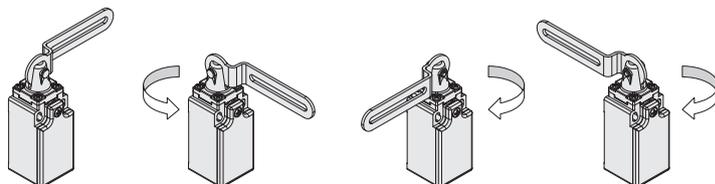

For all switches, the head can be adjusted in 90° steps after removing the four fastening screws. This allows you to use the same switch on both right- and left-facing door fronts.

## Application examples

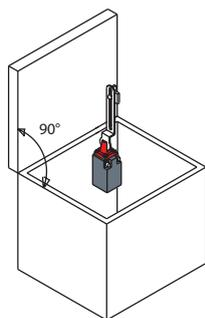

Safety switch with slotted hole lever, mounting inside the safety guard

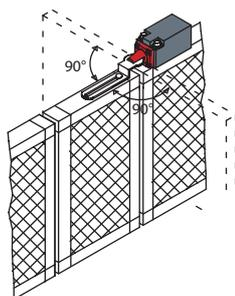

Safety switch with slotted hole lever, mounting on guards which open up to 180°

## Protection degree IP67

**IP67** These devices are designed to be used in the toughest environmental conditions and they pass the IP67 immersion test acc. to EN 60529. They can therefore be used in all environments where maximum protection degree of the housing is required.

## Extended temperature range

**-40°C** These devices are also available in a special version suitable for an ambient operating temperature range from -40°C up to +80°C.

They can therefore be used for applications in cold stores, sterilisers and other equipment with low temperature environments. The special materials used to produce these versions retain their characteristics even under these conditions, thereby expanding the installation possibilities.

## Features approved by IMQ

Rated insulation voltage ( $U_i$ ):	500 Vac 400 Vac (for contact blocks 20, 21, 22, 33, 34)
Conventional free air thermal current ( $I_{th}$ ):	10 A
Protection against short circuits:	type aM fuse 10 A 500 V
Rated impulse withstand voltage ( $U_{imp}$ ):	6 kV 4 kV (for contact blocks 20, 21, 22, 33, 34)
Protection degree of the housing:	IP67
MV terminals (screw terminals)	
Pollution degree:	3
Utilization category:	AC15
Operating voltage ( $U_e$ ):	400 Vac (50 Hz)
Operating current ( $I_e$ ):	3 A
Forms of the contact element:	Zb, Y+Y, Y+Y+X, Y+Y+Y, Y+X+X
Positive opening contacts on contact blocks:	5, 7, 9, 18, 20, 21, 22, 33, 34, 66
In compliance with standards:	EN 60947-1, EN 60947-5-1, fundamental requirements of the Low Voltage Directive 2014/35/EU.

Please contact our technical department for the list of approved products.

## Features approved by UL

Electrical Ratings:	Q300 pilot duty (69 VA, 125-250 V dc) A600 pilot duty (720 VA, 120-600 V ac)
Environmental Ratings:	Types 1, 4X, 12, 13
	Use 60 or 75 °C copper (Cu) conductor and wire size range 12, 14 AWG, stranded or solid. The terminal tightening torque of 7.1 lb in (0.8 Nm).
	For FR, FX, FK series: the hub is to be connected to the conduit before the hub is connected to the enclosure.

Please contact our technical department for the list of approved products.

# Safety switches with slotted hole lever

	Technopolymer housing		Technopolymer housing		Technopolymer housing					
<p>Contact type:</p> <p><b>R</b> = snap action  <b>L</b> = slow action  <b>LA</b> = slow action close</p>										
Contact blocks										
5	<b>R</b>	FR 5C1-M2	↻	1NO+1NC	FR 5C2-M2	↻	1NO+1NC	FR 5C3-M2	↻	1NO+1NC
6	<b>L</b>	FR 6C1-M2	↻	1NO+1NC	FR 6C2-M2	↻	1NO+1NC	FR 6C3-M2	↻	1NO+1NC
9	<b>L</b>	FR 9C1-M2	↻	2NC	FR 9C2-M2	↻	2NC	FR 9C3-M2	↻	2NC
18	<b>LA</b>	FR 18C1-M2	↻	1NO+1NC	FR 18C2-M2	↻	1NO+1NC	FR 18C3-M2	↻	1NO+1NC
20	<b>L</b>	FR 20C1-M2	↻	1NO+2NC	FR 20C2-M2	↻	1NO+2NC	FR 20C3-M2	↻	1NO+2NC
21	<b>L</b>	FR 21C1-M2	↻	3NC	FR 21C2-M2	↻	3NC	FR 21C3-M2	↻	3NC
22	<b>L</b>	FR 22C1-M2	↻	2NO+1NC	FR 22C2-M2	↻	2NO+1NC	FR 22C3-M2	↻	2NO+1NC
33	<b>L</b>	FR 33C1-M2	↻	1NO+1NC	FR 33C2-M2	↻	1NO+1NC	FR 33C3-M2	↻	1NO+1NC
34	<b>L</b>	FR 34C1-M2	↻	2NC	FR 34C2-M2	↻	2NC	FR 34C3-M2	↻	2NC
66	<b>L</b>	FR 66C1-M2	↻	1NC	FR 66C2-M2	↻	1NC	FR 66C3-M2	↻	1NC
Actuating force	0.11 Nm (0.15 Nm ↻)		0.11 Nm (0.15 Nm ↻)		0.11 Nm (0.15 Nm ↻)					
Travel diagrams	page 344 - group 10		page 344 - group 11		page 344 - group 10					

	Technopolymer housing		Technopolymer housing				
<p>Contact type:</p> <p><b>R</b> = snap action  <b>L</b> = slow action  <b>LA</b> = slow action close</p>							
Contact blocks							
5	<b>R</b>	FR 5C4-M2	↻	1NO+1NC	FR 5C5-M2	↻	1NO+1NC
6	<b>L</b>	FR 6C4-M2	↻	1NO+1NC	FR 6C5-M2	↻	1NO+1NC
9	<b>L</b>	FR 9C4-M2	↻	2NC	FR 9C5-M2	↻	2NC
18	<b>LA</b>	FR 18C4-M2	↻	1NO+1NC	FR 18C5-M2	↻	1NO+1NC
20	<b>L</b>	FR 20C4-M2	↻	1NO+2NC	FR 20C5-M2	↻	1NO+2NC
21	<b>L</b>	FR 21C4-M2	↻	3NC	FR 21C5-M2	↻	3NC
22	<b>L</b>	FR 22C4-M2	↻	2NO+1NC	FR 22C5-M2	↻	2NO+1NC
33	<b>L</b>	FR 33C4-M2	↻	1NO+1NC	FR 33C5-M2	↻	1NO+1NC
34	<b>L</b>	FR 34C4-M2	↻	2NC	FR 34C5-M2	↻	2NC
66	<b>L</b>	FR 66C4-M2	↻	1NC	FR 66C5-M2	↻	1NC
Actuating force	0.11 Nm (0.15 Nm ↻)		0.11 Nm (0.15 Nm ↻)				
Travel diagrams	page 344 - group 10		page 344 - group 11				

All values in the drawings are in mm



		Metal housing	Metal housing	Metal housing	
Contact type:		<p><b>R</b> = snap action  <b>L</b> = slow action  <b>LA</b> = slow action close</p>			
Contact blocks					
5	<b>R</b>	FM 5C1-M2	➔ 1NO+1NC	FM 5C3-M2	➔ 1NO+1NC
6	<b>L</b>	FM 6C1-M2	➔ 1NO+1NC	FM 6C3-M2	➔ 1NO+1NC
9	<b>L</b>	FM 9C1-M2	➔ 2NC	FM 9C3-M2	➔ 2NC
18	<b>LA</b>	FM 18C1-M2	➔ 1NO+1NC	FM 18C3-M2	➔ 1NO+1NC
20	<b>L</b>	FM 20C1-M2	➔ 1NO+2NC	FM 20C3-M2	➔ 1NO+2NC
21	<b>L</b>	FM 21C1-M2	➔ 3NC	FM 21C3-M2	➔ 3NC
22	<b>L</b>	FM 22C1-M2	➔ 2NO+1NC	FM 22C3-M2	➔ 2NO+1NC
33	<b>L</b>	FM 33C1-M2	➔ 1NO+1NC	FM 33C3-M2	➔ 1NO+1NC
34	<b>L</b>	FM 34C1-M2	➔ 2NC	FM 34C3-M2	➔ 2NC
66	<b>L</b>	FM 66C1-M2	➔ 1NC	FM 66C3-M2	➔ 1NC
Actuating force		0.11 Nm (0.15 Nm ➔)		0.11 Nm (0.15 Nm ➔)	
Travel diagrams		page 344 - group 10		page 344 - group 10	

		Metal housing	Metal housing		
Contact type:		<p><b>R</b> = snap action  <b>L</b> = slow action  <b>LA</b> = slow action close</p>			
Contact blocks					
5	<b>R</b>	FM 5C4-M2	➔ 1NO+1NC	FM 5C5-M2	➔ 1NO+1NC
6	<b>L</b>	FM 6C4-M2	➔ 1NO+1NC	FM 6C5-M2	➔ 1NO+1NC
9	<b>L</b>	FM 9C4-M2	➔ 2NC	FM 9C5-M2	➔ 2NC
18	<b>LA</b>	FM 18C4-M2	➔ 1NO+1NC	FM 18C5-M2	➔ 1NO+1NC
20	<b>L</b>	FM 20C4-M2	➔ 1NO+2NC	FM 20C5-M2	➔ 1NO+2NC
21	<b>L</b>	FM 21C4-M2	➔ 3NC	FM 21C5-M2	➔ 3NC
22	<b>L</b>	FM 22C4-M2	➔ 2NO+1NC	FM 22C5-M2	➔ 2NO+1NC
33	<b>L</b>	FM 33C4-M2	➔ 1NO+1NC	FM 33C5-M2	➔ 1NO+1NC
34	<b>L</b>	FM 34C4-M2	➔ 2NC	FM 34C5-M2	➔ 2NC
66	<b>L</b>	FM 66C4-M2	➔ 1NC	FM 66C5-M2	➔ 1NC
Actuating force		0.11 Nm (0.15 Nm ➔)		0.11 Nm (0.15 Nm ➔)	
Travel diagrams		page 344 - group 10		page 344 - group 11	

# Safety switches with slotted hole lever

Contact type:

- R** = snap action
- L** = slow action
- LA** = slow action close

	Technopolymer housing		Technopolymer housing		Technopolymer housing		
Contact blocks							
5	<b>R</b>	FX 5C1-M2	↻	1NO+1NC	FX 5C2-M2	↻	1NO+1NC
6	<b>L</b>	FX 6C1-M2	↻	1NO+1NC	FX 6C2-M2	↻	1NO+1NC
9	<b>L</b>	FX 9C1-M2	↻	2NC	FX 9C2-M2	↻	2NC
18	<b>LA</b>	FX 18C1-M2	↻	1NO+1NC	FX 18C2-M2	↻	1NO+1NC
20	<b>L</b>	FX 20C1-M2	↻	1NO+2NC	FX 20C2-M2	↻	1NO+2NC
21	<b>L</b>	FX 21C1-M2	↻	3NC	FX 21C2-M2	↻	3NC
22	<b>L</b>	FX 22C1-M2	↻	2NO+1NC	FX 22C2-M2	↻	2NO+1NC
33	<b>L</b>	FX 33C1-M2	↻	1NO+1NC	FX 33C2-M2	↻	1NO+1NC
34	<b>L</b>	FX 34C1-M2	↻	2NC	FX 34C2-M2	↻	2NC
66	<b>L</b>	FX 66C1-M2	↻	1NC	FX 66C2-M2	↻	1NC
Actuating force	0.11 Nm (0.15 Nm ↻)		0.11 Nm (0.15 Nm ↻)		0.11 Nm (0.15 Nm ↻)		
Travel diagrams	page 344 - group 10		page 344 - group 11		page 344 - group 10		

Contact type:

- R** = snap action
- L** = slow action
- LA** = slow action close

	Technopolymer housing		Technopolymer housing	
Contact blocks				
5	<b>R</b>	FX 5C4-M2	↻	1NO+1NC
6	<b>L</b>	FX 6C4-M2	↻	1NO+1NC
9	<b>L</b>	FX 9C4-M2	↻	2NC
18	<b>LA</b>	FX 18C4-M2	↻	1NO+1NC
20	<b>L</b>	FX 20C4-M2	↻	1NO+2NC
21	<b>L</b>	FX 21C4-M2	↻	3NC
22	<b>L</b>	FX 22C4-M2	↻	2NO+1NC
33	<b>L</b>	FX 33C4-M2	↻	1NO+1NC
34	<b>L</b>	FX 34C4-M2	↻	2NC
66	<b>L</b>	FX 66C4-M2	↻	1NC
Actuating force	0.11 Nm (0.15 Nm ↻)		0.11 Nm (0.15 Nm ↻)	
Travel diagrams	page 344 - group 10		page 344 - group 11	





		Metal housing	Metal housing	Metal housing						
Contact type: <b>R</b> = snap action <b>L</b> = slow action <b>LA</b> = slow action close										
Contact blocks										
5	<b>R</b>	FZ 5C1-M2	➔	1NO+1NC	FZ 5C2-M2	➔	1NO+1NC	FZ 5C3-M2	➔	1NO+1NC
6	<b>L</b>	FZ 6C1-M2	➔	1NO+1NC	FZ 6C2-M2	➔	1NO+1NC	FZ 6C3-M2	➔	1NO+1NC
9	<b>L</b>	FZ 9C1-M2	➔	2NC	FZ 9C2-M2	➔	2NC	FZ 9C3-M2	➔	2NC
18	<b>LA</b>	FZ 18C1-M2	➔	1NO+1NC	FZ 18C2-M2	➔	1NO+1NC	FZ 18C3-M2	➔	1NO+1NC
20	<b>L</b>	FZ 20C1-M2	➔	1NO+2NC	FZ 20C2-M2	➔	1NO+2NC	FZ 20C3-M2	➔	1NO+2NC
21	<b>L</b>	FZ 21C1-M2	➔	3NC	FZ 21C2-M2	➔	3NC	FZ 21C3-M2	➔	3NC
22	<b>L</b>	FZ 22C1-M2	➔	2NO+1NC	FZ 22C2-M2	➔	2NO+1NC	FZ 22C3-M2	➔	2NO+1NC
33	<b>L</b>	FZ 33C1-M2	➔	1NO+1NC	FZ 33C2-M2	➔	1NO+1NC	FZ 33C3-M2	➔	1NO+1NC
34	<b>L</b>	FZ 34C1-M2	➔	2NC	FZ 34C2-M2	➔	2NC	FZ 34C3-M2	➔	2NC
66	<b>L</b>	FZ 66C1-M2	➔	1NC	FZ 66C2-M2	➔	1NC	FZ 66C3-M2	➔	1NC
Actuating force		0.11 Nm (0.15 Nm ➔)			0.11 Nm (0.15 Nm ➔)			0.11 Nm (0.15 Nm ➔)		
Travel diagrams		page 344 - group 10			page 344 - group 11			page 344 - group 10		

		Metal housing	Metal housing				
Contact type: <b>R</b> = snap action <b>L</b> = slow action <b>LA</b> = slow action close							
Contact blocks							
5	<b>R</b>	FZ 5C4-M2	➔	1NO+1NC	FZ 5C5-M2	➔	1NO+1NC
6	<b>L</b>	FZ 6C4-M2	➔	1NO+1NC	FZ 6C5-M2	➔	1NO+1NC
9	<b>L</b>	FZ 9C4-M2	➔	2NC	FZ 9C5-M2	➔	2NC
18	<b>LA</b>	FZ 18C4-M2	➔	1NO+1NC	FZ 18C5-M2	➔	1NO+1NC
20	<b>L</b>	FZ 20C4-M2	➔	1NO+2NC	FZ 20C5-M2	➔	1NO+2NC
21	<b>L</b>	FZ 21C4-M2	➔	3NC	FZ 21C5-M2	➔	3NC
22	<b>L</b>	FZ 22C4-M2	➔	2NO+1NC	FZ 22C5-M2	➔	2NO+1NC
33	<b>L</b>	FZ 33C4-M2	➔	1NO+1NC	FZ 33C5-M2	➔	1NO+1NC
34	<b>L</b>	FZ 34C4-M2	➔	2NC	FZ 34C5-M2	➔	2NC
66	<b>L</b>	FZ 66C4-M2	➔	1NC	FZ 66C5-M2	➔	1NC
Actuating force		0.11 Nm (0.15 Nm ➔)			0.11 Nm (0.15 Nm ➔)		
Travel diagrams		page 344 - group 10			page 344 - group 11		

All values in the drawings are in mm

	Technopolymer housing		Technopolymer housing		Technopolymer housing	
Contact type:						
<input type="checkbox"/> L = slow action						
Contact blocks						
33 <input type="checkbox"/> L	FK 33C1-M1		1NO+1NC	FK 33C2-M1		1NO+1NC
34 <input type="checkbox"/> L	FK 34C1-M1		2NC	FK 34C2-M1		2NC
Actuating force	0.11 Nm (0.15 Nm			0.11 Nm (0.15 Nm		
Travel diagrams	page 344 - group 10			page 344 - group 11		
				FK 33C3-M1		
				FK 34C3-M1		
				1NO+1NC		
				2NC		
				0.11 Nm (0.15 Nm		
				page 344 - group 10		

	Technopolymer housing		Technopolymer housing		
Contact type:					
<input type="checkbox"/> L = slow action					
Contact blocks					
33 <input type="checkbox"/> L	FK 33C4-M1		1NO+1NC	FK 33C5-M1	
34 <input type="checkbox"/> L	FK 34C4-M1		2NC	FK 34C5-M1	
Actuating force	0.11 Nm (0.15 Nm			0.11 Nm (0.15 Nm	
Travel diagrams	page 344 - group 10			page 344 - group 11	



Selection diagram

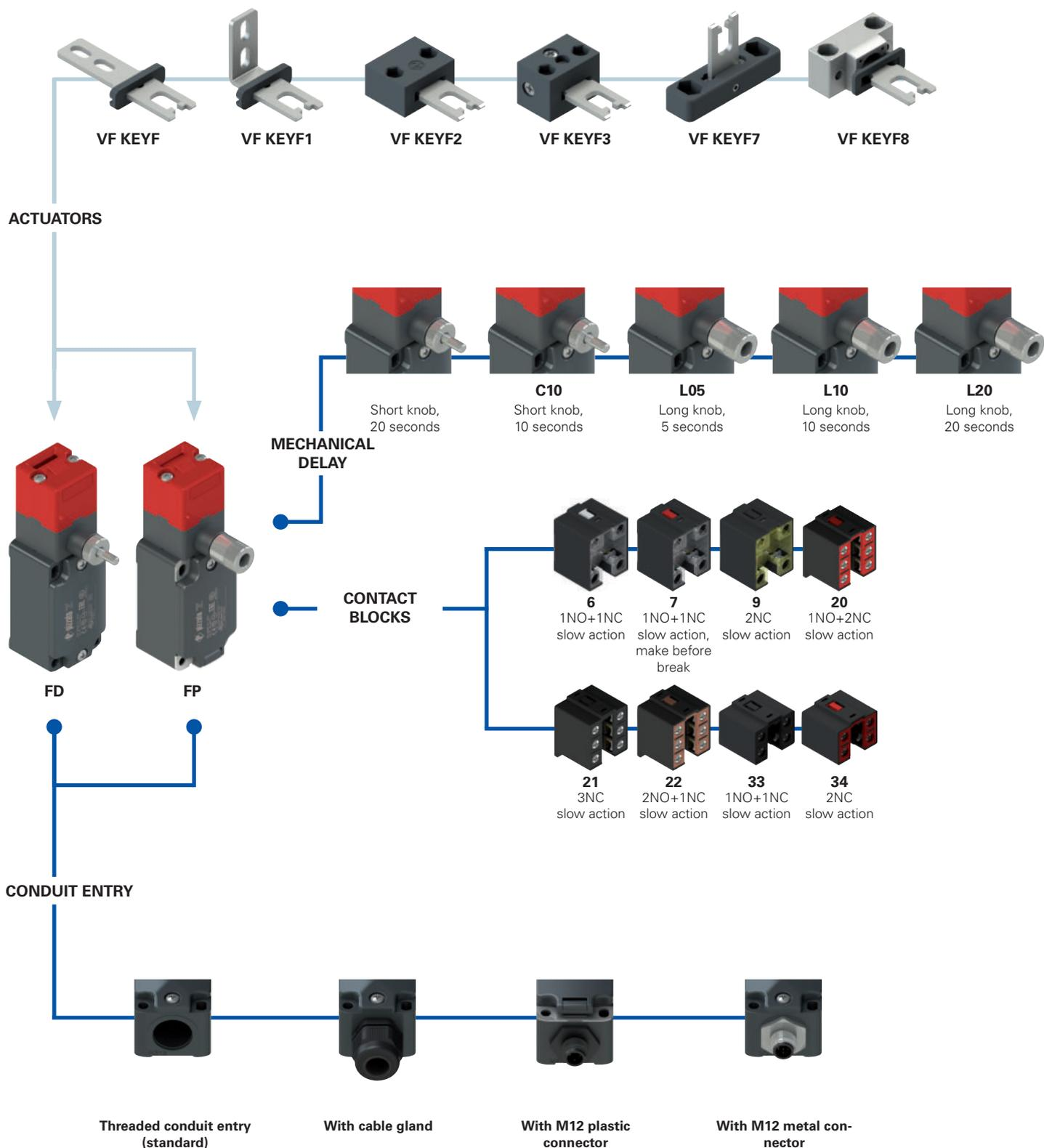



**Code structure** **Attention!** The feasibility of a code number does not mean the effective availability of a product. Please contact our sales office.

article options options  
**FD 6R2-L10F1GM2K50T6**

Housing	
<b>FD</b>	metal, one conduit entry
<b>FP</b>	technopolymer, one conduit entry

Ambient temperature	
	-25°C ... +80°C (standard)
<b>T6</b>	-40°C ... +80°C

Contact blocks	
<b>6</b>	1NO+1NC, slow action
<b>7</b>	1NO+1NC, slow action, make before break
<b>9</b>	2NC, slow action
<b>20</b>	1NO+2NC, slow action
<b>21</b>	3NC, slow action
<b>22</b>	2NO+1NC, slow action
<b>33</b>	1NO+1NC, slow action
<b>34</b>	2NC, slow action

Pre-installed cable glands or connectors	
	no cable gland or connector (standard)
<b>K23</b>	cable gland for cables Ø 6 ... 12 mm
...	.....
<b>K50</b>	M12 metal connector, 5-pole
...	.....

For the complete list of possible combinations please contact our technical department.

Mechanical delay	
	short knob, 20 s (standard)
<b>C10</b>	short knob, 10 s
<b>L05</b>	long knob, 5 s
<b>L10</b>	long knob, 10 s
<b>L20</b>	long knob, 20 s

Threaded conduit entry	
<b>M2</b>	M20x1.5 (standard)
	PG 13.5

Actuators	
	without actuator (standard)
<b>F</b>	straight actuator VF KEYF
<b>F1</b>	angled actuator VF KEYF1
<b>F2</b>	jointed actuator VF KEYF2
<b>F3</b>	jointed actuator adjustable in two directions VF KEYF3
<b>F7</b>	jointed actuator adjustable in one direction VF KEYF7
<b>F8</b>	universal actuator VF KEYF8

Contact type	
	silver contacts (standard)
<b>G</b>	silver contacts with 1 µm gold coating
<b>G1</b>	silver contacts, 2.5 µm gold coating (not for contact blocks 20, 21, 22, 33, 34)

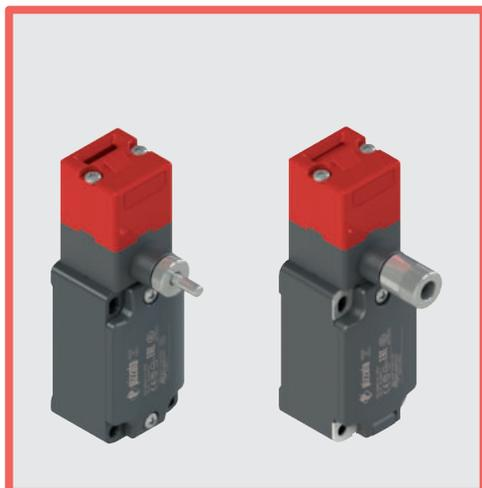

### Main features

- Metal housing or technopolymer housing, one conduit entry
- Protection degree IP67
- 8 contact blocks available
- 6 stainless steel actuators available
- Versions with assembled M12 connector
- Versions with gold-plated silver contacts
- Strong actuator locking (1000 N)
- Manual actuator release
- Versions with different release delay times

### Quality marks:



IMQ approval:	EG605
UL approval:	E131787
CCC approval:	2007010305230000
EAC approval:	RU C-IT.YT03.B.00035/19

### Technical data

#### Housing

FP series housing made of glass fibre reinforced technopolymer, self-extinguishing, shock-proof and with double insulation:   
 FD series: metal housing, baked powder coating.  
 One threaded conduit entry: M20x1.5 (standard)  
 Protection degree: IP67 acc. to EN 60529 with cable gland of equal or higher protection degree

#### General data

SIL (SIL CL) up to: SIL 3 acc. to EN 62061  
 Performance Level (PL) up to: PL e acc. to EN ISO 13849-1  
 Interlock with mechanical lock, coded: type 2 acc. to EN ISO 14119  
 Coding level: low acc. to EN ISO 14119  
 Safety parameters:  
 $B_{10D}$ : 1,000,000 for NC contacts  
 Mission time: 20 years  
 Ambient temperature: -25°C ... +80°C (standard)  
 -40°C ... +80°C (T6 option)  
 Max. actuation frequency: 360 operating cycles/hour  
 Mechanical endurance: 500,000 operating cycles  
 Max. actuation speed: 0.5 m/s  
 Min. actuation speed: 1 mm/s  
 Maximum force before breakage  $F_{1max}$ : 1000 N acc. to EN ISO 14119  
 Max. holding force  $F_{Zh}$ : 770 N acc. to EN ISO 14119  
 Max. clearance of the actuator: 4.5 mm  
 Tightening torques for installation: see page 339  
 Wire cross-sections and wire stripping lengths: see page 357

#### In compliance with standards:

IEC 60947-5-1, IEC 60947-1, IEC 60204-1, EN ISO 14119, EN ISO 12100, IEC 60529, EN 50581, BG-GS-ET-15, UL 508, CSA 22.2 No.14

#### Approvals:

EN 60947-5-1, UL 508, CSA 22.2 No.14, GB/T14048.5-2017.

#### Compliance with the requirements of:

Machinery Directive 2006/42/EC, EMC Directive 2014/30/EU, RoHS Directive 2011/65/EU.

#### Positive contact opening in conformity with standards:

IEC 60947-5-1, EN 60947-5-1.

 If not expressly indicated in this chapter, for correct installation and utilization of all articles see the instructions given on pages 337 to 350.

### Electrical data

### Utilization category

without connector	Thermal current ( $I_{th}$ ):	10 A	Utilization category
without connector	Rated insulation voltage (U):	500 Vac 600 Vdc 400 Vac 500 Vdc (contact blocks 20, 21, 22, 33, 34)	Alternating current: AC15 (50±60 Hz) U <sub>e</sub> (V) 250 400 500 I <sub>e</sub> (A) 6 4 1
	Rated impulse withstand voltage (U <sub>imp</sub> ):	6 kV 4 kV (contact blocks 20, 21, 22, 33, 34)	Direct current: DC13 U <sub>e</sub> (V) 24 125 250 I <sub>e</sub> (A) 3 0.55 0.3
	Conditional short circuit current: Protection against short circuits: Pollution degree:	1000 A acc. to EN 60947-5-1 type aM fuse 10 A 500 V 3	
with M12 connector, 4 and 5-pole	Thermal current ( $I_{th}$ ):	4 A	Utilization category
	Rated insulation voltage (U):	250 Vac 300 Vdc	Alternating current: AC15 (50±60 Hz) U <sub>e</sub> (V) 24 120 250 I <sub>e</sub> (A) 4 4 4
	Protection against short circuits: Pollution degree:	type gG fuse 4 A 500 V 3	Direct current: DC13 U <sub>e</sub> (V) 24 125 250 I <sub>e</sub> (A) 3 0.55 0.3
with M12 connector, 8-pole	Thermal current ( $I_{th}$ ):	2 A	Utilization category
	Rated insulation voltage (U):	30 Vac 36 Vdc	Alternating current: AC15 (50±60 Hz) U <sub>e</sub> (V) 24 I <sub>e</sub> (A) 2
	Protection against short circuits: Pollution degree:	type gG fuse 2 A 500 V 3	Direct current: DC13 U <sub>e</sub> (V) 24 I <sub>e</sub> (A) 2



## Features approved by IMQ

Rated insulation voltage ( $U_i$ ):	500 Vac
Conventional free air thermal current ( $I_{th}$ ):	400 Vac (for contact blocks 20, 21, 22, 33, 34)
Protection against short circuits:	type aM fuse 10 A 500 V
Rated impulse withstand voltage ( $U_{imp}$ ):	6 kV
	4 kV (for contact blocks 20, 21, 22, 33, 34)
Protection degree of the housing:	IP67
MV terminals (screw terminals)	
Pollution degree:	3
Utilization category:	AC15
Operating voltage ( $U_e$ ):	400 Vac (50 Hz)
Operating current ( $I_a$ ):	3 A

Forms of the contact element: Zb, Y+Y, Y+Y+X, Y+Y+Y, Y+X+X  
 Positive opening contacts on contact blocks 6, 7, 9, 20, 21, 22, 33, 34  
 In compliance with standards: EN 60947-1, EN 60947-5-1, fundamental requirements of the Low Voltage Directive 2014/35/EU.

Please contact our technical department for the list of approved products.

## Features approved by UL

Electrical Ratings:	Q300 pilot duty (69 VA, 125-250 V dc) A600 pilot duty (720 VA, 120-600 V ac)
Environmental Ratings:	Types 1, 4X, 12, 13
	Use 60 or 75 °C copper (Cu) conductor and wire size range 12, 14 AWG, stranded or solid. The terminal tightening torque of 7.1 lb in (0.8 Nm).
	For FP series: the hub is to be connected to the conduit before the hub is connected to the enclosure.

Please contact our technical department for the list of approved products.

## Description



These switches are used on machines where the hazardous conditions remain for a while, even after the machine has been switched off, for example because of mechanical inertia of the pulleys, saw disks, mills. This switch has its ideal application where the guard is not opened frequently and the installation of a switch with solenoid would be too expensive.

These switches are considered interlocks with guard locking in accordance with ISO 14119, and the product is marked on the side with the symbol shown.

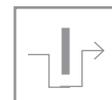

## Head and knobs with variable orientation

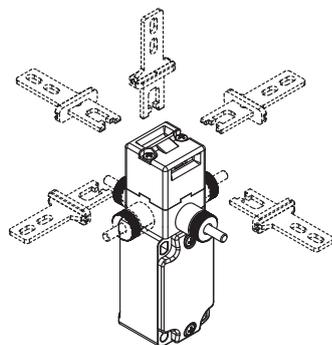

The head can be quickly turned to each of the four sides of the switch by unfastening the two fastening screws.

The mechanical delay device can be rotated in 90° steps as well. This enables the switch to assume 32 different configurations.

## Adjustment range

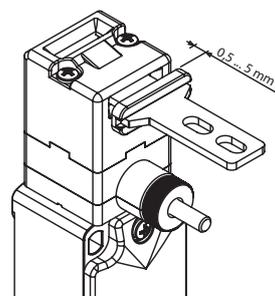

The actuation head of this switch features a wide range of travel. In this way the guard can oscillate along the direction of insertion (4.5 mm) without causing unwanted machine shutdowns. This wide range of travel is available in all actuators in order to ensure maximum device reliability.

## Protection degree IP67

**IP67** These devices are designed to be used in the toughest environmental conditions and they pass the IP67 immersion test acc. to EN 60529. They can therefore be used in all environments where maximum protection degree of the housing is required.

## Contact block



Contact blocks with captive screws, finger protection, twin bridge contacts and double interruption for higher contact reliability. Available in multiple versions with shifted, simultaneous or overlapping actuation paths. They are suitable for many different applications.

## Holding force of the unlocked actuator

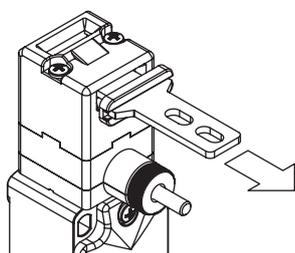

The inside of each switch features a device which holds the actuator in its closed position. Ideal for all those applications where several guards are unlocked simultaneously, but only one is actually opened. The device keeps all the unlocked guards in their position with a retaining force of approx. 30 N, stopping any vibrations or gusts of wind from opening them.

## Extended temperature range

**-40°C**

These devices are also available in a special version suitable for an ambient operating temperature range from -40°C up to +80°C.

They can therefore be used for applications in cold stores, sterilisers and other equipment with low temperature environments. The special materials used to produce these versions retain their characteristics even under these conditions, thereby expanding the installation possibilities.

## Laser engraving



All devices are marked using a dedicated indelible laser system. These engravings are therefore suitable for extreme environments too. Thanks to this system that does not use labels, the loss of plate data is prevented and a greater resistance of the marking is achieved over time.

## Safety screws for actuators

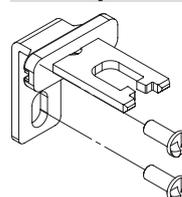

As required by EN ISO 14119, the actuator must be fixed immovably to the guard frame. Pan head safety screws with one-way fitting are available for this purpose. With this screw type, the actuators cannot be removed or tampered by using common tools. See accessories on page 332.

**Operation (FP 6R2-M2F1)**

The switch is fastened to the machine body (A), while the stainless steel actuator is fastened to the guard (B). Once installed, the switch will firmly lock the actuator. In order to remove the actuator, the knob (C) has to be rotated. On the first turns the electrical contacts will positively open, then, after about 20 seconds (or 10 seconds depending on the version), the actuator will be released. In order to close the guard, the knob must be rotated in the opposite direction. This switch doesn't need power supply or timer and can be easily installed on old machines without important changes in their electrical circuit. The knob (C) may be supplied in a short (standard) or in a long version.

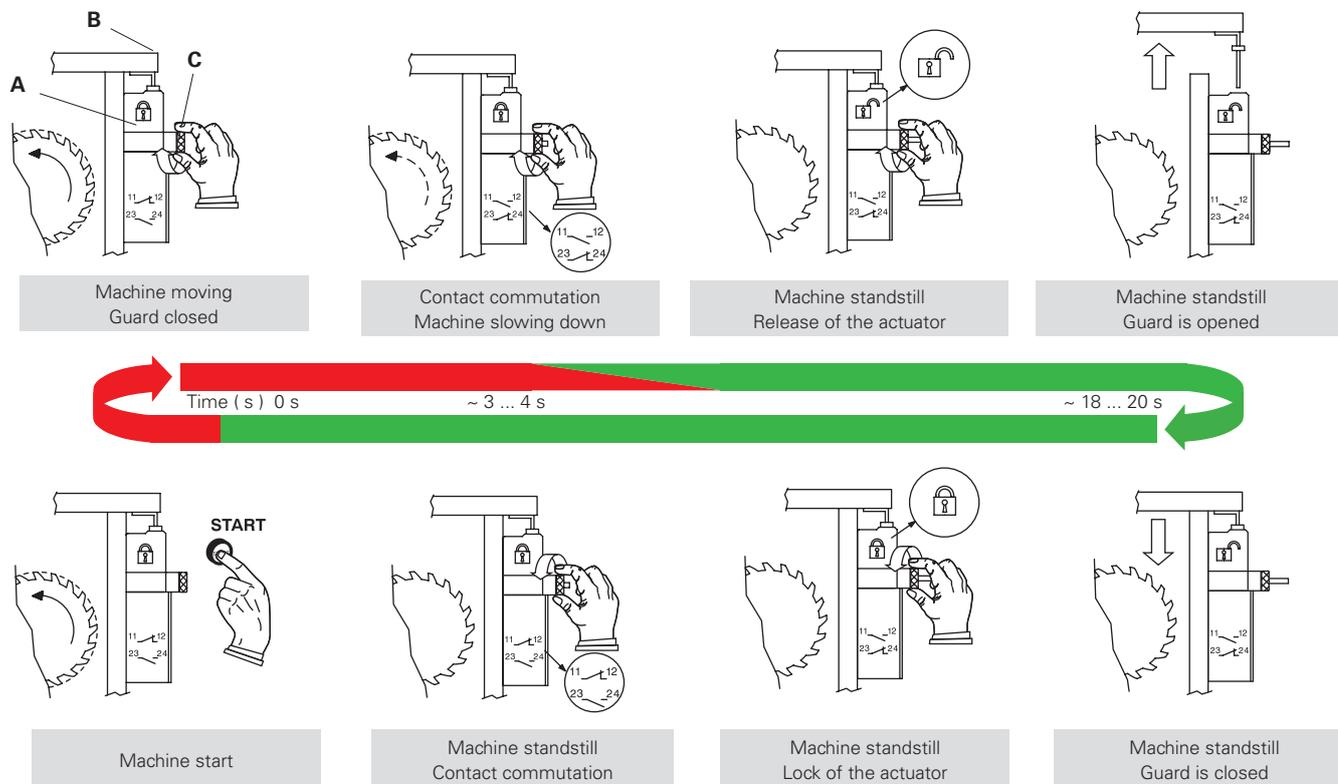
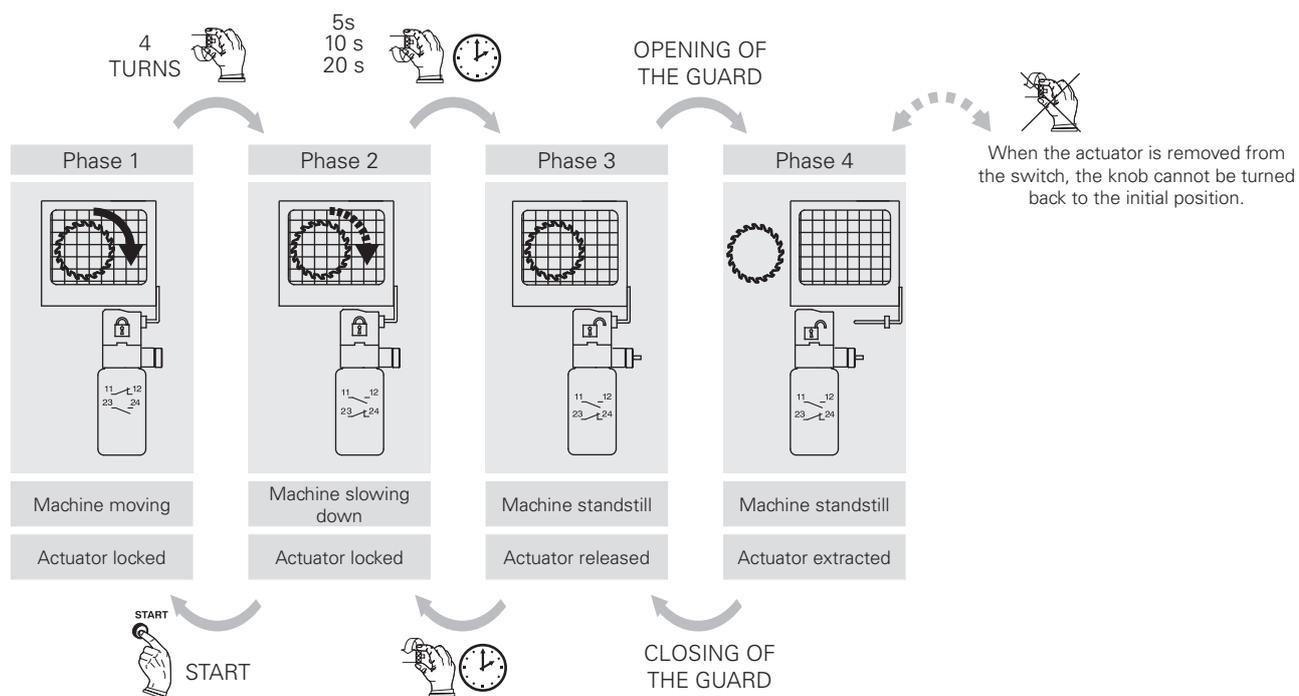
**Operating phases (FD 6R2-M2F1)**





	Technopolymer housing Without actuator	Metal housing Without actuator	Metal housing Without actuator
Contact type: <b>L</b> = slow action <b>LO</b> = slow action, make before break			
Contact blocks 6 <b>L</b> FP 6R2-M2   1NO+1NC  7 <b>LO</b> FP 7R2-M2   1NO+1NC  9 <b>L</b> FP 9R2-M2   2NC  20 <b>L</b> FP 20R2-M2   1NO+2NC  21 <b>L</b> FP 21R2-M2   3NC  22 <b>L</b> FP 22R2-M2   2NO+1NC  33 <b>L</b> FP 33R2-M2   1NO+1NC  34 <b>L</b> FP 34R2-M2   2NC  Actuating force 10 N (18 N )	6 <b>L</b> FD 6R2-M2   1NO+1NC  7 <b>LO</b> FD 7R2-M2   1NO+1NC  9 <b>L</b> FD 9R2-M2   2NC  20 <b>L</b> FD 20R2-M2   1NO+2NC  21 <b>L</b> FD 21R2-M2   3NC  22 <b>L</b> FD 22R2-M2   2NO+1NC  33 <b>L</b> FD 33R2-M2   1NO+1NC  34 <b>L</b> FD 34R2-M2   2NC  Actuating force 10 N (18 N )	6 <b>L</b> FD 6R2-L10M2   1NO+1NC  7 <b>LO</b> FD 7R2-L10M2   1NO+1NC  9 <b>L</b> FD 9R2-L10M2   2NC  20 <b>L</b> FD 20R2-L10M2   1NO+2NC  21 <b>L</b> FD 21R2-L10M2   3NC  22 <b>L</b> FD 22R2-L10M2   2NO+1NC  33 <b>L</b> FD 33R2-L10M2   1NO+1NC  34 <b>L</b> FD 34R2-L10M2   2NC  Actuating force 10 N (18 N )	

All values in the diagrams are in turns of the knob

Legend: With positive opening according to EN 60947-5-1, interlock with lock monitoring acc. to EN ISO 14119

### How to read travel diagrams

All values in the diagrams are in turns of the knob

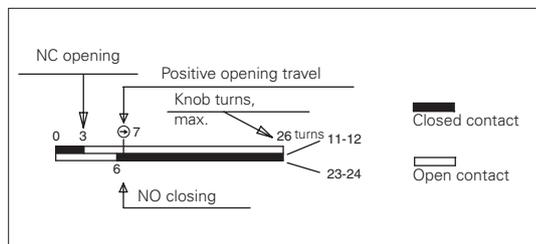

#### IMPORTANT:

The state of the NC contact refers to the switch with inserted actuator and with the knob turned anti-clockwise up to the end of the travel. For installation in safety applications, actuate the switch at least up to the positive opening travel shown in the travel diagrams with symbol . Actuate the switch at least with the positive opening force, reported in brackets below each article, next to the actuating force value.

### Limits of use

Do not use where dust and dirt may penetrate in any way into the head and deposit there. Especially not where powder, shavings, concrete or chemicals are sprayed. Adhere to the EN ISO 14119 requirements regarding low level of coding for interlocks. Do not use in environments with presence of explosive or flammable gas. In these case use ATEX products (see dedicated Pizzato catalogue).

Attention! These switches alone are not suitable for applications where operators may physically enter the dangerous area, because an eventual closing of the door behind them could restart the machine operation. In these cases, the maintenance personnel must use the actuator entry locking device VF KB1 shown on page 98.

**Stainless steel actuators****IMPORTANT:** These actuators can be used only with items of the FD, FP, FL, FC and FS series (e.g. FD 6R2-M2).

Low level of coding acc. to EN ISO 14119.

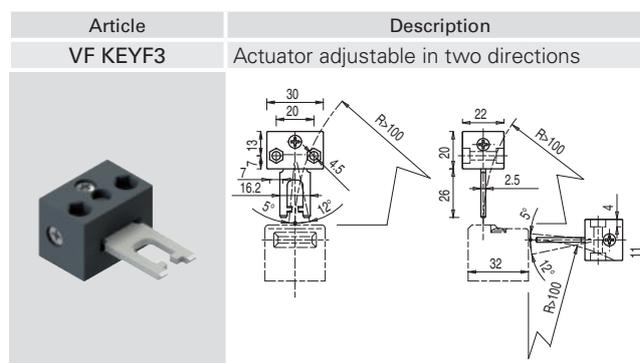
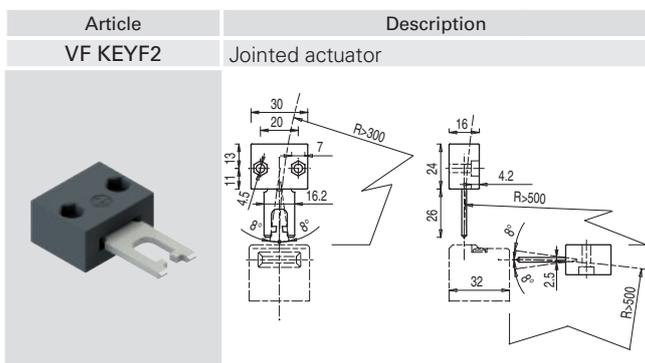
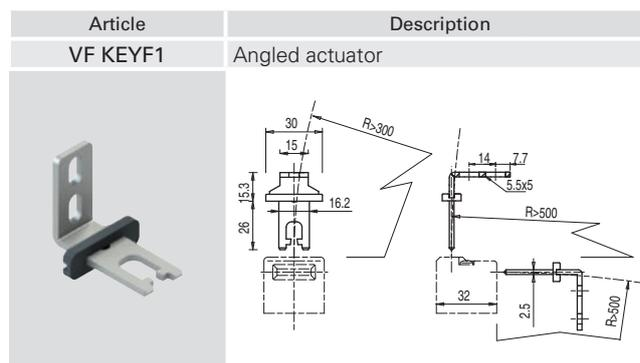
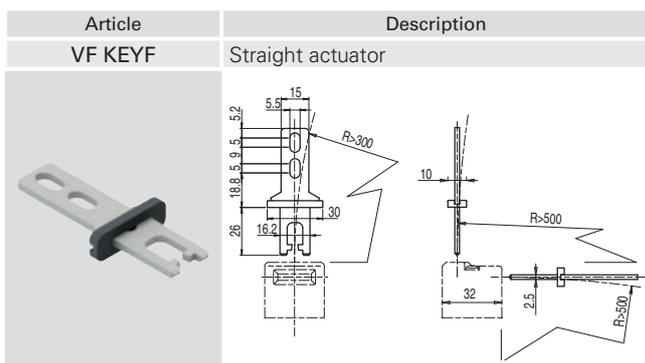

The actuator can flex in four directions for applications where the guard alignment is not precise.

Actuator adjustable in two directions for guards with reduced dimensions.

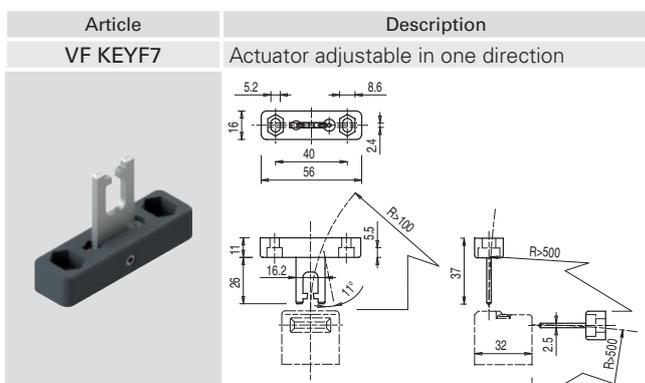

Actuator adjustable in one direction for guards with reduced dimensions.



### Universal actuator VF KEYF8

**IMPORTANT:** These actuators can be used only with items of the FD, FP, FL, FC and FS series (e.g. FD 6R2-M2).  
Low level of coding acc. to EN ISO 14119.

Article	Description
VF KEYF8	Universal actuator

Jointed actuator for guards with poor alignment, adjustable in two dimensions for small doors; can be mounted in various positions. The metal fixing body has two pairs of bore holes; it is provided for rotating the working plane of the actuator by 90°.

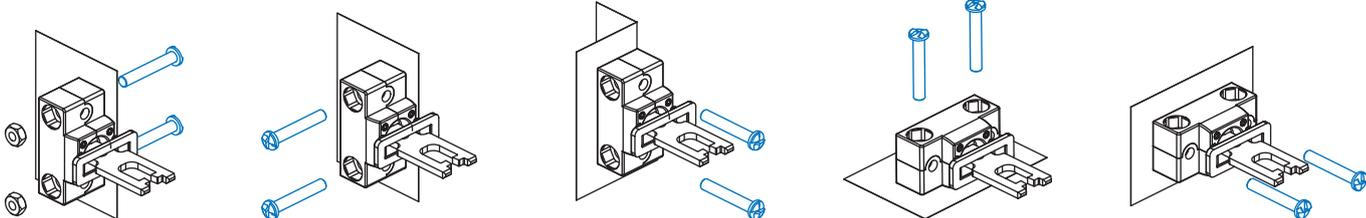
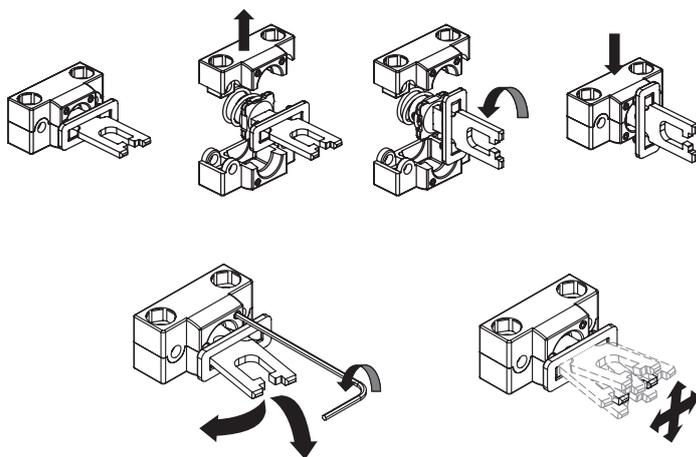

### Accessories

Article	Description
VF KB1	Lock out device



Padlockable lock out device to prevent the actuator entry and the accidental closing of the door behind operators while they are in the danger area.  
Hole diameter for padlocks: 9 mm.



Selection diagram

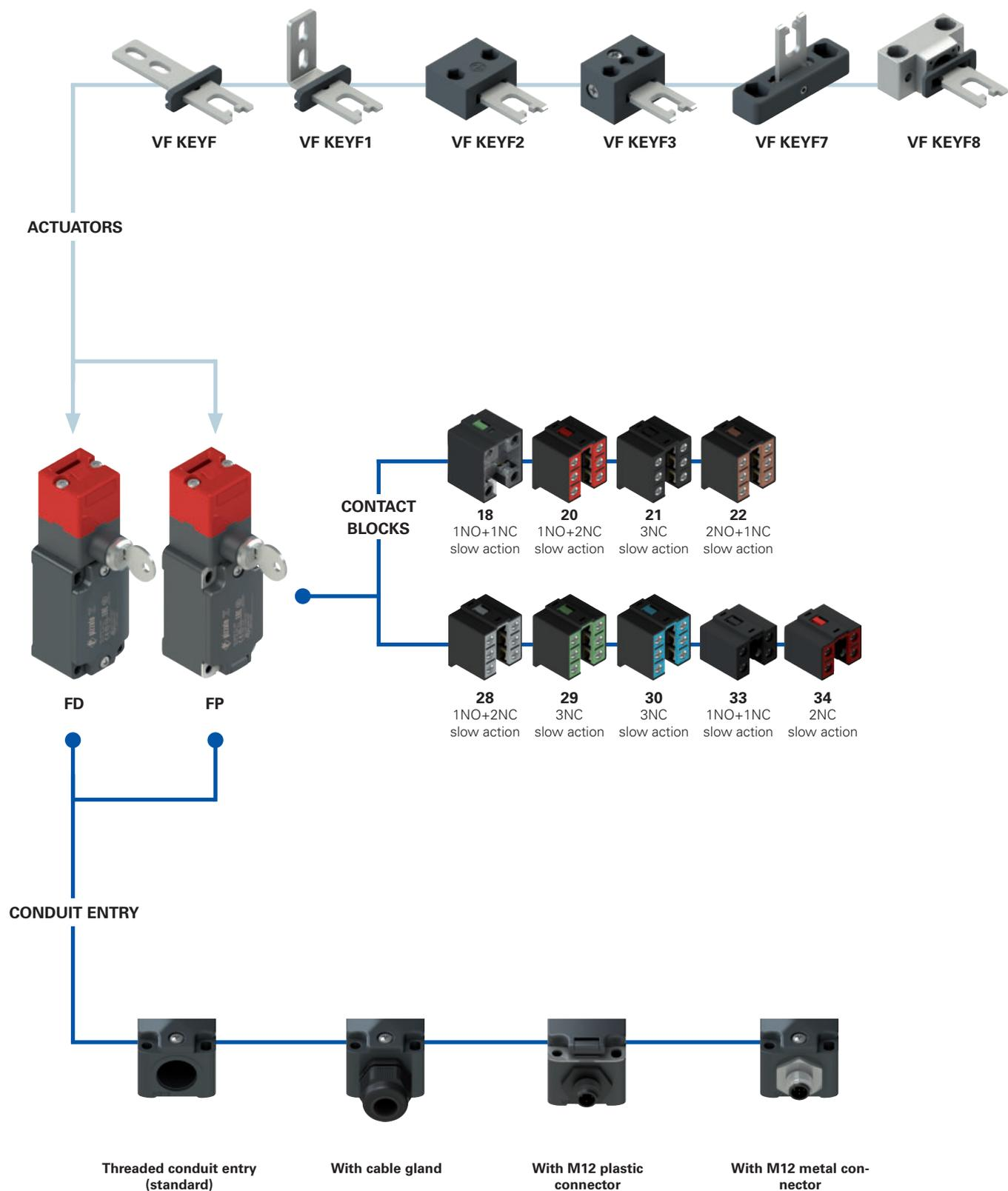



### Code structure

**Attention!** The feasibility of a code number does not mean the effective availability of a product. Please contact our sales office.

article options options  
**FD 1899-F1GM2K50T6V200**

Housing	
<b>FD</b>	metal, one conduit entry
<b>FP</b>	technopolymer, one conduit entry

Lock key coding	
	one standard key coding (371)
<b>V200</b>	up to 8 different key codings

Contact blocks		
	Contacts activated by the lock	Contacts activated by actuator extraction
<b>18</b>	1NO+1NC	
<b>20</b>	1NO+2NC	
<b>21</b>	3NC	
<b>22</b>	2NO+1NC	
<b>28</b>	1NO+1NC	1NC
<b>29</b>	2NC	1NC
<b>30</b>	1NC	2NC
<b>33</b>	1NO+1NC	
<b>34</b>	2NC	

Ambient temperature	
	-25°C ... +80°C (standard)
<b>T6</b>	-40°C ... +80°C

Pre-installed cable glands or connectors	
	no cable gland or connector (standard)
<b>K23</b>	cable gland for cables Ø 6 ... 12 mm
...	.....
<b>K50</b>	M12 metal connector, 5-pole
...	.....

For the complete list of possible combinations please contact our technical department.

Actuators	
	without actuator (standard)
<b>F</b>	straight actuator VF KEYF
<b>F1</b>	angled actuator VF KEYF1
<b>F2</b>	jointed actuator VF KEYF2
<b>F3</b>	jointed actuator adjustable in two directions VF KEYF3
<b>F7</b>	jointed actuator adjustable in one direction VF KEYF7
<b>F8</b>	universal actuator VF KEYF8

Threaded conduit entry	
<b>M2</b>	M20x1.5 (standard)
	PG 13.5

Contact type	
	silver contacts (standard)
<b>G</b>	silver contacts with 1 µm gold coating
<b>G1</b>	silver contacts, 2.5 µm gold coating (not for contact blocks 20, 21, 22, 28, 29, 30, 33, 34)

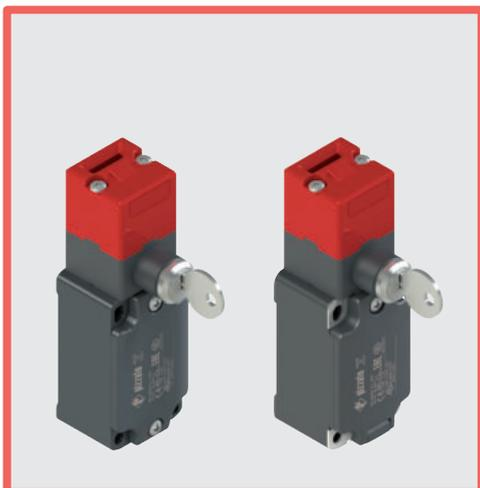

### Main features

- Metal housing or technopolymer housing, one conduit entry
- Protection degree IP67
- 9 contact blocks available
- 6 stainless steel actuators available
- Versions with assembled M12 connector
- Versions with gold-plated silver contacts
- Strong actuator locking (1000 N)
- Release of the actuator by key

### Quality marks:



IMQ approval:	EG605
UL approval:	E131787
CCC approval:	2007010305230000
EAC approval:	RU C-IT.YT03.B.00035/19

### Technical data

#### Housing

FP series housing made of glass fibre reinforced technopolymer, self-extinguishing, shock-proof and with double insulation:

FD series: metal housing, baked powder coating.

Metal head, baked epoxy powder coating.

One threaded conduit entry:

M20x1.5 (standard)

Protection degree:

IP67 acc. to EN 60529 with cable gland of equal or higher protection degree

#### General data

SIL (SIL CL) up to:

SIL 3 acc. to EN 62061

Performance Level (PL) up to:

PL e acc. to EN ISO 13849-1

Interlock with mechanical lock, coded:

type 2 acc. to EN ISO 14119

Coding level:

low acc. to EN ISO 14119

Safety parameters:

$B_{10D}$ :

1,000,000 for NC contacts

Mission time:

20 years

Ambient temperature:

-25°C ... +80°C (standard)  
-40°C ... +80°C (T6 option)

Max. actuation frequency:

3600 operating cycles/hour

Mechanical endurance:

500,000 operating cycles

Max. actuation speed:

0.5 m/s

Min. actuation speed:

1 mm/s

Maximum force before breakage  $F_{1max}$ :

1000 N acc. to EN ISO 14119

Max. holding force  $F_{Zh}$ :

770 N acc. to EN ISO 14119

Max. clearance of the actuator:

4.5 mm

Actuator extraction force:

30 N

Tightening torques for installation:

see page 339

Wire cross-sections and

wire stripping lengths:

see page 357

#### In compliance with standards:

IEC 60947-5-1, IEC 60947-1, IEC 60204-1, EN ISO 14119, EN ISO 12100, IEC 60529, EN 50581, BG-GS-ET-15, UL 508, CSA 22.2 No.14.

#### Approvals:

EN 60947-5-1, UL 508, CSA 22.2 No.14, GB/T14048.5-2017.

#### Compliance with the requirements of:

Machinery Directive 2006/42/EC, EMC Directive 2014/30/EU, RoHS Directive 2011/65/EU.

#### Positive contact opening in conformity with standards:

IEC 60947-5-1, EN 60947-5-1.

**⚠ If not expressly indicated in this chapter, for correct installation and utilization of all articles see the instructions given on pages 337 to 350.**

### Electrical data

### Utilization category

	Electrical data	Utilization category
without connector	Thermal current ( $I_{th}$ ):	10 A
	Rated insulation voltage ( $U_i$ ):	500 Vac 600 Vdc 400 Vac 500 Vdc (contact blocks 20, 21, 22, 28, 29, 30, 33, 34)
	Rated impulse withstand voltage ( $U_{imp}$ ):	6 kV 4 kV (contact blocks 20, 21, 22, 28, 29, 30, 33, 34)
with M12 connector, 4 and 5-pole	Conditional short circuit current:	1000 A acc. to EN 60947-5-1
	Protection against short circuits:	type aM fuse 10 A 500 V
	Pollution degree:	3
with M12 connector, 8-pole	Thermal current ( $I_{th}$ ):	4 A
	Rated insulation voltage ( $U_i$ ):	250 Vac 300 Vdc type gG fuse 4 A 500 V
	Protection against short circuits:	3
with M12 connector, 8-pole	Thermal current ( $I_{th}$ ):	2 A
	Rated insulation voltage ( $U_i$ ):	30 Vac 36 Vdc type gG fuse 2 A 500 V
	Protection against short circuits:	3
		Alternating current: AC15 (50±60 Hz)
		$U_e$ (V) 250 400 500
		$I_e$ (A) 6 4 1
		Direct current: DC13
		$U_e$ (V) 24 125 250
		$I_e$ (A) 3 0.55 0.3
		Alternating current: AC15 (50±60 Hz)
		$U_e$ (V) 24 120 250
		$I_e$ (A) 4 4 4
		Direct current: DC13
		$U_e$ (V) 24 125 250
		$I_e$ (A) 3 0.55 0.3
		Alternating current: AC15 (50±60 Hz)
		$U_e$ (V) 24
		$I_e$ (A) 2
		Direct current: DC13
		$U_e$ (V) 24
		$I_e$ (A) 2



## Features approved by IMQ

Rated insulation voltage (U <sub>i</sub> ):	500 Vac 400 Vac (for contact blocks 20, 21, 22, 33, 34)
Conventional free air thermal current (I <sub>th</sub> ):	10 A
Protection against short circuits:	type aM fuse 10 A 500 V
Rated impulse withstand voltage (U <sub>imp</sub> ):	6 kV 4 kV (for contact blocks 20, 21, 22, 33, 34)
Protection degree of the housing:	IP67
MV terminals (screw terminals)	
Pollution degree:	3
Utilization category:	AC15
Operating voltage (U <sub>e</sub> ):	400 Vac (50 Hz)
Operating current (I <sub>e</sub> ):	3 A
Forms of the contact element:	Zb, Y+Y, Y+Y+X, Y+Y+Y, Y+X+X
Positive opening contacts on contact blocks	18, 20, 21, 22, 28, 29, 30
In compliance with standards:	EN 60947-1, EN 60947-5-1, fundamental requirements of the Low Voltage Directive 2014/35/EU.

Please contact our technical department for the list of approved products.

## Features approved by UL

Electrical Ratings:	Q300 pilot duty (69 VA, 125-250 V dc) A600 pilot duty (720 VA, 120-600 V ac)
Environmental Ratings:	Types 1, 4X, 12, 13
Use 60 or 75 °C copper (Cu) conductor and wire size range 12, 14 AWG, stranded or solid. The terminal tightening torque of 7.1 lb in (0.8 Nm).	
For FP series: the hub is to be connected to the conduit before the hub is connected to the enclosure.	

Please contact our technical department for the list of approved products.

## Description



This type of switches is applied on fences or guards where entrance is allowed to authorized personnel only. They have been designed to control large protected areas where operators may physically enter. Supplied with a strong lock, the actuator can be removed from the head only after a complete rotation (180°) of the locking key. The electrical contacts are switched as the key is turned; the actuator is released only after the NC contacts have been positively opened. Contacts activated by the lock are reset to the initial position only with inserted actuator and with the key in the locking position. It is impossible to rotate the key when the key locking device is unlocked and the actuator is removed (C state). These switches are considered interlocks with guard locking in accordance with ISO 14119, and the product is marked on the side with the symbol shown.

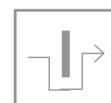

## Head and release devices with variable orientation

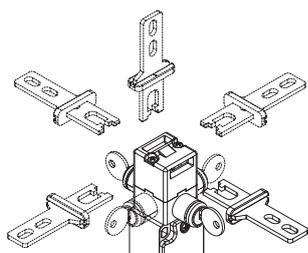

The head can be quickly turned to each of the four sides of the switch by unfastening the two fastening screws.

The auxiliary key release device can be rotated in 90° steps as well. This enables the switch to assume 32 different configurations.

## Adjustment range

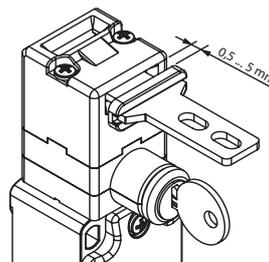

The actuation head of this switch features a wide range of travel. In this way the guard can oscillate along the direction of insertion (4.5 mm) without causing unwanted machine shutdowns. This wide range of travel is available in all actuators in order to ensure maximum device reliability.

## Protection degree IP67

**IP67** These devices are designed to be used in the toughest environmental conditions and they pass the IP67 immersion test acc. to EN 60529. They can therefore be used in all environments where maximum protection degree of the housing is required.

## Contact block



Contact blocks with captive screws, finger protection, twin bridge contacts and double interruption for higher contact reliability.

## Holding force of the unlocked actuator

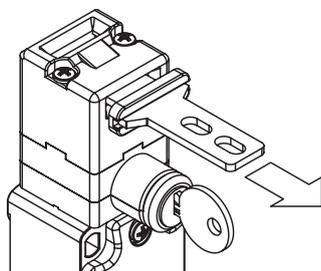

The inside of each switch features a device which holds the actuator in its closed position. Ideal for all those applications where several guards are unlocked simultaneously, but only one is actually opened. The device keeps all the unlocked guards in their position with a retaining force of approx. 30 N, stopping any vibrations or gusts of wind from opening them.

## Extended temperature range

**-40°C**

These devices are also available in a special version suitable for an ambient operating temperature range from -40°C up to +80°C.

They can therefore be used for applications in cold stores, sterilisers and other equipment with low temperature environments. The special materials used to produce these versions retain their characteristics even under these conditions, thereby expanding the installation possibilities.

## Laser engraving



All devices are marked using a dedicated indelible laser system. These engravings are therefore suitable for extreme environments too. Thanks to this system that does not use labels, the loss of plate data is prevented and a greater resistance of the marking is achieved over time.

## Safety screws for actuators

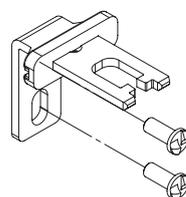

As required by ISO 14119, the actuator must be fixed immovably to the guard frame. Pan head safety screws with one-way fitting are available for this purpose. With this screw type, the actuators cannot be removed or tampered by using common tools. See accessories on page 332.

## Operation

The switch is fastened to the machine body (A), while the stainless steel actuator is fastened to the guard (B). Once installed, the switch will firmly lock the actuator. To remove the actuator, the lock must be unlocked by turning the key (C). When the actuator is removed, the key cannot be put into the initial position anymore. The example shows how the contacts of the lock and actuator are switched and how the switch can be installed within the machine in such a way that only the release device is visible from the outside.

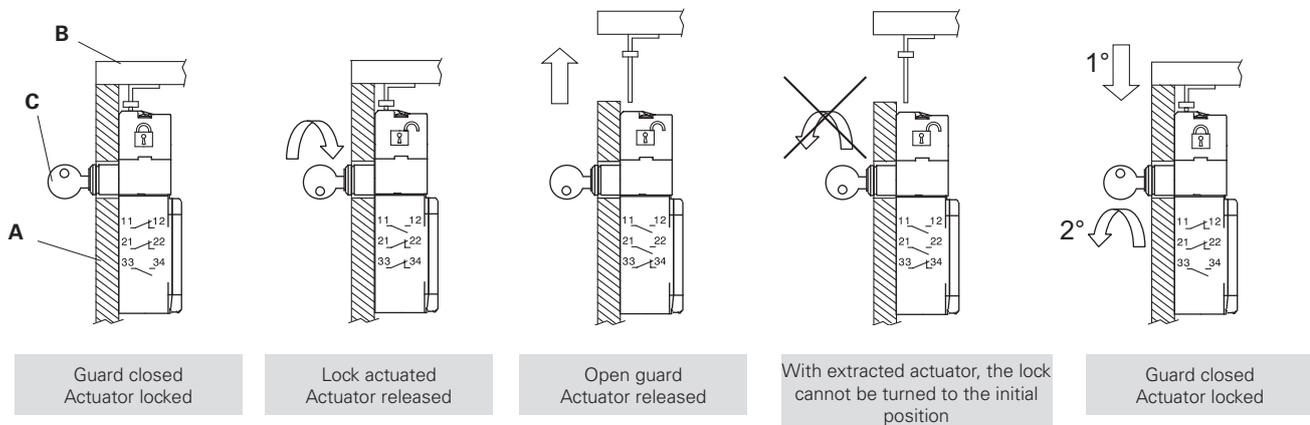

## Operating phases

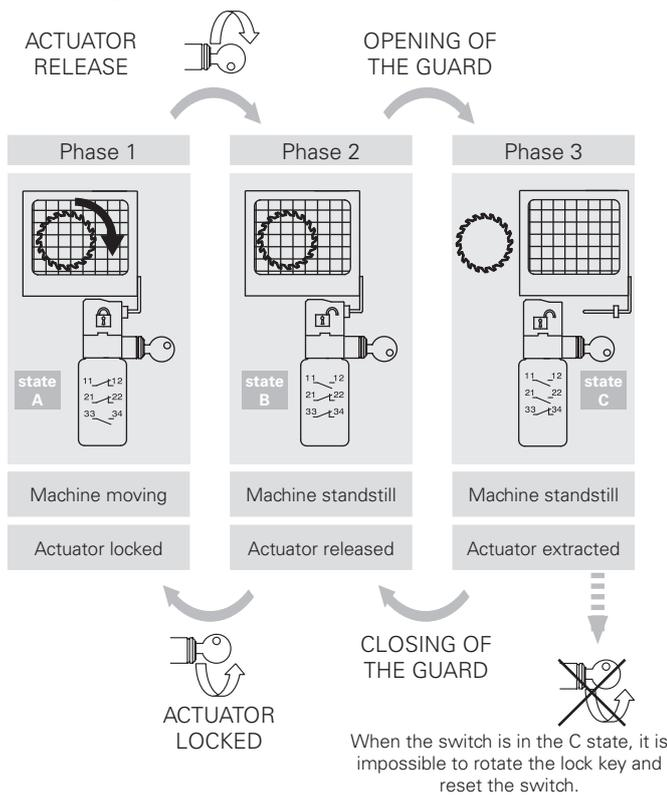

## Contact positions related to switch states

Operating state	state A	state B	state C
Actuator	Inserted and locked	Inserted and released	Extracted
Lock	Closed	Open	Open

Contact blocks	state A	state B	state C
FD 1899 1NO+1NC controlled by the lock			
FD 2099 1NO+2NC controlled by the lock			
FD 2199 3NC controlled by the lock			
FD 2299 2NO+1NC controlled by the lock			
FD 2899 1NO+1NC controlled by the lock 1NC controlled by the actuator			
FD 2999 2NC controlled by the lock 1NC controlled by the actuator			
FD 3099 1NC controlled by the lock 2NC controlled by the actuator			

The key can be extracted from the lock with locked or released actuator.

## Limits of use

Do not use where dust and dirt may penetrate in any way into the head and deposit there. Especially not where powder, shavings, concrete or chemicals are sprayed. Adhere to the ISO 14119 requirements regarding low level of coding for interlocks. Do not use in environments with presence of explosive or flammable gas. In these case use ATEX products (see dedicated Pizzato catalogue). Attention! These switches alone are not suitable for applications where operators may physically enter the dangerous area, because an eventual closing of the door behind them could restart the machine operation. In these cases the actuator entry locking device VF KB1 shown on page 106 must be used.





Contact type:	Technopolymer housing		Metal housing	
	Without actuator, supplied with two keys		Without actuator, supplied with two keys	
<b>L</b> = slow action				
Contact blocks				
18	<b>L</b>	FP 1899-M2   1NO+1NC	FD 1899-M2   1NO+1NC	
20	<b>L</b>	FP 2099-M2   1NO+2NC	FD 2099-M2   1NO+2NC	
21	<b>L</b>	FP 2199-M2   3NC	FD 2199-M2   3NC	
22	<b>L</b>	FP 2299-M2   2NO+1NC	FD 2299-M2   2NO+1NC	
28	<b>L</b>	FP 2899-M2   1NO+2NC	FD 2899-M2   1NO+2NC	
29	<b>L</b>	FP 2999-M2   3NC	FD 2999-M2   3NC	
30	<b>L</b>	FP 3099-M2   3NC	FD 3099-M2   3NC	
33	<b>L</b>	FP 3399-M2   1NO+1NC	FD 3399-M2   1NO+1NC	
34	<b>L</b>	FP 3499-M2   2NC	FD 3499-M2   2NC	
Actuating force		30 N (40 N )	30 N (40 N )	

Legend: With positive opening according to EN 60947-5-1, interlock with lock monitoring acc. to EN ISO 14119

### How to read travel diagrams

All values in the diagrams are in mm or in degrees

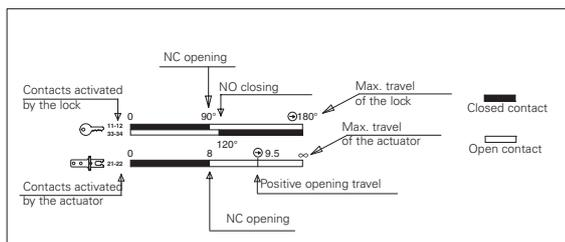

#### IMPORTANT:

The state of the NC contact () refers to the switch with inserted actuator and locked lock. In safety applications, actuate the switch at least up to the positive opening travel shown in the travel diagrams with symbol . Actuate the switch at least with the positive opening force, reported in brackets below each article, next to the actuating force value.

## Stainless steel actuators

**IMPORTANT:** These actuators can be used only with items of the FD, FP, FL, FC, and FS series (e.g. FD 1899-M2).  
Low level of coding acc. to EN ISO 14119.

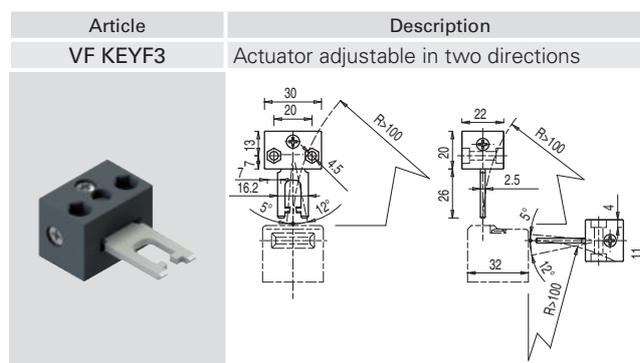
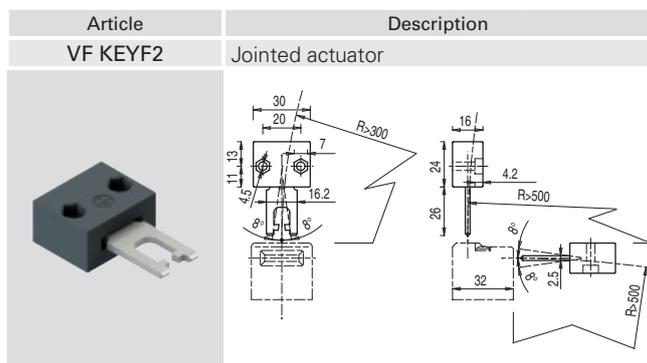
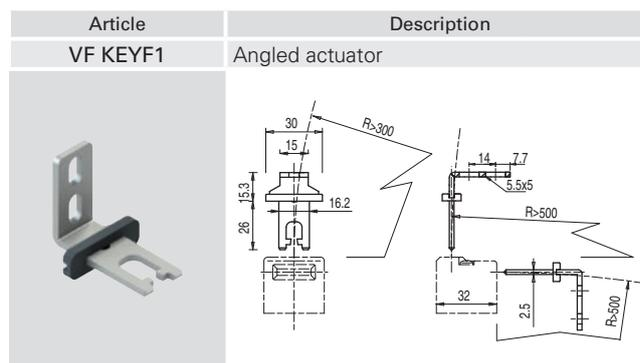
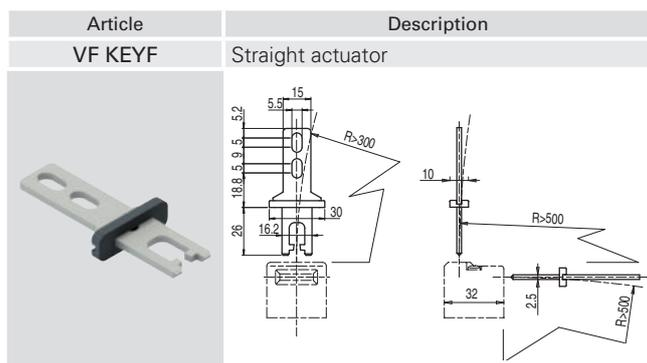

The actuator can flex in four directions for applications where the guard alignment is not precise.

Actuator adjustable in two directions for guards with reduced dimensions.

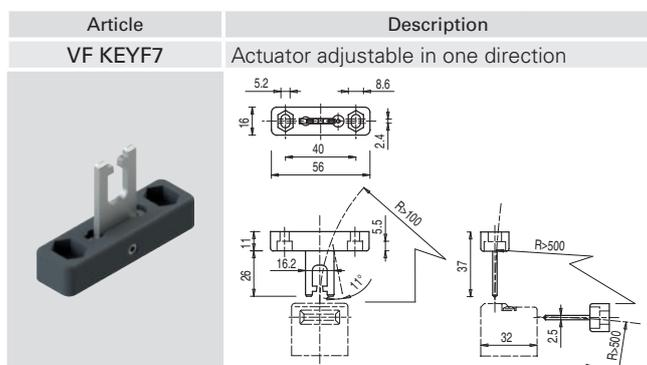

Actuator adjustable in one direction for guards with reduced dimensions.



### Universal actuator VF KEYF8

**IMPORTANT:** These actuators can be used only with items of the FD, FP, FL, FC, and FS series (e.g. FD 1899-M2).  
Low level of coding acc. to EN ISO 14119.

Article	Description
VF KEYF8	Universal actuator

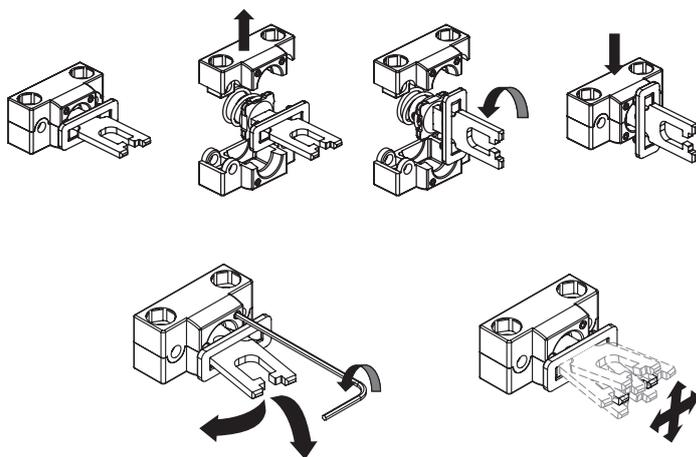
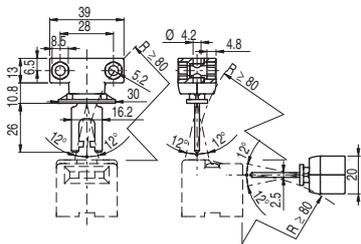
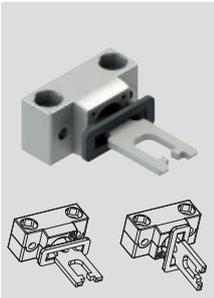

Jointed actuator for guards with poor alignment, adjustable in two dimensions for small doors; can be mounted in various positions. The metal fixing body has two pairs of bore holes; it is provided for rotating the working plane of the actuator by 90°.

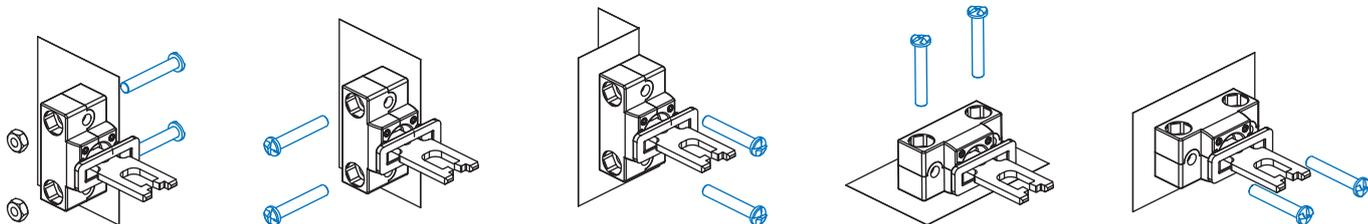

### Accessories

Article	Description
VF KB1	Lock out device

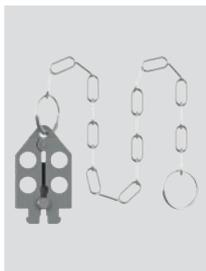

Padlockable lock out device to prevent the actuator entry and the accidental closing of the door behind operators while they are in the danger area.  
Hole diameter for padlocks: 9 mm.



Article	Description
VF KLA371	Set of two locking keys



Extra copy of the locking keys to be purchased if further keys are needed (standard supply: 2 units). The keys of all switches have the same code. Other codes on request.

## Description



These switches are used on machines where the hazardous conditions remain for a while, even after the machines have been switched off, for example because of mechanical inertia of pulleys, saw disks, parts under pressure or with high temperatures. Thus, the switches can also be used if individual guards are only to be opened under certain conditions.

The versions with solenoid actuated NC contacts are considered interlocks with locking in accordance with ISO 14119, and the product's label is marked with the symbol shown.

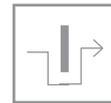

### Holding force of the locked actuator

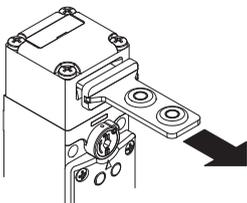

The strong interlocking system guarantees a maximum actuator holding force of  $F_{1max} = 2800 \text{ N}$ .

### Wide-ranging actuator travel

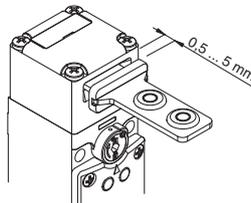

The actuation head of this switch features a wide range of travel. In this way the guard can oscillate along the direction of insertion (4.5 mm) without causing unwanted machine shutdowns. This wide range of travel is available in all actuators in order to ensure maximum device reliability.

### Heads and devices with variable orientation

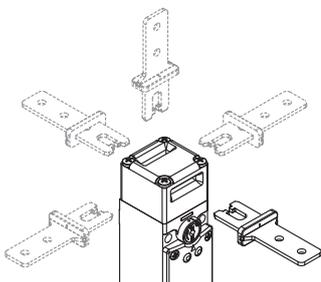

The system can be variably configured by loosening the 4 screws on the head.

The key release device and the release button can also be rotated and secured independently of one another in steps of  $90^\circ$ . The device can thus assume 32 different configurations.

### Contact blocks with 4 contacts



Innovative contact block with 4 contacts, available in various contact configurations for monitoring the actuator or the solenoid (patented). The unit is supplied with captive screws and self-lifting clamping plates. Removable finger protection for eyelet terminal.

High-reliability electrical contacts with 4 contact points and double interruption

### Safety screws for actuators

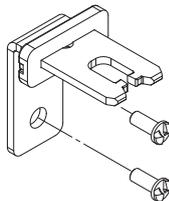

As required by EN ISO 14119, the actuator must be fixed immovably to the guard frame. Pan head safety screws with one-way fitting are available for this purpose. With this screw type, the actuators cannot be removed or tampered by using common tools. See accessories on page 332.

### Turnable key release with lock

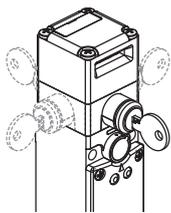

The auxiliary key release device is used to allow the maintenance or the entry into the machinery to authorized personnel only. Turning the key corresponds to actuating the solenoid: the actuator is released. The device can be turned, thereby enabling installation of the safety switch in the machine while the release device remains accessible on the outside of the guard.

### Escape release button

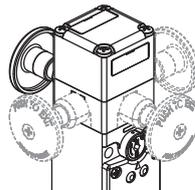

This device is used to safeguard a hazardous area that an operator may enter with his entire body. The release button, which is oriented towards the inside of the danger zone, allows the operator to escape even in the event of a power failure. Pushing the button results in the same function as the auxiliary release device. To reset the switch, simply return the button to its initial position. The escape release button can be rotated and is available with different lengths. It is fixed to the switch by means of a screw allowing the installation of the switch both inside and outside the guards.

### Key release device and escape release button

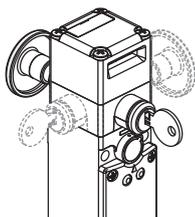

This device performs simultaneously the two functions mentioned above. The lock and button can be rotated in this case as well; the release button can be ordered with various lengths. The release button has priority over the lock, i.e., the emergency escape can be actuated to unlock the switch even if the lock is locked. To reset the switch, the lock and the button must be returned to their initial position.

### Non-detachable heads and release devices

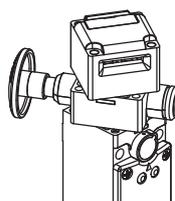

The head and the release device can be rotated but cannot be detached from each other. This makes the switch more secure since the problem of incorrect assembly by the installer cannot occur; in addition, the risk of damage is lower (loss of small parts, penetration of dirt, etc.).



### LED display unit, type A



In the version with LED display unit of type A, two green LEDs are switched-on directly by the power supply of the solenoid. Wiring is not necessary.

### LED display unit, types B and C



In the version with LED display unit of type B, connection wires from two LEDs are available, one green and one red. By means of suitable connections on the contact block, various operating states of the switch can be displayed externally.

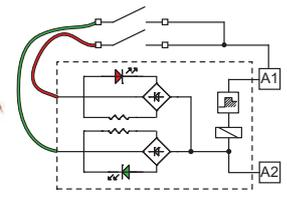

### Protection degree IP67

# IP67

These devices are designed to be used in the toughest environmental conditions and they pass the IP67 immersion test acc. to EN 60529. They can therefore be used in all environments where maximum protection degree of the housing is required.

### Three conduit entries

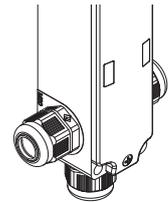

The switch is provided with three conduit entries in different directions. This allows its application in series connections or in narrow places.

### Extended temperature range

# -40°C

These devices are also available in a special version suitable for an ambient operating temperature range from -40°C up to +80°C.

They can therefore be used for applications in cold stores, sterilisers and other equipment with low temperature environments. The special materials used to produce these versions retain their characteristics even under these conditions, thereby expanding the installation possibilities.

### Sealable auxiliary release device



Switches with locked actuator with deactivated solenoid (function principle D) are equipped with an auxiliary release device for the solenoid to simplify installation of the switch and to facilitate entry into the danger zone in the event of a power failure. The auxiliary release

device acts on the switch exactly as if the solenoid was energised. As a result, it also actuates the electrical contacts. Can only be actuated with the use of two tools; this ensures adequate protection against tampering. If necessary, it can be sealed using the appropriate hole.

### Laser engraving



All FG series switches are permanently marked with a special laser system. As a result, the marking remains legible even under extreme operating conditions. Thanks to this system that does not use labels, the loss of plate data is prevented and a greater resistance of the marking is achieved over time.

### Access monitoring

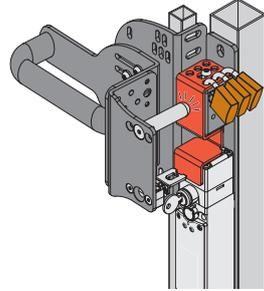

These safety switches alone do not provide sufficient personal protection to the operators or maintenance personnel in situations where they completely enter the danger zone, since unintentional closing of a door after entry could cause the machine to re-start. If the re-start release is completely dependent on these switches, a system for preventing this danger must be provided, e.g. a padlockable device for actuator entry locking VF KB2 (page 118) or a safety

handle, such as a P-KUBE 1 (page 159).

### Holding force of the unlocked actuator

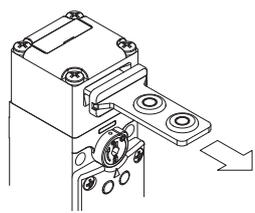

The inside of each switch features a device which holds the actuator in its closed position. Ideal for all those applications where several guards are unlocked simultaneously, but only one is actually opened. The device keeps all the unlocked guards in their position with a retaining force of approx. 30 N, stopping any vibrations or gusts of wind from opening them.

### LED signalling lights



Thanks to the three threaded cable entries, the high luminosity LED signalling lights of the VF SL series can be installed on the switch.

The LED signalling lights can be easily installed by screwing them on one of the conduit entries not used for electric cables. They can be used for many different purposes: for example, to signal, from a distance, whether the switch has been actuated; whether the guard has closed correctly; or whether the guard is locked or unlocked.

For more information see chapter Accessories, page 321.

Selection diagram

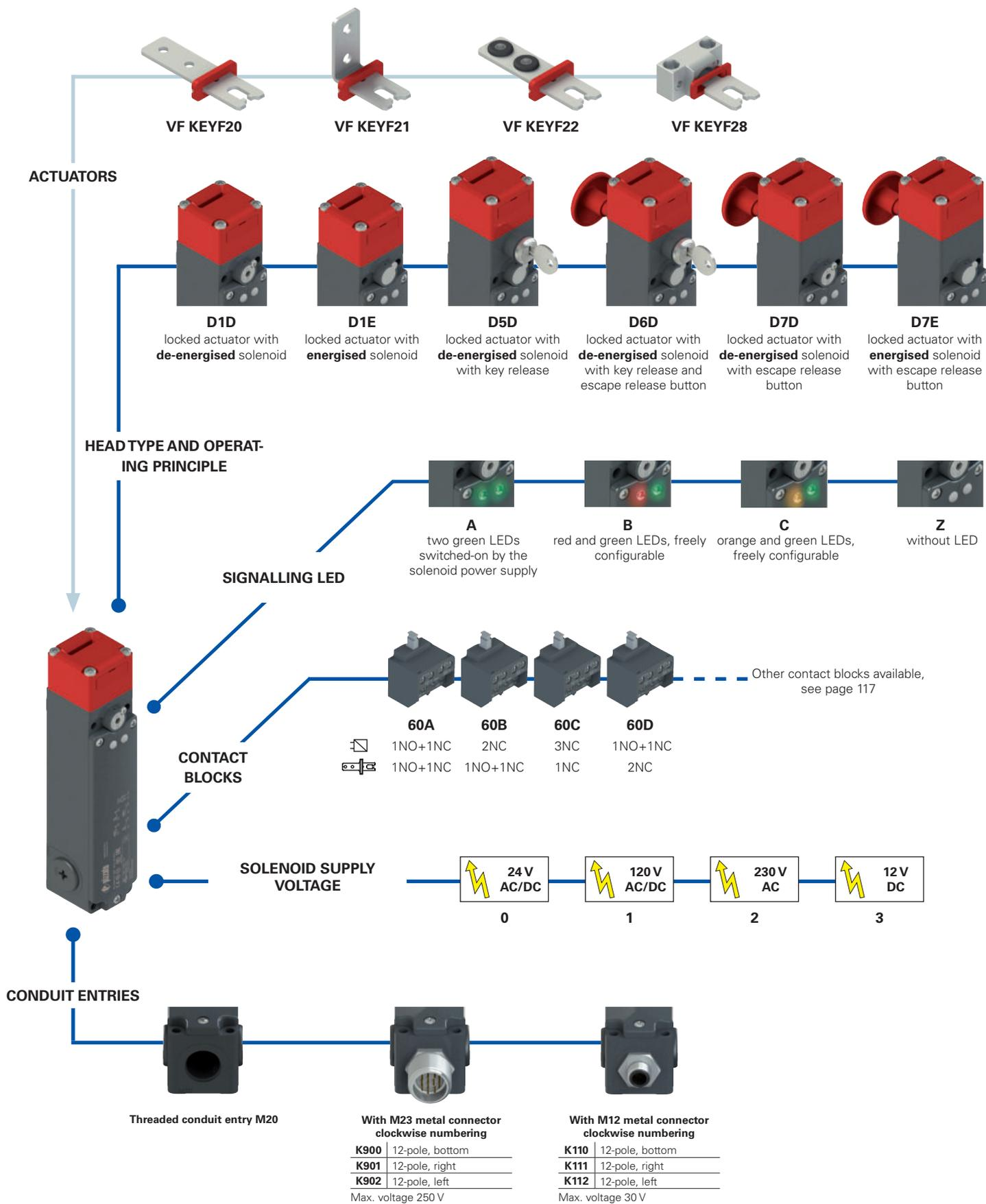

● product option  
 → sold separately as accessory



## Code structure

**Attention!** The feasibility of a code number does not mean the effective availability of a product. Please contact our sales office.

article options

# FG 60AD1D0A-LP30F20GK900T6V34

## Contact blocks

	Contacts activated by the solenoid 	Contacts activated by the actuator 
<b>60A</b>	1NO+1NC	1NO+1NC
<b>60B</b>	2NC	1NO+1NC
<b>60C</b>	3NC	1NC
<b>60D</b>	1NO+1NC	2NC
<b>60E</b>	1NO+2NC	1NC
<b>60F</b>	1NO+2NC	1NO
<b>60G</b>	2NC	2NC
<b>60H</b>	4NC	/
<b>60I</b>	3NC	1NO
<b>60L</b>	2NO+1NC	1NC
<b>60M</b>	2NO+1NC	1NO
<b>60N</b>	1NO+1NC	2NO
<b>60P</b>	1NC	3NC
<b>60R</b>	2NO+2NC	/
<b>60S</b>	1NC	2NO+1NC
<b>60T</b>	1NC	1NO+2NC
<b>60U</b>	/	4NC
<b>60V</b>	2NC	2NO
<b>60X</b>	1NO	3NC
<b>60Y</b>	1NO	1NO+2NC
<b>61A</b>	/	1NO+3NC
<b>61B</b>	/	2NO+2NC
<b>61C</b>	/	3NO+1NC
<b>61D</b>	1NC	3NO
<b>61E</b>	1NO	2NO+1NC
<b>61G</b>	2NO	1NO+1NC
<b>61H</b>	2NO	2NC
<b>61M</b>	3NO	1NC
<b>61R</b>	1NO+3NC	/
<b>61S</b>	3NO+1NC	/

Note: contact blocks 60U, 61A, 61B, 61C cannot be combined with operating principles D6D, D7D, D7E

## Operating principle

<b>D1D</b>	locked actuator with de-energised solenoid
<b>D1E</b>	locked actuator with energised solenoid
<b>D5D</b>	locked actuator with de-energised solenoid. With key release
<b>D6D</b>	locked actuator with de-energised solenoid. With key release and escape release button
<b>D7D</b>	locked actuator with de-energised solenoid. With escape release button
<b>D7E</b>	locked actuator with energised solenoid. With escape release button

## Removing the release key

The key can be removed in locked and unlocked actuator position (standard)

**V34** The key can be removed only in the locked position of the actuator

## Ambient temperature

-25°C ... +60°C (standard)

**T6** -40°C ... +60°C

## Pre-installed connectors

without connector (standard)

**K900** M23 metal connector, 12-pole, bottom

... ..

**K110** M12 metal connector, 12-pole, bottom

... ..

For the complete list of possible combinations please contact our technical department.

## Contact type

silver contacts (standard)

**G** silver contacts with 1 µm gold coating

## Actuators

without actuator (standard)

**F20** straight actuator VF KEYF20

**F21** angled actuator VF KEYF21

**F22** actuator with rubber pads VF KEYF22

**F28** universal actuator VF KEYF28

## Release button length

for max. 15 mm wall thickness (standard)

**LP30** for max. 30 mm wall thickness

**LP40** for max. 40 mm wall thickness

**LP60** for max. 60 mm wall thickness

**LPRG** adjustable, for wall thickness from 60 mm to 500 mm

## Signalling LED

**A** two green LEDs switched-on by the solenoid power supply

**B** red and green LEDs, freely configurable

**C** orange and green LEDs, freely configurable

**Z** without LED

## Solenoid supply voltage

**0** 24 Vac/dc (-10% ... +10%)

**1** 120 Vac/dc (-15% ... +10%)

**2** 230 Vac (-15% ... +10%)

**3** 12 Vdc (-15% ... +20%)



### Main features

- Actuator holding force  $F_{1max}$ : 2800 N
- 30 contact blocks with 4 contacts
- Metal housing, three M20 conduit entries
- Protection degree IP67
- Versions with key release and escape release button
- 4 stainless steel actuators
- Head and release devices, individually turnable and non-detachable
- Signalling LED
- Operation with energised or de-energised solenoid

### Quality marks:



IMQ approval:	CA02.03808
UL approval:	E131787
CCC approval:	2013010305602309
EAC approval:	RU C-IT.YT03.B.00035/19

### Technical data

#### Housing

Metal head and housing, baked powder coating.	
Three threaded conduit entries:	M20x1.5 (standard)
Protection degree:	IP67 acc. to EN 60529 with cable gland of equal or higher protection degree

#### General data

SIL (SIL CL) up to:	SIL 3 acc. to EN 62061
Performance Level (PL) up to:	PL e acc. to EN ISO 13849-1
Interlock with mechanical lock, coded:	type 2 acc. to EN ISO 14119
Coding level:	low acc. to EN ISO 14119
Safety parameters:	
$B_{10D}$ :	5,000,000 for NC contacts
Mission time:	20 years
Ambient temperature:	-25°C ... +60°C (standard) -40°C ... +60°C (T6 option)
Max. actuation frequency:	600 operating cycles/hour
Mechanical endurance:	1 million operating cycles
Max. actuation speed:	0.5 m/s
Min. actuation speed:	1 mm/s
Maximum force before breakage $F_{1max}$ :	2800 N acc. to EN ISO 14119
Max. holding force $F_{Zh}$ :	2150 N acc. to EN ISO 14119
Maximum clearance of locked actuator:	4.5 mm
Released actuator extraction force:	30 N
Tightening torques for installation:	see page 339
Wire cross-sections and wire stripping lengths:	see page 357

#### Solenoid

Duty cycle:	100% ED (continuous operation)
Solenoid protection 12 V:	type gG fuse 1 A
Solenoid protection 24 V:	type gG fuse 0.5 A
Solenoid protection 120 V:	fuse 315 mA, delayed
Solenoid protection 230 V:	fuse 315 mA, delayed
Solenoid consumption:	9 VA

#### In compliance with standards:

IEC 60947-5-1, IEC 60947-1, IEC 60204-1, EN ISO 14119, EN ISO 12100, IEC 60529, IEC 61000-6-2, IEC 61000-6-3, EN 50581, BG-GS-ET-15, UL 508, CSA 22.2 N. 14.

#### Approvals:

EN 60947-5-1, UL 508, CSA 22.2 N. 14, GB/T14048.5-2017.

#### Compliance with the requirements of:

Machinery Directive 2006/42/EC, EMC Directive 2014/30/EU, RoHS Directive 2011/65/EU.

#### Positive contact opening in conformity with standards:

IEC 60947-5-1, EN 60947-5-1.

**⚠ If not expressly indicated in this chapter, for correct installation and utilization of all articles see the instructions given on pages 337 to 350.**

### Electrical data

### Utilization category

	Thermal current ( $I_{th}$ ):	Rated insulation voltage (U):	Rated impulse withstand voltage ( $U_{imp}$ ):	Conditional short circuit current:	Protection against short circuits:	Pollution degree:	Utilization category
without connector	10 A	400 Vac 300 Vdc	6 kV	1000 A acc. to EN 60947-5-1	type gG fuse 10 A 500 V	3	Alternating current: AC15 (50÷60 Hz) $U_e$ (V) 120 250 400 $I_e$ (A) 6 5 3 Direct current: DC13 $U_e$ (V) 24 125 250 $I_e$ (A) 3 0.7 0.4
with M23 connector, 12-pole	8 A	250 Vac 300 Vdc			type gG fuse 8 A 500 V	3	Alternating current: AC15 (50÷60 Hz) $U_e$ (V) 120 250 $I_e$ (A) 6 5 Direct current: DC13 $U_e$ (V) 24 125 250 $I_e$ (A) 3 0.7 0.4
with M12 connector, 12-pole	1.5 A	30 Vac 36 Vdc			type gG fuse 1.5 A	3	Alternating current: AC15 (50÷60 Hz) $U_e$ (V) 24 $I_e$ (A) 1.5 Direct current: DC13 $U_e$ (V) 24 $I_e$ (A) 1.5





### Features approved by IMQ

Rated insulation voltage (U<sub>i</sub>): 400 Vac  
 Conventional free air thermal current (I<sub>th</sub>): 10 A  
 Protection against short circuits: type gG fuse 10 A 500 V  
 Rated impulse withstand voltage (U<sub>imp</sub>): 6 kV  
 Protection degree of the housing: IP67  
 MV terminals (screw terminals)  
 Pollution degree: 3  
 Utilization category: AC15  
 Operating voltage (U<sub>e</sub>): 400 Vac (50 Hz)  
 Operating current (I<sub>e</sub>): 3 A

Forms of the contact element: X+X+X+X, Y+Y+Y+Y, X+Y+Y+Y, X+X+Y+Y, X+X+X+Y  
 Positive opening of contacts on all contact blocks: 60A, 60B, 60C, 60D, 60E, 60F, 60G, 60H, 60I, 60L, 60M, 60N, 60P, 60R, 60S, 60T, 60U, 60V, 60X, 60Y, 61A, 61B, 61C, 61D, 61E, 61G, 61H, 61M, 61R, 61S

In compliance with standards: EN 60947-1, EN 60947-5-1, fundamental requirements of the Low Voltage Directive 2014/35/EU.

Please contact our technical department for the list of approved products.

### Features approved by UL

Electrical Ratings: A300 pilot duty (720 VA, 120-300 Vac)  
 Q300 pilot duty (69 VA, 125-250 Vdc)  
 Environmental Ratings: Types 1, 4X, 12, 13

Please contact our technical department for the list of approved products.

### Operating principle

The operating principle of these safety switches allows three different operating states:

- state A**: with inserted and locked actuator
- state B**: with inserted but not locked actuator
- state C**: with extracted actuator

All or some of these states can be monitored by means of electrical NO contacts or NC contacts with positive opening by selecting the appropriate contact blocks. In detail, contact blocks that have electric contacts marked with the symbol of the solenoid (⚡) are switched in the transition between the state A and state B, while the electric contacts marked with the symbol of the actuator (⚙️) are switched between state B and state C.

#### Operating principle

Select from two operating principles for actuator locking:

- Operating principle D**: locked actuator with de-energised solenoid. The actuator is released by applying the power supply to the solenoid (see example of the operating phases).
- Operating principle E**: locked actuator with energised solenoid. The actuator is released by switching off the power supply to the solenoid. This version should only be used under certain conditions, since a power failure at the system will result in the immediate opening of the guard.

### Example: operating phases with FG 60AD1D0A-F21 (switch with operating principle D)

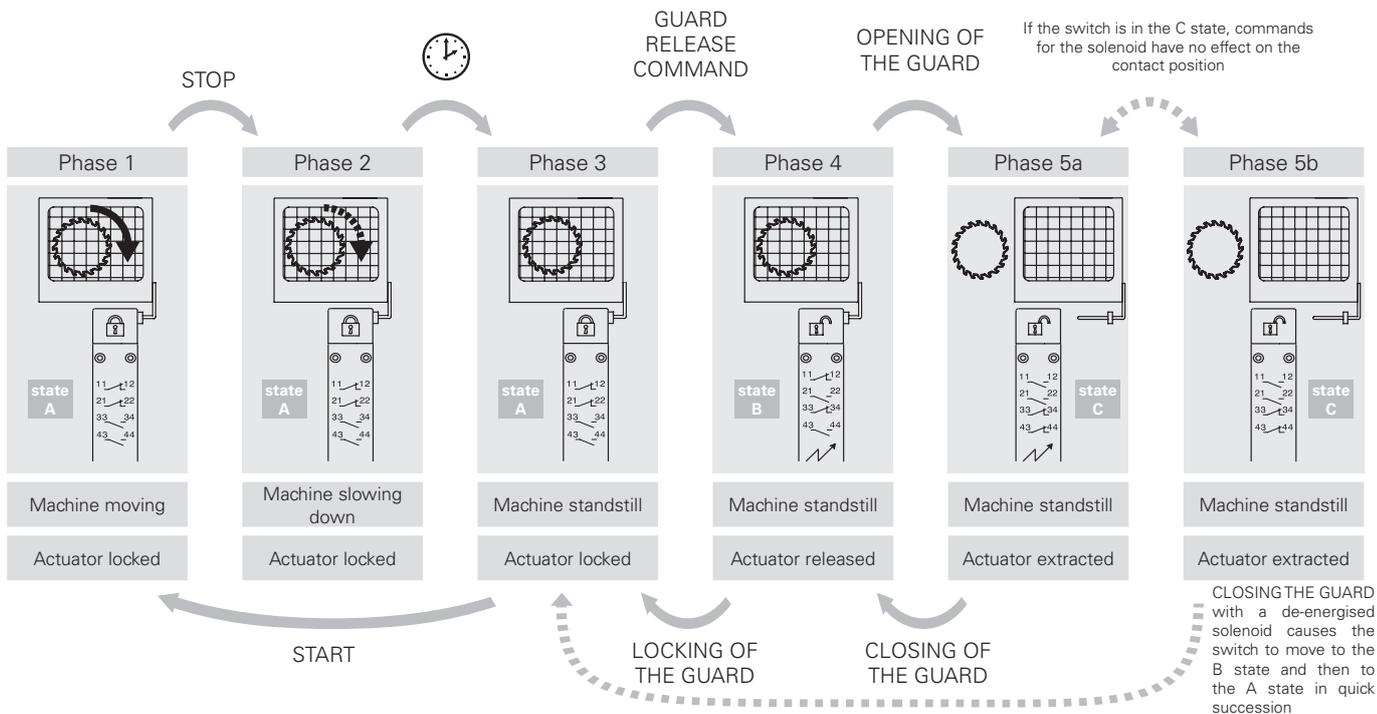





Operating state Actuator Solenoid	Operating principle D locked actuator with de-energised solenoid			Operating principle E locked actuator with energised solenoid		
	state A	state B	state C	state A	state B	state C
	Inserted and locked De-energised	Inserted and released Energised	Extracted -	Inserted and locked Energised	Inserted and released De-energised	Extracted -
FG 60T••••• 1NC controlled by the solenoid 1NO+2NC controlled by the actuator	11  12 21  22 31  32 43  44	11  12 21  22 31  32 43  44	11  12 21  22 31  32 43  44	11  12 21  22 31  32 43  44	11  12 21  22 31  32 43  44	11  12 21  22 31  32 43  44
FG 60U••••• 4NC controlled by the actuator	11  12 21  22 31  32 41  42	11  12 21  22 31  32 41  42	11  12 21  22 31  32 41  42	11  12 21  22 31  32 41  42	11  12 21  22 31  32 41  42	11  12 21  22 31  32 41  42
FG 60V••••• 2NC controlled by the solenoid 2NO controlled by the actuator	11  12 21  22 33  34 43  44	11  12 21  22 33  34 43  44	11  12 21  22 33  34 43  44	11  12 21  22 33  34 43  44	11  12 21  22 33  34 43  44	11  12 21  22 33  34 43  44
FG 60X••••• 1NO controlled by the solenoid 3NC controlled by the actuator	13  14 21  22 31  32 41  42	13  14 21  22 31  32 41  42	13  14 21  22 31  32 41  42	13  14 21  22 31  32 41  42	13  14 21  22 31  32 41  42	13  14 21  22 31  32 41  42
FG 60Y••••• 1NO controlled by the solenoid 1NO+2NC controlled by the actuator	11  12 21  22 33  34 43  44	11  12 21  22 33  34 43  44	11  12 21  22 33  34 43  44	11  12 21  22 33  34 43  44	11  12 21  22 33  34 43  44	11  12 21  22 33  34 43  44
FG 61A••••• 1NO+3NC controlled by the actuator	11  12 21  22 31  32 43  44	11  12 21  22 31  32 43  44	11  12 21  22 31  32 43  44	11  12 21  22 31  32 43  44	11  12 21  22 31  32 43  44	11  12 21  22 31  32 43  44
FG 61B••••• 2NO+2NC controlled by the actuator	11  12 21  22 33  34 43  44	11  12 21  22 33  34 43  44	11  12 21  22 33  34 43  44	11  12 21  22 33  34 43  44	11  12 21  22 33  34 43  44	11  12 21  22 33  34 43  44
FG 61C••••• 3NO+1NC controlled by the actuator	13  14 21  22 33  34 43  44	13  14 21  22 33  34 43  44	13  14 21  22 33  34 43  44	13  14 21  22 33  34 43  44	13  14 21  22 33  34 43  44	13  14 21  22 33  34 43  44
FG 61D••••• 1NC controlled by the solenoid 3NO controlled by the actuator	13  14 21  22 33  34 43  44	13  14 21  22 33  34 43  44	13  14 21  22 33  34 43  44	13  14 21  22 33  34 43  44	13  14 21  22 33  34 43  44	13  14 21  22 33  34 43  44
FG 61E••••• 1NO controlled by the solenoid 2NO+1NC controlled by the actuator	13  14 21  22 33  34 43  44	13  14 21  22 33  34 43  44	13  14 21  22 33  34 43  44	13  14 21  22 33  34 43  44	13  14 21  22 33  34 43  44	13  14 21  22 33  34 43  44
FG 61G••••• 2NO controlled by the solenoid 1NO+1NC controlled by the actuator	13  14 21  22 33  34 43  44	13  14 21  22 33  34 43  44	13  14 21  22 33  34 43  44	13  14 21  22 33  34 43  44	13  14 21  22 33  34 43  44	13  14 21  22 33  34 43  44
FG 61H••••• 2NO controlled by the solenoid 2NC controlled by the actuator	11  12 21  22 33  34 43  44	11  12 21  22 33  34 43  44	11  12 21  22 33  34 43  44	11  12 21  22 33  34 43  44	11  12 21  22 33  34 43  44	11  12 21  22 33  34 43  44
FG 61M••••• 3NO controlled by the solenoid 1NC controlled by the actuator	13  14 21  22 33  34 43  44	13  14 21  22 33  34 43  44	13  14 21  22 33  34 43  44	13  14 21  22 33  34 43  44	13  14 21  22 33  34 43  44	13  14 21  22 33  34 43  44
FG 61R••••• 1NO+3NC controlled by the solenoid	11  12 21  22 31  32 43  44	11  12 21  22 31  32 43  44	11  12 21  22 31  32 43  44	11  12 21  22 31  32 43  44	11  12 21  22 31  32 43  44	11  12 21  22 31  32 43  44
FG 61S••••• 3NO+1NC controlled by the solenoid	13  14 21  22 33  34 43  44	13  14 21  22 33  34 43  44	13  14 21  22 33  34 43  44	13  14 21  22 33  34 43  44	13  14 21  22 33  34 43  44	13  14 21  22 33  34 43  44

Contact type  
 = slow action

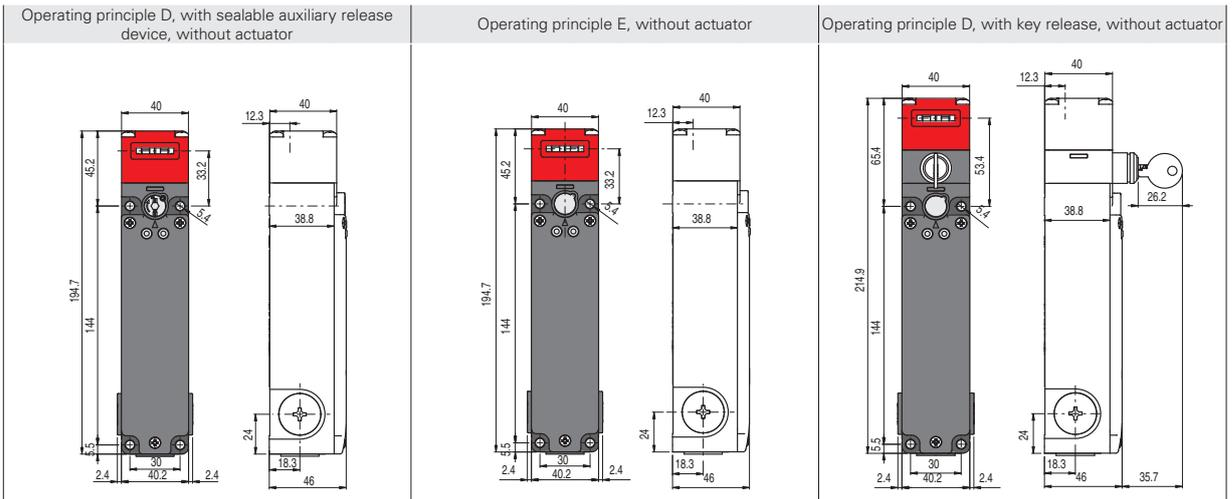

Contact blocks

	Operating principle D, with sealable auxiliary release device, without actuator	Operating principle E, without actuator	Operating principle D, with key release, without actuator
60A	FG 60AD1D0A   1NO+1NC 1NO+1NC	FG 60AD1E0A  1NO+1NC 1NO+1NC	FG 60AD5D0A  1NO+1NC 1NO+1NC
60B	FG 60BD1D0A   2NC 1NO+1NC	FG 60BD1E0A  2NC 1NO+1NC	FG 60BD5D0A  2NC 1NO+1NC
60C	FG 60CD1D0A   3NC 1NC	FG 60CD1E0A  3NC 1NC	FG 60CD5D0A  3NC 1NC
60D	FG 60DD1D0A   1NO+1NC 2NC	FG 60DD1E0A  1NO+1NC 2NC	FG 60DD5D0A  1NO+1NC 2NC
60E	FG 60ED1D0A   1NO+2NC 1NC	FG 60ED1E0A  1NO+2NC 1NC	FG 60ED5D0A  1NO+2NC 1NC
60F	FG 60FD1D0A   1NO+2NC 1NO	FG 60FD1E0A  1NO+2NC 1NO	FG 60FD5D0A  1NO+2NC 1NO
60G	FG 60GD1D0A   2NC 2NC	FG 60GD1E0A  2NC 2NC	FG 60GD5D0A  2NC 2NC
60H	FG 60HD1D0A   4NC /	FG 60HD1E0A  4NC /	FG 60HD5D0A  4NC /
60I	FG 60ID1D0A   3NC 1NO	FG 60ID1E0A  3NC 1NO	FG 60ID5D0A  3NC 1NO
60L	FG 60LD1D0A   2NO+1NC 1NC	FG 60LD1E0A  2NO+1NC 1NC	FG 60LD5D0A  2NO+1NC 1NC
60M	FG 60MD1D0A   2NO+1NC 1NO	FG 60MD1E0A  2NO+1NC 1NO	FG 60MD5D0A  2NO+1NC 1NO
60N	FG 60ND1D0A   1NO+1NC 2NO	FG 60ND1E0A  1NO+1NC 2NO	FG 60ND5D0A  1NO+1NC 2NO
60P	FG 60PD1D0A   1NC 3NC	FG 60PD1E0A  1NC 3NC	FG 60PD5D0A  1NC 3NC
60R	FG 60RD1D0A   2NO+2NC /	FG 60RD1E0A  2NO+2NC /	FG 60RD5D0A  2NO+2NC /
60S	FG 60SD1D0A   1NC 2NO+1NC	FG 60SD1E0A  1NC 2NO+1NC	FG 60SD5D0A  1NC 2NO+1NC
60T	FG 60TD1D0A   1NC 1NO+2NC	FG 60TD1E0A  1NC 1NO+2NC	FG 60TD5D0A  1NC 1NO+2NC
60U	FG 60UD1D0A   / 4NC	FG 60UD1E0A  / 4NC	FG 60UD5D0A  / 4NC
60V	FG 60VD1D0A   2NC 2NO	FG 60VD1E0A  2NC 2NO	FG 60VD5D0A  2NC 2NO
60X	FG 60XD1D0A   1NO 3NC	FG 60XD1E0A  1NO 3NC	FG 60XD5D0A  1NO 3NC
60Y	FG 60YD1D0A   1NO 1NO+2NC	FG 60YD1E0A  1NO 1NO+2NC	FG 60YD5D0A  1NO 1NO+2NC
61A	FG 61AD1D0A   / 1NO+3NC	FG 61AD1E0A  / 1NO+3NC	FG 61AD5D0A  / 1NO+3NC
61B	FG 61BD1D0A   / 2NO+2NC	FG 61BD1E0A  / 2NO+2NC	FG 61BD5D0A  / 2NO+2NC
61C	FG 61CD1D0A   / 3NO+1NC	FG 61CD1E0A  / 3NO+1NC	FG 61CD5D0A  / 3NO+1NC
61D	FG 61DD1D0A   1NC 3NO	FG 61DD1E0A  1NC 3NO	FG 61DD5D0A  1NC 3NO
61E	FG 61ED1D0A   1NO 2NO+1NC	FG 61ED1E0A  1NO 2NO+1NC	FG 61ED5D0A  1NO 2NO+1NC
61G	FG 61GD1D0A   2NO 1NO+1NC	FG 61GD1E0A  2NO 1NO+1NC	FG 61GD5D0A  2NO 1NO+1NC
61H	FG 61HD1D0A   2NO 2NC	FG 61HD1E0A  2NO 2NC	FG 61HD5D0A  2NO 2NC
61M	FG 61MD1D0A   3NO 1NC	FG 61MD1E0A  3NO 1NC	FG 61MD5D0A  3NO 1NC
61R	FG 61RD1D0A   1NO+3NC /	FG 61RD1E0A  1NO+3NC /	FG 61RD5D0A  1NO+3NC /
61S	FG 61SD1D0A   3NO+1NC /	FG 61SD1E0A  3NO+1NC /	FG 61SD5D0A  3NO+1NC /
Actuating force	30 N (60 N )	30 N (60 N )	30 N (60 N )
Travel diagrams	Page 117	Page 117	Page 117

Legend: With positive opening according to EN 60947-5-1, interlock with lock monitoring acc. to EN ISO 14119



Travel diagrams

<p><b>60A</b> 2NO+2NC</p>	<p><b>60M</b> 3NO+1NC</p>	<p><b>61A</b> 1NO+3NC</p>
<p><b>60B</b> 1NO+3NC</p>	<p><b>60N</b> 3NO+1NC</p>	<p><b>61B</b> 2NO+2NC</p>
<p><b>60C</b> 4NC</p>	<p><b>60P</b> 4NC</p>	<p><b>61C</b> 3NO+1NC</p>
<p><b>60D</b> 1NO+3NC</p>	<p><b>60R</b> 2NO+2NC</p>	<p><b>61D</b> 3NO+1NC</p>
<p><b>60E</b> 1NO+3NC</p>	<p><b>60S</b> 2NO+2NC</p>	<p><b>61E</b> 3NO+1NC</p>
<p><b>60F</b> 2NO+2NC</p>	<p><b>60T</b> 1NO+3NC</p>	<p><b>61G</b> 3NO+1NC</p>
<p><b>60G</b> 4NC</p>	<p><b>60U</b> 4NC</p>	<p><b>61H</b> 2NO+2NC</p>
<p><b>60H</b> 4NC</p>	<p><b>60V</b> 2NO+2NC</p>	<p><b>61M</b> 3NO+1NC</p>
<p><b>60I</b> 1NO+3NC</p>	<p><b>60X</b> 1NO+3NC</p>	<p><b>61R</b> 1NO+3NC</p>
<p><b>60L</b> 2NO+2NC</p>	<p><b>60Y</b> 2NO+2NC</p>	<p><b>61S</b> 3NO+1NC</p>

**Legend:**  
 Closed contact  
 Open contact  
 Contacts activated by the actuator  
 Contacts activated by the solenoid  
 Positive opening travel

Stainless steel actuators

**IMPORTANT:** These actuators can be used only with items of the FG series (e.g. FG 60AD1D0A).  
 Low level of coding acc. to EN ISO 14119.

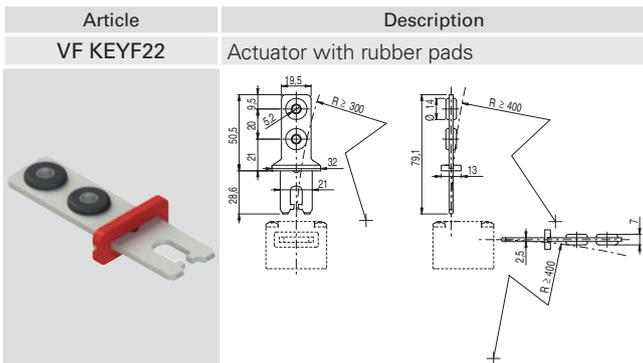
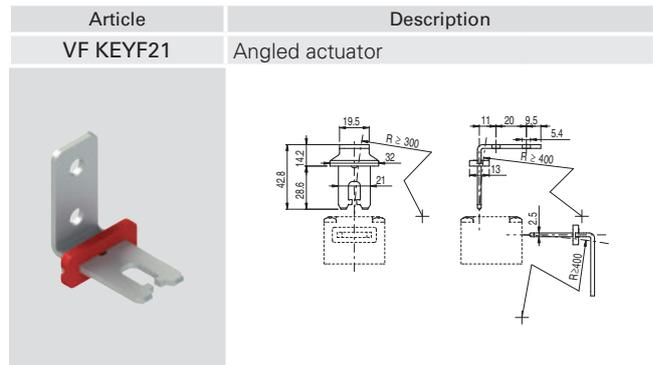
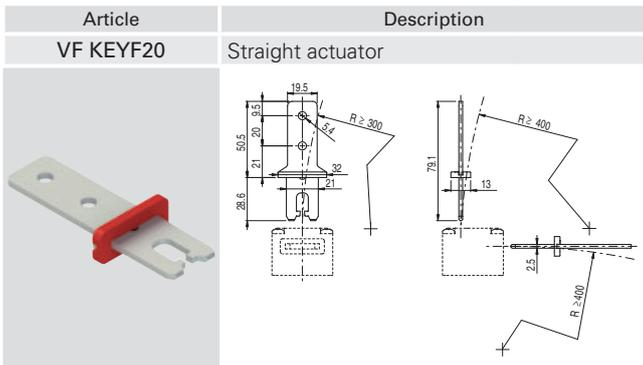

All values in the drawings are in mm

Accessories See page 321

→ The 2D and 3D files are available at [www.pizzato.com](http://www.pizzato.com)



## Other release button lengths

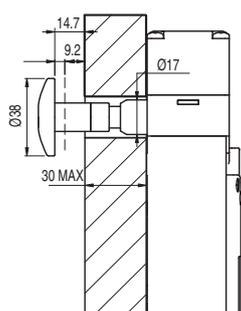

-LP30

For wall thickness  
15 ... 30 mm

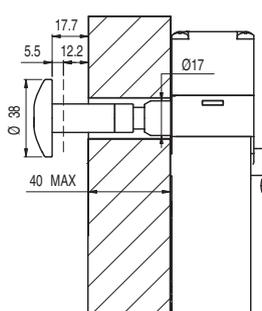

-LP40

For wall thickness  
30 ... 40 mm

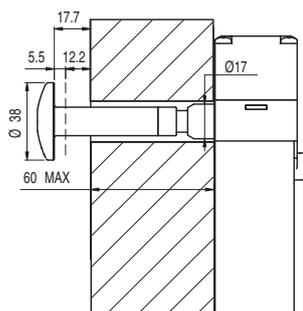

-LP60

For wall thickness  
40 ... 60 mm

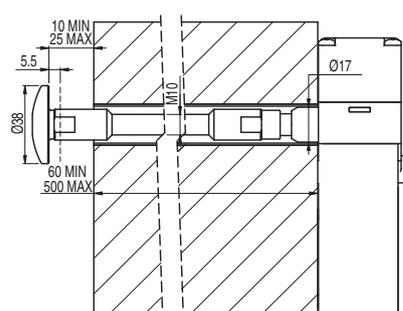

-LPRG

For wall thickness  
60 ... 500 mm

- Avoid bending and twisting the release button.
- To guarantee correct device operation, keep a distance of 10 ... 25 mm between the wall and the release button.
- The actuation path of the release button must always be kept clean. Dirt or chemical products could compromise the device operation.
- Periodically check the device for proper function.

- Avoid bending and twisting the release button.
- On the inside of the wall, use a bushing or a tube with an inner diameter of  $18 \pm 0.5$  mm as a guide.
- Guide in the M10 threaded rod in such a way so as to prevent bending. The M10 threaded rod is not supplied with the device.
- Use medium-strength thread locker to secure the threaded rod.
- Do not exceed an overall length of 500 mm between the release button and the switch.
- To guarantee correct device operation, keep a distance of 10 ... 25 mm between the wall and the release button.
- The actuation path of the release button must always be kept clean. Dirt or chemical products could compromise the device operation.
- Periodically check the device for proper function.

## Release button



Article	Description
VF FG-LP15	Technopolymer release button for max. 15 mm wall thickness, supplied with screw
VF FG-LP30	Technopolymer release button for max. 30 mm wall thickness, supplied with screw
VF FG-LP40	Technopolymer release button for max. 40 mm wall thickness, supplied with screw
VF FG-LP60	Metal release button for max. 60 mm wall thickness, supplied with screw



Article	Description
VF FG-LPRG	Metal release button for wall thickness from 60 to 500 mm, supplied with 2 supports and 2 screws, without M10 threaded bar

The M10 bar can be supplied in zinc-plated steel with 1 m length. Article: AC 8512.



## Safety modules

Pizzato Elettrica offers its customers a wide range of safety modules. These were developed taking into consideration typical problems encountered during the monitoring of safety switches under actual operating conditions. Safety modules with instantaneous or delayed contacts for emergency circuits of type 0 (immediate stop) or type 1 (controlled stop).

Safety switches with solenoid of the FG series can be connected to safety modules for the realization of safety circuits up to PL e acc. to EN ISO 13849. For technical information or wiring diagrams, please contact our technical office.

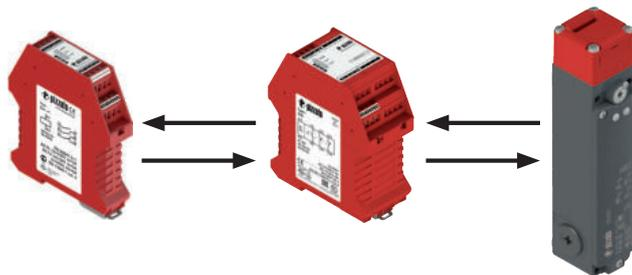

## Application example with safety timer

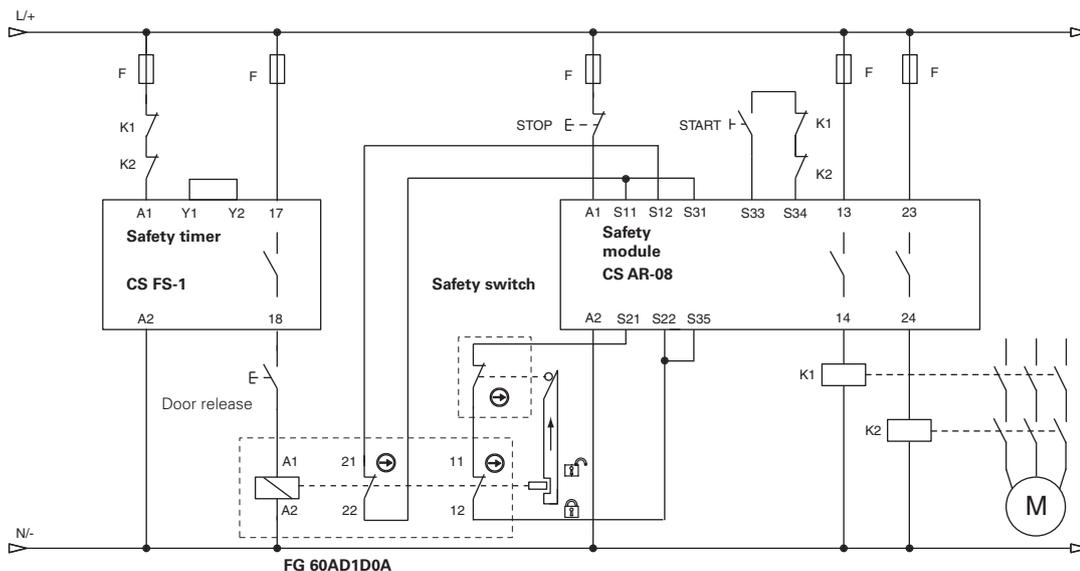

## Application example with safety module for standstill monitoring

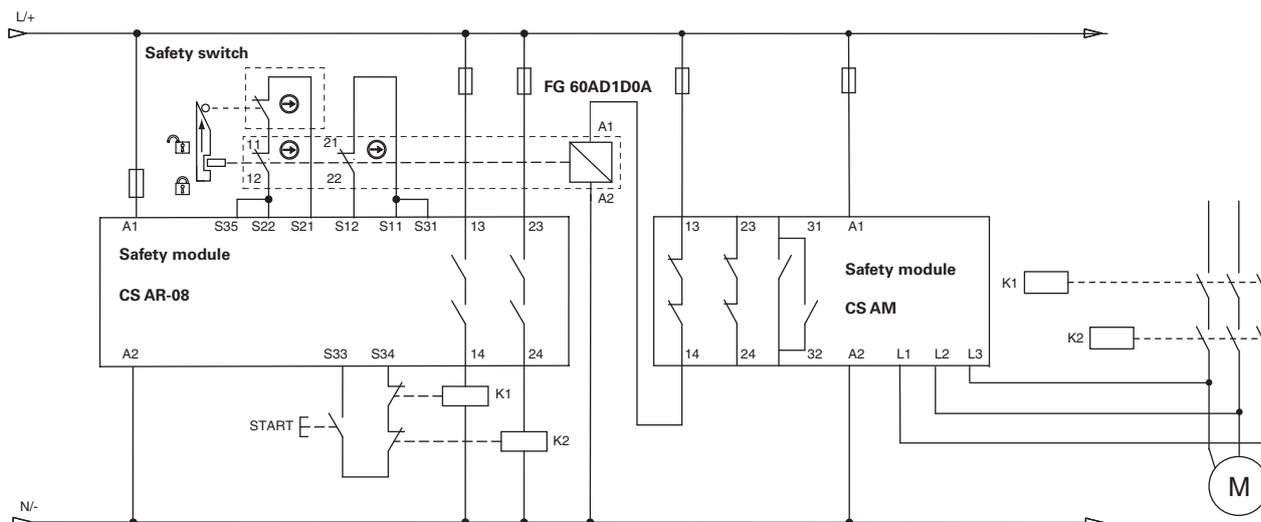

NOTE: The NC contacts of K1 and K2 are mechanically guided (EN 60947-4-1, Annex F)

## Description



These switches are used on machines where the hazardous conditions remain for a while, even after the machines have been switched off, for example because of mechanical inertia of pulleys, saw disks, parts under pressure or with high temperatures. Thus, the switches can also be used if individual guards are only to be opened under certain conditions.

The versions with solenoid actuated NC contacts are considered interlocks with locking in accordance with ISO 14119, and the product's label is marked with the symbol shown.

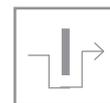

## Head and release devices with variable orientation

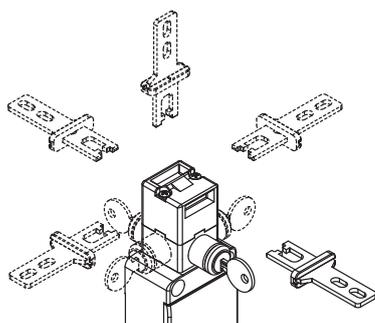

The head can be quickly turned to each of the four sides of the switch by unfastening the two fastening screws.

The auxiliary key release device can be rotated in 90° steps as well. This enables the switch to assume 32 different configurations.

## Wide-ranging actuator travel

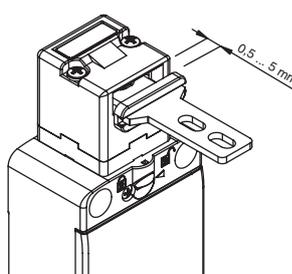

The actuation head of this switch features a wide range of travel. In this way the guard can oscillate along the direction of insertion (4.5 mm) without causing unwanted machine shutdowns. This wide range of travel is available in all actuators in order to ensure maximum device reliability.

## Holding force of the locked actuator

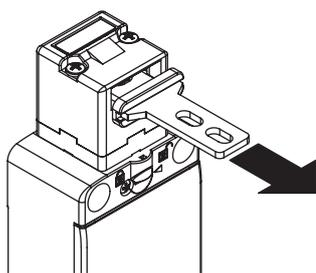

The robust interlocking system guarantees a maximum actuator holding force of  $F_{1max} = 1100 \text{ N}$ .

## Safety screws for actuators

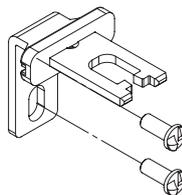

As required by EN ISO 14119, the actuator must be fixed immovably to the guard frame. Pan head safety screws with one-way fitting are available for this purpose. With this screw type, the actuators cannot be removed or tampered by using common tools. See accessories on page 332.

## Protection degree IP67

**IP67** These devices are designed to be used in the toughest environmental conditions and they pass the IP67 immersion test acc. to EN 60529. They can therefore be used in all environments where maximum protection degree of the housing is required.

## Contact block



Contact blocks with captive screws, finger protection, twin bridge contacts and double interruption for higher contact reliability. Versions with gold-plated contacts available. Available in multiple variants with actuation by actuator or by solenoid.

## Turnable key release with lock

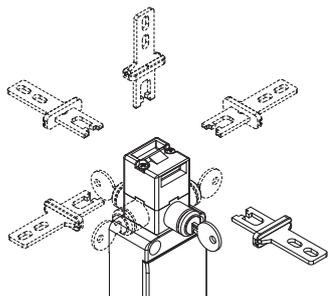

The auxiliary key release device is used to allow the maintenance or the entry into the machinery to authorized personnel only. Turning the key corresponds to actuating the solenoid: the actuator is released. The device can be turned, thereby enabling installation of the safety switch in the machine while the release device remains accessible on the outside of the guard.

## Circuit board for monitoring the current consumption of the solenoid.

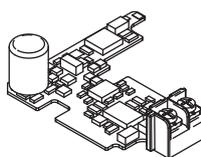

This technical solution resolves the problems that may derive from unstable power supply (machine distance from main transformers, voltage variation between night/day hours), allowing also a low solenoid power consumption and consequently enlarging the working temperature range of the switch.



### Laser engraving



All FS series switches are permanently marked with a special laser system. As a result, the marking remains legible even under extreme operating conditions. Thanks to this system that does not use labels, the loss of plate data is prevented and a greater resistance of the marking is achieved over time.

### Holding force of the unlocked actuator

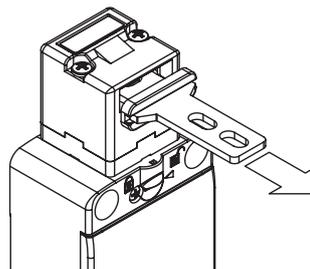

The inside of each switch features a device which holds the actuator in its closed position. Ideal for all those applications where several guards are unlocked simultaneously, but only one is actually opened. The device keeps all the unlocked guards in their position with a retaining force of approx. 30 N, stopping any vibrations or gusts of wind from opening them.

### Two operating principles

# D or E

The safety switches with solenoid offer two different operating principles for the actuator locking:

Operating principle D: locked actuator with de-energised solenoid. The actuator is released by applying the power supply to the solenoid.

Operating principle E: locked actuator with energised solenoid. The actuator is released by switching off the power supply to the solenoid. This version should only be used under certain conditions, since a power failure at the system will result in the immediate opening of the guard.

### Sealable auxiliary release device



Switches with locked actuator with deactivated solenoid (function principle D) are equipped with an auxiliary release device for the solenoid to simplify installation of the switch and to facilitate entry into the danger zone in the event of a power failure. The auxiliary

release device acts on the switch exactly as if the solenoid was energised. As a result, it also actuates the electrical contacts. Can only be actuated with a couple of tools, this ensures adequate resistance to tampering. If required it can be sealed by means of the hole provided.

### Cable outputs

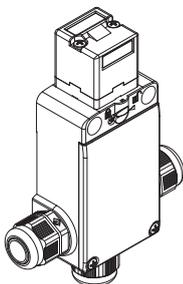

The switch is provided with three cable entries in different directions. This allows its application in series connections or in narrow places.

### Gold-plated contacts

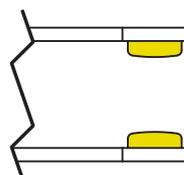

The contact blocks of these devices can be supplied gold-plated upon request. Ideal for applications with low voltages or currents; it ensures increased contact reliability. Available in two thicknesses (1 or 2.5 microns), it adapts perfectly to the various fields of application, ensuring a long endurance over time.

### LED signalling lights



Thanks to the three threaded cable entries, the high luminosity LED signalling lights of the VF SL series can be installed on the switch.

The LED signalling lights can be easily installed by screwing them on one of the conduit entries not used for electric cables. They can be used for many different purposes: for example, to signal, from a distance, whether the switch has been actuated; whether the guard has closed correctly; or whether the guard is locked or unlocked.

For more information see chapter Accessories, page 321.

Selection diagram

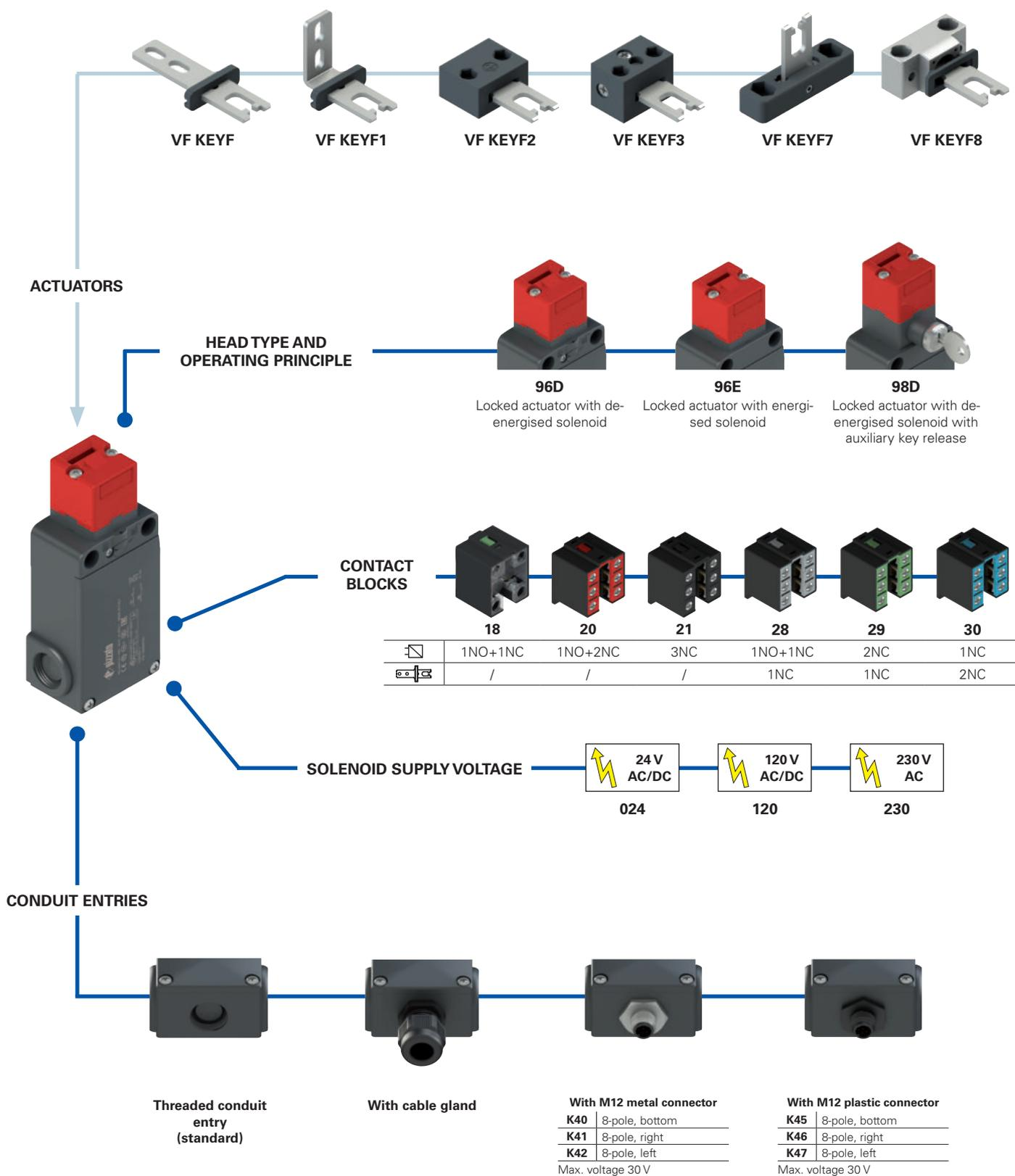

● product option  
 → sold separately as accessory



**Code structure** **Attention!** The feasibility of a code number does not mean the effective availability of a product. Please contact our sales office.

article options options  
**FS 1896D024-F1GM2K40V34**

Contact blocks		
	Contacts activated by the solenoid	Contacts activated by the actuator
<b>18</b>	1NO+1NC	/
<b>20</b>	1NO+2NC	/
<b>21</b>	3NC	/
<b>28</b>	1NO+1NC	1NC
<b>29</b>	2NC	1NC
<b>30</b>	1NC	2NC

Head type and operating principle	
<b>96D</b>	locked actuator with de-energised solenoid
<b>96E</b>	locked actuator with energised solenoid
<b>98D</b>	locked actuator with de-energised solenoid with auxiliary key release

Solenoid supply voltage	
<b>024</b>	24 Vac/dc (-10% ... +25%).
<b>120</b>	120 Vac/dc (-15% ... +20%)
<b>230</b>	230 Vac (-15% ... +10%)

Actuators	
	without actuator (standard)
<b>F</b>	straight actuator VF KEYF
<b>F1</b>	angled actuator VF KEYF1
<b>F2</b>	jointed actuator VF KEYF2
<b>F3</b>	jointed actuator adjustable in two directions VF KEYF3
<b>F7</b>	jointed actuator adjustable in one direction VF KEYF7
<b>F8</b>	universal actuator VF KEYF8

Removing the release key	
	The key can be removed in locked and unlocked actuator position (standard)
<b>V34</b>	The key can be removed only in the locked position of the actuator

Pre-installed cable glands or connectors	
	no cable gland or connector (standard)
<b>K23</b>	cable gland for cables Ø 6 ... 12 mm
...	.....
<b>K40</b>	M12 metal connector, 8-pole
...	.....
<b>K45</b>	M12 plastic connector, 8-pole
...	.....

For the complete list of possible combinations please contact our technical department.

Threaded conduit entry	
<b>M2</b>	M20x1.5 (standard)
	PG 13.5

Contact type	
	silver contacts (standard)
<b>G</b>	silver contacts with 1 µm gold coating
<b>G1</b>	silver contacts, 2.5 µm gold coating (not for contact blocks 20, 21, 28, 29, 30)



### Main features

- Technopolymer housing, three conduit entries
- Protection degree IP67
- 6 contact blocks available
- 6 stainless steel actuators available
- 3 solenoid supply voltages available
- Versions with auxiliary release device or turnable lock
- Operation with energised or de-energised solenoid

### Quality marks:



IMQ approval:	CA02.03808
UL approval:	E131787
CCC approval:	2007010305230011
EAC approval:	RU C-IT.YT03.B.00035/19

### Technical data

#### Housing

Housing made of glass fibre reinforced technopolymer, self-extinguishing, shock-proof and with double insulation:

Three knock-out threaded conduit entries:	M20x1.5 (standard)
Protection degree:	IP67 acc. to EN 60529 with cable gland of equal or higher protection degree

#### General data

SIL (SIL CL) up to:	SIL 3 acc. to EN 62061
Performance Level (PL) up to:	PL e acc. to EN ISO 13849-1
Interlock with mechanical lock, coded:	type 2 acc. to EN ISO 14119
Coding level:	low acc. to EN ISO 14119
Safety parameters:	
$B_{10D}$ :	4,000,000 for NC contacts
Mission time:	20 years
Ambient temperature:	-25°C ... +60°C
Max. actuation frequency:	600 operating cycles/hour
Mechanical endurance:	800,000 operating cycles
Max. actuation speed:	0.5 m/s
Min. actuation speed:	1 mm/s
Maximum force before breakage $F_{1max}$ :	1100 N (head 96), 900 N (head 98) acc. to EN ISO 14119
Max. holding force $F_{Zh}$ :	846 N (head 96), 692 N (head 98) acc. to EN ISO 14119
Maximum clearance of locked actuator:	4.5 mm
Released actuator extraction force:	30 N
Tightening torques for installation:	see page 339
Wire cross-sections and wire stripping lengths:	see page 357

#### Solenoid

Duty cycle:	100% ED (continuous operation)
Solenoid inrush power:	20 VA 0.1 s (24 V) 18 VA 0,1 s (120 V) 18 VA 0,1 s (230 V)
Solenoid consumption:	4 VA
Average overall consumption:	10 VA
Solenoid protection 24 V:	fuse 500 mA, delayed
Solenoid protection 120 V:	fuse 315 mA, delayed
Solenoid protection 230 V:	fuse 160 mA, delayed

**Notes:** Calculate the power supply using the average overall consumption. Please consider the solenoid inrush power in order to avoid intervention of overload-protection in case of electronic power supply.

#### In compliance with standards:

IEC 60947-5-1, IEC 60947-1, IEC 60204-1, EN ISO 14119, EN ISO 12100, IEC 60529, IEC 61000-6-2, IEC 61000-6-3, EN 50581, BG-GS-ET-15, UL 508, CSA 22.2 N. 14.

#### Approvals:

EN 60947-5-1, UL 508, CSA 22.2 N. 14, GB/T14048.5-2017.

#### Compliance with the requirements of:

Machinery Directive 2006/42/EC, EMC Directive 2014/30/EU, RoHS Directive 2011/65/EU.

#### Positive contact opening in conformity with standards:

IEC 60947-5-1, EN 60947-5-1.

**⚠ If not expressly indicated in this chapter, for correct installation and utilization of all articles see the instructions given on pages 337 to 350.**

### Electrical data

### Utilization category

without connector	Thermal current ( $I_{th}$ ):	10 A	Alternating current: AC15 (50-60 Hz)			
	Rated insulation voltage (U):	500 Vac 600 Vdc	$U_e$ (V)	250	400	500
	Rated impulse withstand voltage ( $U_{imp}$ ):	400 Vac 500 Vdc (contact blocks 20, 21, 28, 29, 30)	$I_e$ (A)	6	4	1
	Conditional short circuit current:	6 kV	Direct current: DC13			
with M12 connector, 8-pole	Protection against short circuits:	4 kV (contact blocks 20, 21, 28, 29, 30)	$U_e$ (V)	24	125	250
	Pollution degree:	1000 A acc. to EN 60947-5-1	$I_e$ (A)	3	0.55	0.3
		type aM fuse 10 A 500 V				
		3				

with M12 connector, 8-pole	Thermal current ( $I_{th}$ ):	2 A	Alternating current: AC15 (50-60 Hz)			
	Rated insulation voltage (U):	30 Vac 36 Vdc	$U_e$ (V)	24		
	Protection against short circuits:	type gG fuse 2 A 500 V	$I_e$ (A)	2		
	Pollution degree:	3	Direct current: DC13			
		$U_e$ (V)	24			
		$I_e$ (A)	2			



### Features approved by IMQ

Rated insulation voltage (U <sub>i</sub> ):	500 Vac 400 Vac (for contact blocks 20, 21, 28, 29, 30)
Conventional free air thermal current (I <sub>th</sub> ):	10 A
Protection against short circuits:	type aM fuse 10 A 500 V
Rated impulse withstand voltage (U <sub>imp</sub> ):	6 kV 4 kV (for contact blocks 20, 21, 28, 29, 30)
Protection degree of the housing: MV terminals (screw terminals)	IP67
Pollution degree:	3
Utilization category:	AC15
Operating voltage (U <sub>op</sub> ):	400 Vac (50 Hz)
Operating current (I <sub>o</sub> ):	3 A
Forms of the contact element:	Zb, Y+Y+X, Y+Y+Y, Y+X+X
Positive opening contacts on contact blocks	18, 20, 21, 28, 29, 30
In compliance with standards:	EN 60947-1, EN 60947-5-1, fundamental requirements of the Low Voltage Directive 2014/35/EU.

**Please contact our technical department for the list of approved products.**

### Features approved by UL

Electrical Ratings:	Q300 pilot duty (69 VA, 125-250 V dc) A600 pilot duty (720 VA, 120-600 V ac)
Environmental Ratings:	Types 1, 4X, 12, 13
Use 60 or 75 °C copper (Cu) conductor and wire size range 12, 14 AWG, stranded or solid. The terminal tightening torque of 7.1 lb in (0.8 Nm).	

**Please contact our technical department for the list of approved products.**

### Operating principle

The operating principle of these safety switches allows three different operating states:

**state A**: with inserted and locked actuator

**state B**: with inserted but not locked actuator

**state C**: with extracted actuator

All or some of these states can be monitored by means of electrical contacts with positive opening by selecting the appropriate contact blocks. In detail, contact blocks that have electric contacts marked with the symbol of the solenoid () are switched in the transition between the state A and state B, while the electric contacts marked with the symbol of the actuator () are switched between state B and state C.

It is also possible to choose between two operating principles for the actuator locking:

- **Operating principle D**: locked actuator with de-energised solenoid. The actuator is released by applying the power supply to the solenoid (see example of the operating phases).
- **Operating principle E**: locked actuator with energised solenoid. The actuator is released by switching off the power supply to the solenoid. This version should only be used under certain conditions, since a power failure at the system will result in the immediate opening of the guard.

### Example: operating phases with FS 2896D024-F1 (switch with operating principle D)

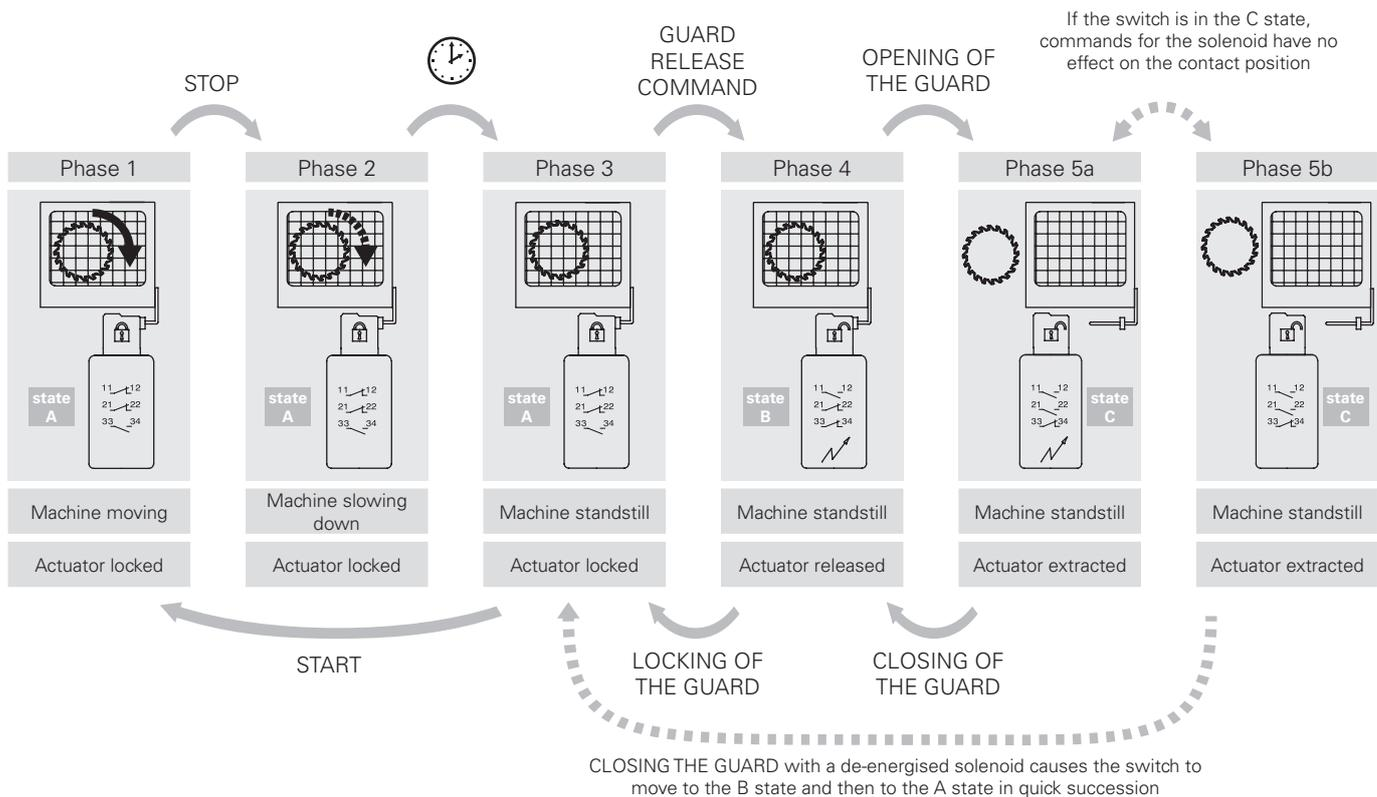

### Installation of two or more switches connected to the same power supply

#### 24 V AC/DC versions only

- This operation is intended to reduce the effects of the combined solenoid inrush currents on the power supply and should only be executed if necessary and with great care.
- Switch off the power supply.
- Open the switch cover.
- Loosen the two screws that secure the black plastic protective cover of the solenoid to the switch body and remove the plastic protective cover.
- Use a pin to set the selector switch so that each switch has a different combination (see figure at the side). If more than two switches are installed, repeat the combinations for any next set of two switches.
- Reposition the black plastic protective cover and tighten the two screws with a torque of 0.8 Nm.

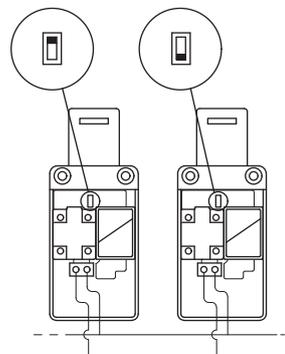





## Contact positions related to switch states

Operating state	Operating principle D locked actuator with de-energised solenoid			Operating principle E locked actuator with energised solenoid		
	state A	state B	state C	state A	state B	state C
Actuator	Inserted and locked	Inserted and released	Extracted	Inserted and locked	Inserted and released	Extracted
Solenoid	De-energised	Energised	-	Energised	De-energised	-

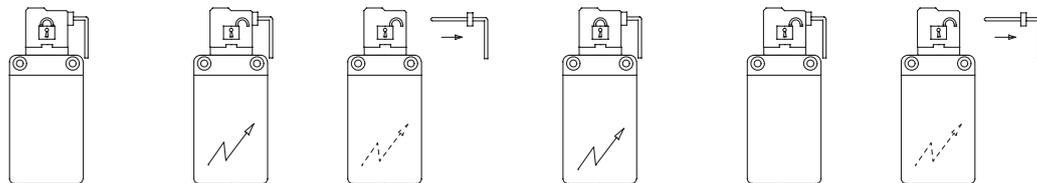

<b>FS 18</b> ..... 1NO+1NC controlled by the solenoid		11 — 12	11 — 12	11 — 12	11 — 12	11 — 12	11 — 12
		23 — 24	23 — 24	23 — 24	23 — 24	23 — 24	23 — 24
<b>FS 20</b> ..... 1NO+2NC controlled by the solenoid		11 — 12	11 — 12	11 — 12	11 — 12	11 — 12	11 — 12
		21 — 22	21 — 22	21 — 22	21 — 22	21 — 22	21 — 22
		33 — 34	33 — 34	33 — 34	33 — 34	33 — 34	33 — 34
<b>FS 21</b> ..... 3NC controlled by the solenoid		11 — 12	11 — 12	11 — 12	11 — 12	11 — 12	11 — 12
		21 — 22	21 — 22	21 — 22	21 — 22	21 — 22	21 — 22
		31 — 32	31 — 32	31 — 32	31 — 32	31 — 32	31 — 32
<b>FS 28</b> ..... 1NO+1NC controlled by the solenoid 1NC controlled by the actuator		11 — 12	11 — 12	11 — 12	11 — 12	11 — 12	11 — 12
		21 — 22	21 — 22	21 — 22	21 — 22	21 — 22	21 — 22
		33 — 34	33 — 34	33 — 34	33 — 34	33 — 34	33 — 34
<b>FS 29</b> ..... 2NC controlled by the solenoid 1NC controlled by the actuator		11 — 12	11 — 12	11 — 12	11 — 12	11 — 12	11 — 12
		21 — 22	21 — 22	21 — 22	21 — 22	21 — 22	21 — 22
		31 — 32	31 — 32	31 — 32	31 — 32	31 — 32	31 — 32
<b>FS 30</b> ..... 1NC controlled by the solenoid 2NC controlled by the actuator		11 — 12	11 — 12	11 — 12	11 — 12	11 — 12	11 — 12
		21 — 22	21 — 22	21 — 22	21 — 22	21 — 22	21 — 22
		31 — 32	31 — 32	31 — 32	31 — 32	31 — 32	31 — 32

## Limits of use

Do not use where dust and dirt may penetrate in any way into the head and deposit there. Especially not where powder, shavings, concrete or chemicals are sprayed. Adhere to the EN ISO 14119 requirements regarding low level of coding for interlocks. Do not use in environments with presence of explosive or flammable gas. In these case use ATEX products (see dedicated Pizzato catalogue).

Attention! These switches alone are not suitable for applications where operators may physically enter the dangerous area, because an eventual closing of the door behind them could restart the machine operation. In these cases the actuator entry locking device VF KB1 shown on page 129 must be used.

Contact type: [L] = slow action	Operating principle D, with sealable auxiliary release device, without actuator	Operating principle E, without actuator	Operating principle D, with auxiliary key release, without actuator
Contact blocks			
18 [L]	FS 1896D024-M2   1NO+1NC 	FS 1896E024-M2   1NO+1NC 	FS 1898D024-M2   1NO+1NC 
20 [L]	FS 2096D024-M2   1NO+2NC 	FS 2096E024-M2   1NO+2NC 	FS 2098D024-M2   1NO+2NC 
21 [L]	FS 2196D024-M2   3NC 	FS 2196E024-M2   3NC 	FS 2198D024-M2   3NC 
28 [L]	FS 2896D024-M2   1NO+2NC 	FS 2896E024-M2   1NO+2NC 	FS 2898D024-M2   1NO+2NC 
29 [L]	FS 2996D024-M2   3NC 	FS 2996E024-M2   3NC 	FS 2998D024-M2   3NC 
30 [L]	FS 3096D024-M2   3NC 	FS 3096E024-M2   3NC 	FS 3098D024-M2   3NC 
Actuating force	30 N (40 N )	30 N (40 N )	30 N (40 N )

Legend: With positive opening according to EN 60947-5-1, interlock with lock monitoring acc. to EN ISO 14119

## How to read travel diagrams

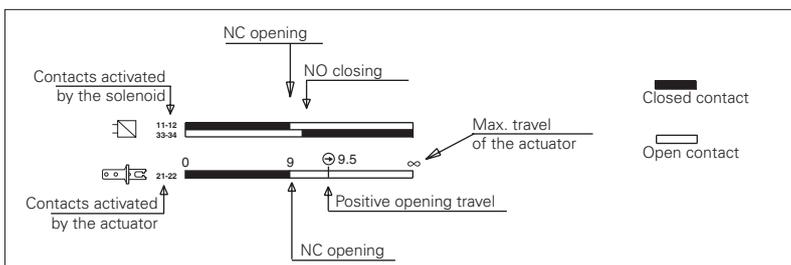

### IMPORTANT:

The state of the NC contact refers to the switch with inserted actuator and locked lock. In **safety applications**, actuate the switch **at least up to the positive opening travel** shown in the travel diagrams with symbol . Actuate the switch **at least with the positive opening force**, reported in brackets below each article, next to the actuating force value.

## Accessories

Article	Description
VF KB1	Lock out device

Padlockable lock out device to prevent the actuator entry and the accidental closing of the door behind operators while they are in the danger area. Hole diameter for padlocks: 9 mm.



Article	Description
VF KLA371	Set of two locking keys

Extra copy of the locking keys to be purchased if further keys are needed (standard supply: 2 units). The keys of all switches have the same code. Other codes on request.



## Stainless steel actuators

**IMPORTANT:** These actuators can be used only with items of the FD, FP, FL, FC, and FS series (e.g. FS 1896D024-M2).  
Low level of coding acc. to EN ISO 14119.

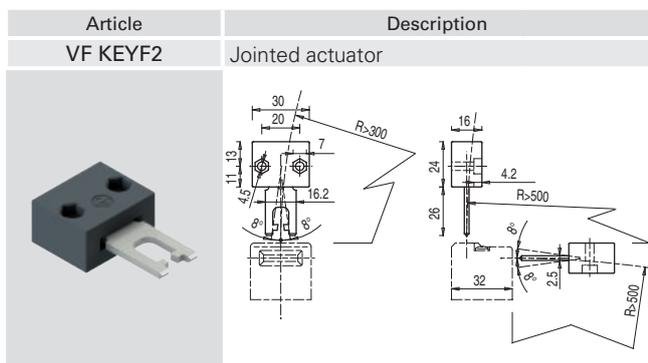
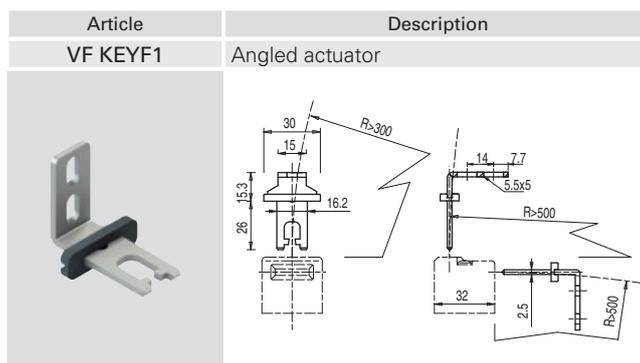
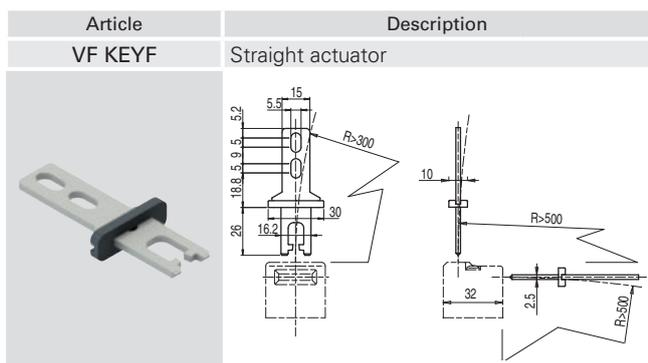

The actuator can flex in four directions for applications where the guard alignment is not precise.

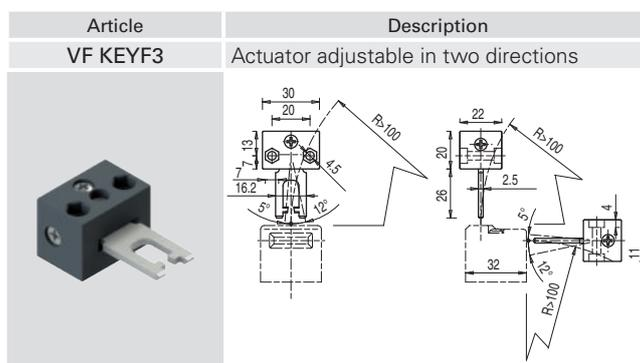

Actuator adjustable in two directions for guards with reduced dimensions.

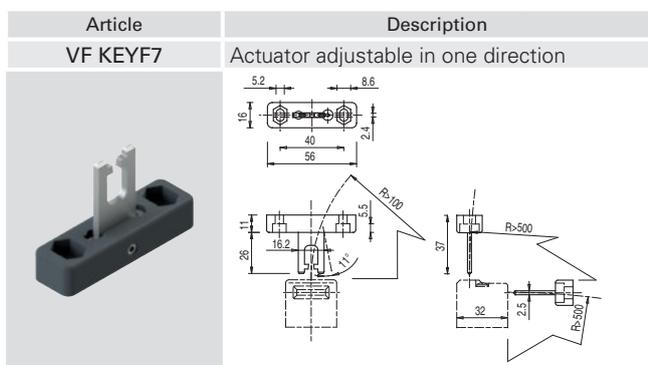

Actuator adjustable in one direction for guards with reduced dimensions.

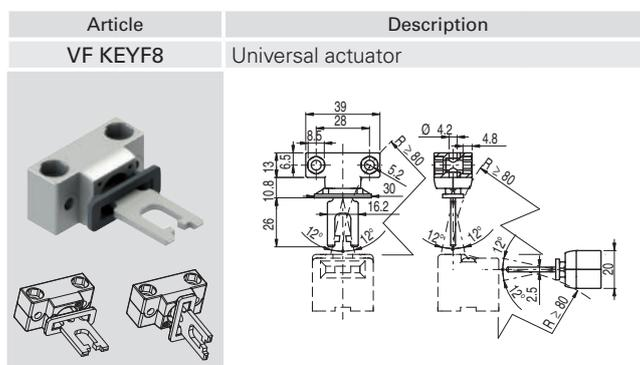

Jointed actuator for guards with poor alignment, adjustable in two dimensions for small doors; can be mounted in various positions. The metal fixing body has two pairs of bore holes; it is provided for rotating the working plane of the actuator by 90°.

## Description



These switches are used on machines where the hazardous conditions remain for a while, even after the machines have been switched off, for example because of mechanical inertia of pulleys, saw disks, parts under pressure or with high temperatures. Thus, the switches can also be used if individual guards are only to be opened under certain conditions.

Versions with mode 1 and 3 (safety outputs active when guard closed and locked) are interlocks with guard locking acc. to ISO 14119; the product is labelled with the symbol shown.



## Maximum safety with a single device

### PL e + SIL 3

The NG series switches are constructed with redundant electronics. As a result, the maximum PL e and SIL 3 safety levels can still be achieved through the use of a single device on a guard. This avoids expensive wiring in the field and allows faster installation. Inside the control cabinet, the two electronic safety outputs must be connected to a safety module with OSSD inputs or to a safety PLC.

## Series connection of several switches

### PL e + SIL 3

One of the most important features of the NG series is the possibility of connecting up to 32 sensors in series, while still maintaining the maximum safety levels PL e laid down in EN 13849-1 and SIL 3 acc. to EN 62061.

This connection type is permissible in safety systems which have a safety module at the end of the chain that monitors the outputs of the last NG switch. The fact that the PL e safety level can be maintained even with 32 sensors connected in series demonstrates the extremely secure structure of each single device.

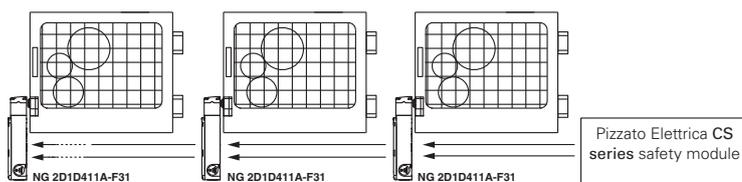

## Series connection with other devices

### PL e + SIL 3

The NG series features two safety inputs and two safety outputs, which can be connected in series with other Pizzato Elettrica safety devices. This option allows the creation of safety chains containing various devices. For example, stainless steel safety hinges (HX BEE1 series), transponder sensors (ST series) and door lock sensors (NG series) can be connected in series while still maintaining the maximum PL e and SIL 3 safety levels.

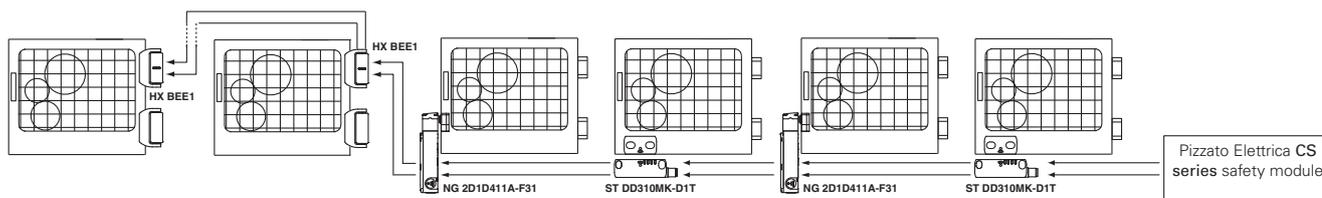

## RFID actuators with high coding level



The NG series is provided with an electronic system based on RFID technology to detect the actuator. This allows to provide each actuator with different coding and makes it impossible to tamper with a device by using another actuator of the same series. Millions of different coding combinations are possible for the actuators. They are therefore classified as high level coded actuators, according to EN ISO 14119.

The NG series is provided with an electronic system based on RFID technology to detect the actuator. This allows to provide each actuator with different coding and makes it impossible to tamper with a device by using another actuator of the same series. Millions of different coding combinations are possible for the actuators. They are therefore classified as high level coded actuators, according to EN ISO 14119.

## Holding force of the locked actuator

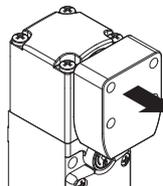

### 9750 N

The strong interlocking system guarantees a maximum actuator holding force of  $F_{Tmax} = 9750$  N. This is one of the highest values currently available on the market today, making this device suitable for heavy-duty applications.

## Dustproof

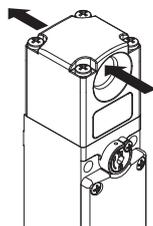

The switch is provided with a through hole for inserting the actuator. Thanks to this unique feature, any dust that enters the actuator hole can always come out on the opposite side instead of remaining inside. Moreover, the lock pin is provided with a diaphragm seal, making the system suitable for critical environments with a high level of dust.

## Integrated control devices

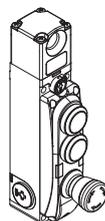

The switch is also available with elevated cover. Control devices such as buttons, emergency buttons, indicator lights or selectors can thereby be attached directly to the switch together with corresponding contact blocks.

The result is a compact solution with direct access to control devices without needing to install them separately on the switch panel or in their own housing. The devices can be illuminated and, thanks to the PUSH-IN spring-operated connections, wiring is quick and intuitive.

## Centring

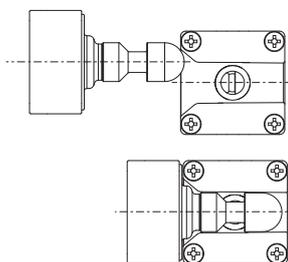

The switch is provided with a wide centring inlet for the actuator pin. This solution makes it easier to align the actuator and the opening hole on the head during installation. Moreover, this solution drastically reduces the probability of a collision between the switch and the actuator, making it possible to install the device even on inaccurately closing doors.

## Push-in spring-operated connections



The switch is provided with a PUSH-IN type spring-operated connection system on the inside. This technology allows wiring to be performed quickly and easily, as the wire just needs to be inserted into the appropriate hole in order to establish the electrical connection and automatically secure the wire. This operation can be performed with rigid or flexible wires with a crimped wire-end sleeve and requires no tools. Release is obtained by pressing the appropriate wire-releasing button.



### Six LEDs for immediate diagnosis



As the LEDs have been designed for quick immediate diagnosis, the status of each input and output is highlighted by one specific LED. This makes it possible to quickly identify the interruption points in the safety chain, which device is released, which door is opened and any errors inside the device. All of this at a glance, without needing to decode complex flashing sequences.

### Holding force of the unlocked actuator

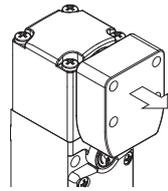

The inside of each switch features a device which holds the actuator in its closed position. Ideal for all those applications where several guards are unlocked simultaneously, but only one is actually opened. The device keeps all the unlocked guards in their position with a retaining force of approx. 30 N, stopping any vibrations or gusts of wind from opening them.

### Protection against tampering

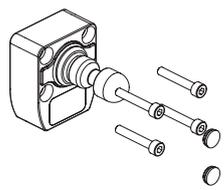

Each actuator of the NG series is supplied with four protection caps. Not only do the caps prevent dirt from accumulating and simplify cleaning, they also block access to the fastening screws of the actuator. As a result, standard screws can be used instead of tamper-proof screws.

### Jointed actuator for inaccurately closing guards

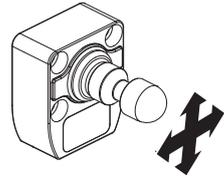

All NG series actuators are articulated, thereby allowing the actuator pin to be safely guided into the switch through the centring hole. As a result, the actuator and switch do not need to be precisely aligned during installation. In addition, the device can thereby be used on guards with a minimum actuation radius of 150 mm without the actuation pin needing to be angled.

### Function for protecting against recoil forces

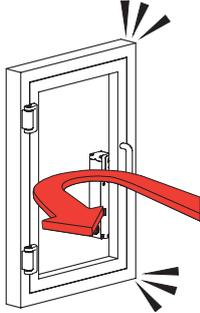

If a guard is closed too quickly or with so much force that the recoil would cause it to open again, a special function in the NG switch prevents locking. This function prevents the immediate locking of the guard if the lock signal is applied. This protects the switch against recoil forces that occur during instantaneous locking. This serves to protect the switch from damage and forces the operator to close the guard more gently.

### Head and devices with variable orientation

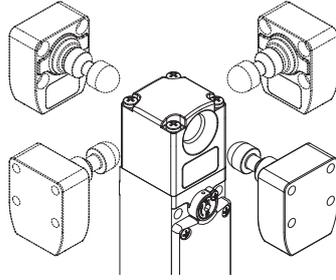

The system can be variably configured by loosening the 4 screws on the head. The key release device and the escape release button can also be rotated and secured independently of one another in steps of 90°. The device can thus assume 16 different configurations.

### Key release device and escape release button

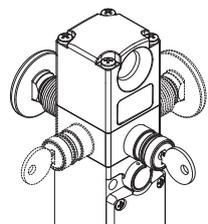

The key release device (auxiliary release) is used to permit unlocking of the actuator only by personnel in possession of the key. The device also functions with no power supply and, once actuated, prevents the guard from being locked.

The escape release button allows actuator release and immediate opening of the guard. Generally used in machines

within which an operator could inadvertently become trapped, it faces towards the machine interior, to allow the operator to exit even in the event of a power failure. The button has two stable states and can be freely extended in length with suitable extensions (see accessories). Both devices can be positioned on the four sides of the switch. As a result, it can be installed both towards the interior and towards the exterior of the machine.

### Non-detachable head and release devices

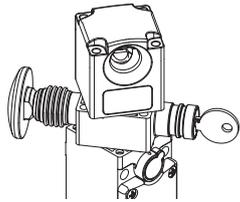

The head and the release device can be rotated but cannot be detached from each other. This makes the switch more secure since the problem of incorrect assembly by the installer cannot occur; in addition, the risk of damage is lower (loss of small parts, penetration of dirt, etc.).

### High protection degree

**IP69K**  
**IP67**

These devices are designed to be used in the toughest environmental conditions and they pass the IP67 immersion test acc. to EN 60529. They can therefore be used in all environments where maximum protection degree of the housing is required. Due to their special design, these devices are suitable for use in equipment subjected to cleaning with high pressure hot water jets. These devices meet the IP69K test requirements according to ISO 20653 (water jets with 100 bar and 80°C).

### Three safety output actuation modes

**MODE 1**  
**MODE 2**  
**MODE 3**

The device is available with 3 different actuation modes for safety outputs:

- mode 1: safety outputs active with inserted and locked actuator, for machines with inertia;
- mode 2: safety outputs active with inserted actuator, for machines without inertia;

- mode 3: a first safety output active with actuator inserted and locked and a second safety output active with actuator inserted, for special applications.

### External device monitoring

**EDM**

On request, the switch can be supplied with EDM function (External Device Monitoring). In this case, the switch itself checks the proper function of the devices connected to the safety outputs. These devices (usually relays or safety contactors) must send a feedback signal to the EDM input, which checks that the received signal is consistent with the state of the safety outputs.

Selection diagram

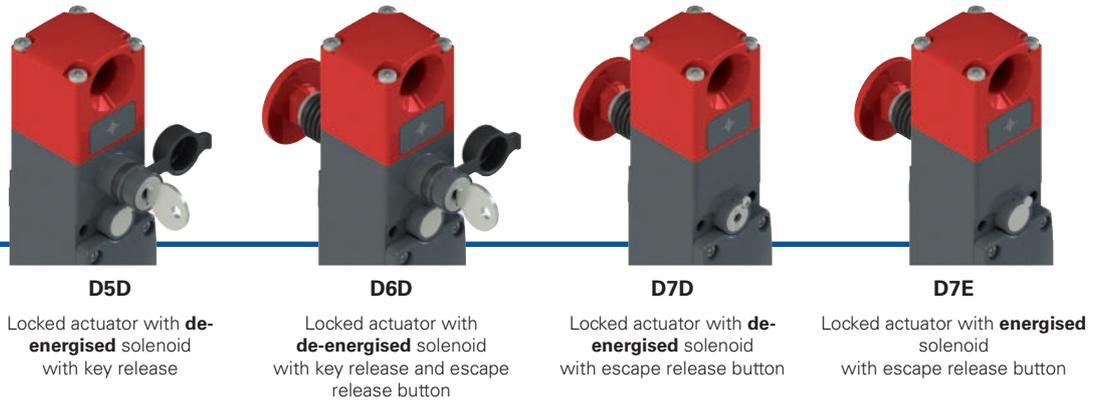

HEAD TYPE AND OPERATING PRINCIPLE

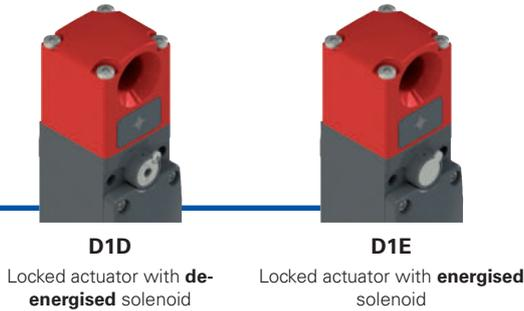

ACTUATORS

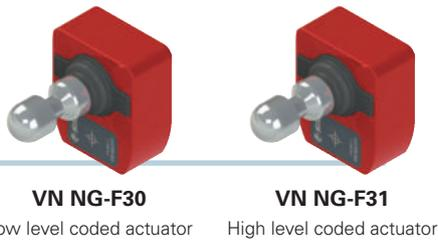

COVER CONFIGURATIONS

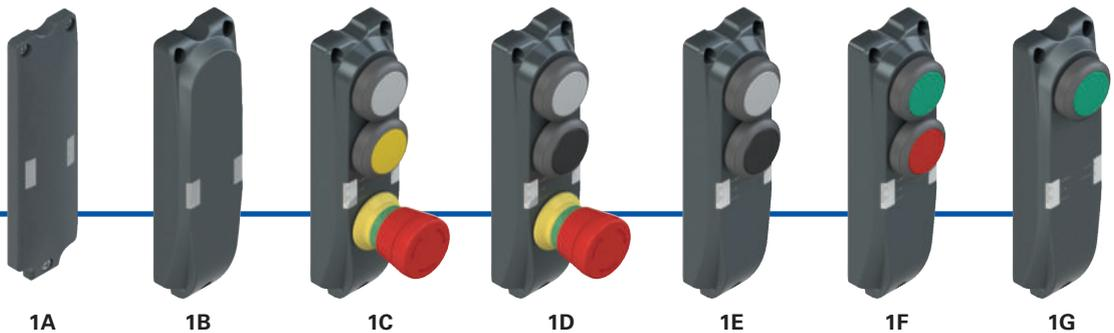

CONDUIT ENTRIES

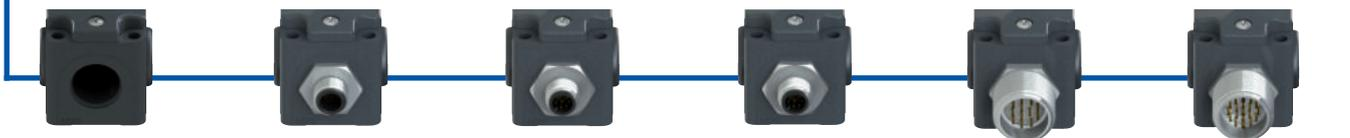

Threaded conduit entry M20

With M12 metal connector

With M12 metal connector for stand-alone connection

With M12 metal connector for series connection with "Y" connectors

With M23 metal connector (clockwise numbering)

With M23 metal connector (clockwise numbering)

<b>K110</b>	12-pole, bottom
<b>K111</b>	12-pole, right
<b>K112</b>	12-pole, left

<b>K953</b>	8-pole, bottom
<b>K954</b>	8-pole, right
<b>K955</b>	8-pole, left

<b>K950</b>	8-pole, bottom
<b>K951</b>	8-pole, right
<b>K952</b>	8-pole, left

<b>K900</b>	12-pole, bottom
<b>K901</b>	12-pole, right
<b>K902</b>	12-pole, left

<b>K601</b>	19-pole, bottom, configuration 1
<b>K602</b>	19-pole, bottom, configuration 2

.....  
.....

● product options  
→ Sold separately as accessory

**Code structure****Attention!** The feasibility of a code number does not mean the effective availability of a product. Please contact our sales office.

article
options

**NG 2D1D411A-F31E34K900LP30**

Operating principle	
<b>D1D</b>	locked actuator with de-energised solenoid
<b>D1E</b>	locked actuator with energised solenoid
<b>D5D</b>	locked actuator with de-energised solenoid. With key release
<b>D6D</b>	locked actuator with de-energised solenoid. With key release and escape release button
<b>D7D</b>	locked actuator with de-energised solenoid. With escape release button
<b>D7E</b>	locked actuator with energised solenoid. With escape release button

Inputs and outputs	
<b>3</b>	2 safety inputs IS1, IS2 2 safety outputs OS1, OS2 1 signalling output O3: actuator inserted 1 signalling output O4: actuator locked I4 or IE1/IE2 inputs for solenoid activation 1 reset input I3 <small>Note: Supplied only together with actuator</small>
<b>4</b>	2 safety inputs IS1, IS2 2 safety outputs OS1, OS2 1 signalling output O3: actuator inserted 1 signalling output O4: actuator locked I4 or IE1/IE2 inputs for solenoid activation 1 input I3: actuator programming / reset
<b>5</b>	2 safety inputs IS1, IS2 2 safety outputs OS1, OS2 1 signalling output O3: actuator inserted 1 signalling output O4: actuator locked I4 or IE1/IE2 inputs for solenoid activation 1 input I3: actuator programming / reset 1 feedback input EDM I5
<b>6</b>	2 safety inputs IS1, IS2 2 safety outputs OS1, OS2 1 signalling output O3: actuator inserted 1 signalling output FAULT O4 I4 or IE1/IE2 inputs for solenoid activation 1 input I3: actuator programming / reset

Activation of OS outputs	
<b>1</b>	mode 1: safety outputs OS1 and OS2 active with inserted and locked actuator
<b>2</b>	mode 2: safety outputs OS1 and OS2 active with inserted actuator
<b>3</b>	mode 3: safety output OS1 active with inserted and locked actuator, safety output OS2 active with inserted actuator

Release button length	
	for max. 15 mm wall thickness (standard)
<b>LP30</b>	for max. 30 mm wall thickness
<b>LP40</b>	for max. 40 mm wall thickness
<b>LP50</b>	for max. 50 mm wall thickness
<b>LP60</b>	for max. 60 mm wall thickness
...	other wall thicknesses on request

Pre-installed connectors	
	without connector (standard)
<b>K110</b>	M12 metal connector, 12-pole, bottom
<b>K601</b>	M23 metal connector, 19-pole, bottom, configuration 1
<b>K900</b>	M23 metal connector, 12-pole, bottom
<b>K950</b>	M12 metal connector, 8-pole, bottom, for series connection
...	other connectors on request

For the complete list of possible combinations please contact our technical department.

Actuator extraction force	
	actuator extraction force 30 N (standard)
<b>E34</b>	actuator freely removable

Actuator	
<b>F30</b>	low level coded actuator VN NG-F30 the switch recognises any type F30 actuator
<b>F31</b>	high level coded actuator VN NG-F31 the switch recognises one single type F31 actuator

Cover configurations	
<b>1A</b>	low cover (standard)
<b>1B</b>	raised cover without holes
<b>1C</b>	cover with white button / yellow button / emergency button with rotary release
<b>1D</b>	cover with white button / black button / emergency button with rotary release
<b>1E</b>	cover with white button / black button
<b>1F</b>	cover with green button / red button
<b>1G</b>	cover with green button
...	other configurations on request

**Code structure for actuator****VN NG-F30**

Actuator	
<b>F30</b>	low level coded actuator the switch recognises any type F30 actuator
<b>F31</b>	high level coded actuator the switch recognises one single type F31 actuator



### Main features

- Actuation without contact, using RFID technology
- Digitally coded actuator
- Actuator holding force: 9750 N
- SIL 3 and PL e with a single device
- Metal housing, three M20 conduit entries
- Protection degree up to IP67 and IP69K
- PL e also with series connection of up to 32 devices
- Signalling LED

### Quality marks:



EC type examination certificate: M6A180475157023  
 UL approval: E131787  
 TÜV SÜD approval: Z10 18 04 75157 022  
 EAC approval: RU C-IT.YT03.B.00035/19

### In compliance with standards:

EN ISO 14119, EN 60947-5-3, EN 60947-1, IEC 60204-1, EN 60204-1, EN ISO 12100, IEC 60529, EN 60529, EN 61000-6-2, EN 61000-6-3, BG-GS-ET-19, IEC 61508-1, IEC 61508-2, IEC 61508-3, IEC 61508-4, SN 29500, EN ISO 13849-1, EN ISO 13849-2, EN 62061, EN 61326-1, EN 61326-3-1, EN 61326-3-2, EN 50581, ETSI 301 489-1, ETSI 301 489-3, ETSI 300 330-2, UL 508, CSA 22.2 No. 14

### Compliance with the requirements of:

Machinery Directive 2006/42/EC, EMC Directive 2014/30/EC, RED Directive 2014/53/EU, RoHS directive 2011/65/EU, FCC Part 15.

### Features approved by UL

Electrical Ratings: 24 Vdc, 0,25 A.  
 Input supplied by Class 2 source or limited voltage limited energy.  
 Environmental Ratings: Types 1, 4X, 12, 13 (versions without control devices), Type 1 (versions with control devices).

### Features approved by TÜV SÜD

Protection degree: IP67, IP69K  
 Ambient temperature: -20°C...+50°C  
 Storage temperature: -40°C...+75°C  
 PL, category: PL e, cat. 4  
 SIL: SIL 3 / SIL CL 3

In compliance with standards: 2006/42/EC, EN 60947-1:2007/A2:2014, EN 60947-5-2:2007/A1:2012, EN 60947-5-3:2013, EN ISO 14119:2013, EN 61508-1:2010 (SIL 3), EN 61508-2:2010 (SIL 3), EN 61508-3:2010 (SIL 3), EN 61508-4:2010 (SIL 3), EN 62061:2005/A2:2015 (SIL CL 3), EN ISO 13489-1:2015 (PL e, Cat 4).

Please contact our technical department for the list of approved products.

### Technical data

Metal head and housing, baked powder coating.  
 Three threaded conduit entries:  
 Protection degree:

M20x1.5  
 IP67 acc. to EN 60529,  
 IP69K acc. to ISO 20653  
 IP65 acc. to EN 60529 with cable gland of equal or higher protection degree

Protection degree with control devices:

### General data

Safety parameters	SIL	PL	Cat.	DC	PFH <sub>0</sub>	MTTF <sub>0</sub>
Monitoring function: actuator locked - Mode 1	3	e	4	High	1,15E-09	2968
Monitoring function: actuator present - Mode 2	3	e	4	High	1,15E-09	3946
Monitoring function: actuator locked - Mode 3	2	d	2	High	1,48E-09	2957
Monitoring function: actuator present - Mode 3	2	d	2	High	1,48E-09	3927
Dual-channel control for locking function of the actuator	3	e	4	High	1,51E-10	4011
Single-channel control for locking function of the actuator	2	d	2	High	1,51E-10	4011

Interlock with lock, no contact, coded: type 4 acc. to EN ISO 14119  
 Level of coding acc. to EN ISO 14119: low with F30 actuator  
 High with F31 actuator

Mission time: 20 years  
 Ambient temperature: -20°C ... +50°C

Max. actuation frequency with actuator lock and release: 600 operating cycles/hour  
 Mechanical endurance: 1 million operating cycles  
 Max. actuation speed: 0.5 m/s  
 Min. actuation speed: 1 mm/s  
 Maximum force before breakage  $F_{1max}$ : 9750 N acc. to EN ISO 14119  
 Max. holding force  $F_{2h}$ : 7500 N acc. to EN ISO 14119  
 Maximum clearance of locked actuator: 4 mm  
 Released actuator extraction force: ~ 30 N

### Power supply electrical data

Rated operating voltage  $U_{0}$ : 24 Vdc  $\pm$ 10% SELV  
 Operating current at  $U_{0}$  voltage: 40 mA min.; 0.4 A with activated solenoid;  
 1.2 A with activated solenoid and all outputs at maximum power

Rated insulation voltage  $U_i$ : 32 Vdc  
 Rated impulse withstand voltage  $U_{imp}$ : 1.5 kV  
 External protection fuse: 2 A type gG or equivalent device  
 Overvoltage category: III  
 Solenoid duty cycle: 100% ED (continuous operation)  
 Solenoid consumption: 9 W max.  
 Pollution degree: 3 acc. to EN 60947-1

### Electrical data of IS1/IS2/I3/I4/I5/IE1/IE2/EDM inputs

Rated operating voltage  $U_{01}$ : 24 Vdc  
 Rated current consumption  $I_{01}$ : 5 mA

### Electrical data of OS1/OS2 safety outputs

Rated operating voltage  $U_{02}$ : 24 Vdc  
 Output type: PNP type OSSD  
 Maximum current per output  $I_{02}$ : 0.25 A  
 Minimum current per output  $I_{m2}$ : 0.5 mA  
 Thermal current  $I_{th2}$ : 0.25 A  
 Utilization category: DC13;  $U_{02}$ =24 Vdc,  $I_{02}$ =0.25 A  
 Short circuit detection: Yes  
 Overcurrent protection: Yes  
 Internal self-resettable protection fuse: 1.1 A  
 Duration of the deactivation impulses at the safety outputs: < 300  $\mu$ s  
 Permissible maximum capacitance between outputs: < 200 nF  
 Permissible maximum capacitance between output and ground: < 200 nF  
 Activation time of safety outputs OS1 and OS2 after deactivation of inputs IS1, IS2: typically 7 ms, max. 15 ms  
 Activation time upon unlocking the guard: typically 7 ms, max. 12 ms  
 Maximum delay of EDM status change: 500 ms

### Electrical data of O3/O4 signalling output

Rated operating voltage  $U_{03}$ : 24 Vdc  
 Output type: PNP  
 Maximum current per output  $I_{03}$ : 0.1 A  
 Utilization category: DC13;  $U_{03}$ =24 Vdc,  $I_{03}$ =0.1 A  
 Short circuit detection: No  
 Overcurrent protection: Yes  
 Internal self-resettable protection fuse: 1.1 A

### RFID sensor data

Assured operating distance  $S_{ao}$ : 2 mm  
 Assured release distance  $S_{ar}$ : 4 mm (actuator not locked)  
 10 mm (actuator locked)  
 Rated operating distance  $S_n$ : 2.5 mm  
 Repeat accuracy:  $\leq$  10 %  $s_n$   
 Differential travel:  $\leq$  20 %  $s_n$   
 RFID transponder frequency: 125 kHz  
 Max. switching frequency: 1 Hz





## Actuation mode of the OS1 and OS2 safety outputs

Mode 1	Mode 2	Mode 3
Safety outputs OS1 and OS2 are active when the actuator is inserted and locked.	Safety outputs OS1 and OS2 are active when the actuator is inserted.	Safety output OS1 is active when the actuator is inserted and locked and IS1 is active. Safety output OS2 is active when the actuator is inserted and IS2 is active.
In case of machines with or without inertia of the dangerous elements. Safety category of the safety outputs: PL e, SIL 3.	In case of machines without inertia of the dangerous elements. Safety category of the safety outputs: PL e, SIL 3.	In case of machines with or without inertia of the dangerous elements. Safety category of the safety outputs: PL d, SIL 2.

## Selection table for switches with high level coded actuators

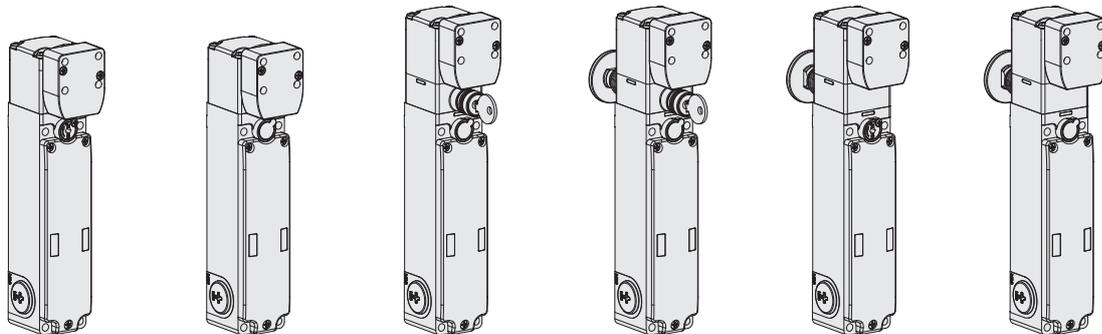

Operating principle	Locked actuator with de-energised solenoid. With sealable auxiliary release device	Locked actuator with energised solenoid.	Locked actuator with de-energised solenoid. With key release.	Locked actuator with de-energised solenoid. With key release and escape release button.	Locked actuator with de-energised solenoid. With escape release button and sealable auxiliary release device.	Locked actuator with energised solenoid. With escape release button.
Mode 1	NG 2D1D411A-F31	NG 2D1E411A-F31	NG 2D5D411A-F31	NG 2D6D411A-F31	NG 2D7D411A-F31	NG 2D7E411A-F31
Mode 2	NG 2D1D421A-F31	NG 2D1E421A-F31	NG 2D5D421A-F31	NG 2D6D421A-F31	NG 2D7D421A-F31	NG 2D7E421A-F31
Mode 3	NG 2D1D431A-F31	NG 2D1E431A-F31	NG 2D5D431A-F31	NG 2D6D431A-F31	NG 2D7D431A-F31	NG 2D7E431A-F31

## Selection table for switches

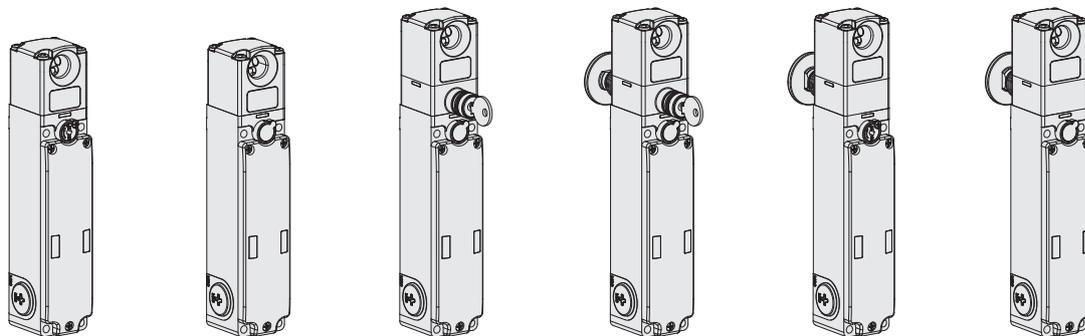

Operating principle	Locked actuator with de-energised solenoid. With sealable auxiliary release device	Locked actuator with energised solenoid.	Locked actuator with de-energised solenoid. With key release.	Locked actuator with de-energised solenoid. With key release and escape release button.	Locked actuator with de-energised solenoid. With escape release button and sealable auxiliary release device.	Locked actuator with energised solenoid. With escape release button.
Mode 1	NG 2D1D411A	NG 2D1E411A	NG 2D5D411A	NG 2D6D411A	NG 2D7D411A	NG 2D7E411A
Mode 2	NG 2D1D421A	NG 2D1E421A	NG 2D5D421A	NG 2D6D421A	NG 2D7D421A	NG 2D7E421A
Mode 3	NG 2D1D431A	NG 2D1E431A	NG 2D5D431A	NG 2D6D431A	NG 2D7D431A	NG 2D7E431A

To order a product with EDM input replace number 4 with number 5 in the codes shown above. Example: NG 2D1D411A → NG 2D1D511A

Legend: interlock with lock monitoring acc. to EN ISO 14119

## Selection table for actuators



The use of RFID technology in NG series devices makes them suitable for several applications. Pizzato Elettrica offers two different versions of actuators, in order to best suit customers' specific needs.

Type F30 actuators are all encoded with the same code. This implies that a device associated with an actuator type F30 can be activated by other actuators type F30.

Type F31 actuators are always encoded with different codes. This implies that a device associated with an actuator type F31 can be activated only by a specific actuator. Another F31 type actuator will not be recognized by the device until a new association procedure is carried out (reprogramming). After reprogramming, the old actuator F31 will no longer be recognized.

Reprogramming of the actuator can be performed repeatedly.

Level of coding acc. to EN ISO 14119	Article
low	VN NG-F30
high	VN NG-F31

## Complete safety system

The use of complete and tested solutions guarantees the electrical compatibility between the NG series switches and the safety modules from Pizzato Elettrica, as well as high reliability. The switches have been tested with the modules listed in the adjacent table.

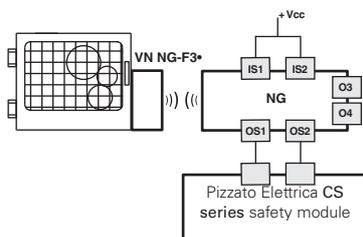

NG series switches can be used as individual devices provided that the safety outputs be evaluated by a Pizzato Elettrica safety module (see table for combinable safety modules).

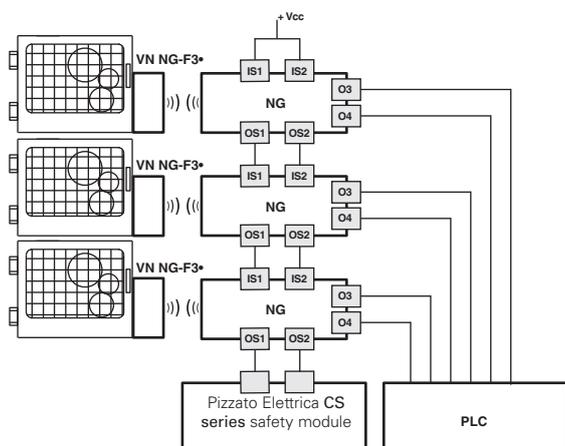

Possibility of series connection of multiple switches for simplifying the wiring of the safety system, whereby only the outputs of the last switch are evaluated by a Pizzato Elettrica safety module (see table with compatible safety modules). Each NG series switch is provided with two signalling outputs which are activated when the guard is closed (O3) or locked (O4). Depending on the specific requirements of the system that has been realised, the signals of the signalling outputs can be evaluated by a PLC.

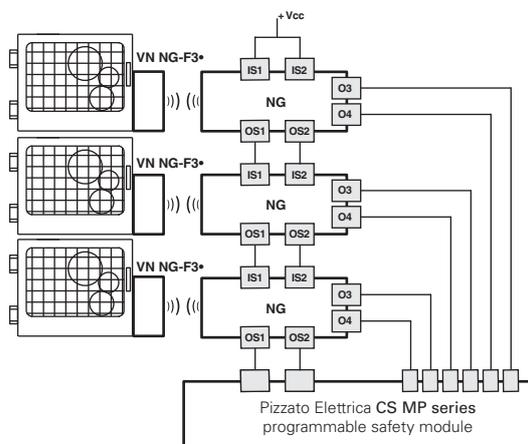

Possibility of series connection of multiple switches for simplifying the wiring of the safety system, whereby only the outputs of the last switch are evaluated by a Pizzato Elettrica safety module of the CS MP series. Both the safety-relevant evaluation and the evaluation of the signalling outputs are performed by the CS MP series.

The examples listed above refer to applications with NG 2•••4•••

Switches	Compatible safety modules	Safety module output contacts		
		Instantaneous safety contacts	Delayed safety contacts	Signalling contacts
NG 2••••••	CS AR-05•••••	3NO	/	1NC
	CS AR-06•••••	3NO	/	1NC
	CS AR-08•••••	2NO	/	/
	CS AT-0•••••	2NO	2NO	1NC
	CS AT-1•••••	3NO	2NO	/
	CS MP•••••			

page 277

page 305

All NG series switches can be connected to safety modules or safety PLCs with OSSD inputs provided compatibility is ensured in advance.

## Internal block diagram

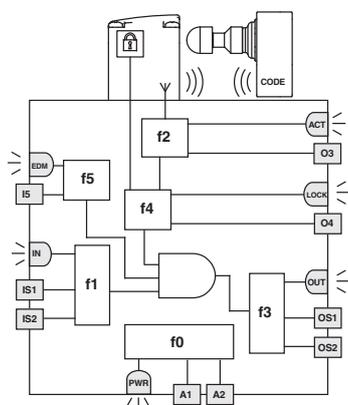

LED	Function
PWR	Power supply / self-diagnosis
IN	status of safety inputs
OUT	status of safety outputs
ACT	actuator state
LOCK	actuator locked
EDM	state of EDM input (NG 2D•••5•••)

The diagram on the side represents the 6 logic functions which interact inside the device.

Function f0 is a basic function and includes the monitoring of the power supply as well as internal, cyclical tests.

Function f1 monitors the status of the device inputs, whereas function f2 monitors the presence of the actuator within the detection areas of the switch.

Function f4 checks the actuator lock condition.

Function f3 is intended to activate or deactivate the safety outputs and check for any faults or short circuits in the outputs.

In the EDM versions, the f5 function verifies the consistency of the EDM signal during safety output state changes.

The safety-related function, which combines the sub-functions mentioned above, activates the safety outputs according to the chosen operating mode:

- Both safety outputs OS1/OS2 for switches in mode 1 are activated only if both IS1/IS2 safety inputs are active and the actuator is inserted and locked;
- Both safety outputs OS1/OS2 for switches in mode 2 are activated only if both IS1/IS2 safety inputs are active and the actuator is inserted;
- The safety output OS1 for switches in mode 3 is activated only if the IS1 safety input is active and the actuator is inserted and locked, whereas the safety output OS2 is activated only if the IS2 safety input is active and the actuator is inserted.

The status of each function is displayed by the corresponding LED (PWR, IN, OUT, ACT, LOCK, EDM), in such a way that the general device status becomes immediately obvious to the operator.



### Actuation sequence in mode 1

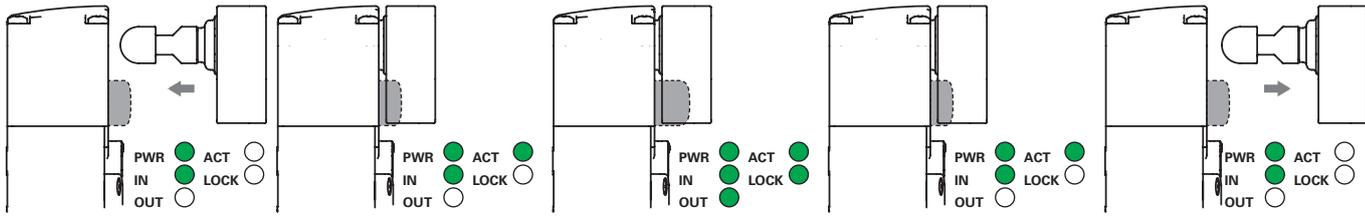

The switch is supplied with power (PWR LED on, green), the IS1 and IS2 inputs are enabled (IN LED on, green), the OS1 and OS2 safety outputs are disabled (OUT LED off). The actuator is outside of the actuation zone (LED ACT off).

When the actuator is brought inside the safe actuation area (dark grey area), the switch turns on the ACT LED (green). In this position, the O3 signalling output (door-closed) is activated. The actuator is not locked (LOCK LED off).

The I4 input can be used to lock the actuator (LOCK LED on, green). The OS1 and OS2 safety outputs are enabled (OUT LED on, green). The O4 signalling output is activated at the same time. The safe actuation area is extended in order to allow greater play for the actuator.

The I4 input can be used to unlock the actuator (LOCK LED off). The switch disables the OS1 and OS2 safety outputs and turns off the OUT LED. The O4 signalling output is deactivated at the same time. The safe actuation area returns to the initial values.

When the actuator leaves the actuation limit area, the device turns off the ACT LED and the O3 signalling output.

### Actuation sequence in mode 2 and mode 3

In contrast to the above mode 2 description, the safety outputs OS1 and OS2 are activated when the actuator is detected, and deactivated when the actuator is no longer detectable, in mode 3, the OS1 safety output is active with inserted and locked actuator and IS1 active, the OS2 safety output is active with inserted actuator and IS2 active.

#### Operating states

PWR LED	IN LED	OUT LED	ACT LED	LOCK LED	EDM LED (a)	Device state	Description
○	○	○	○	○	○	OFF	Device switched off.
●	●	●	●	●	●	POWER ON	Internal tests upon activation.
●	○	○	*	*	●	RUN	Safety inputs of the device not active.
●	●	*	*	*	*	RUN	Activation of safety inputs.
●	●	○	*	*	*	RUN	Safety inputs incoherence. Recommended action: check for presence and/or wiring of inputs.
●	*	*	●	*	*	RUN	Actuator in safe area. O3 signalling output active.
●	*	*	●	●	○	RUN	Actuator in safe area and locked; O3 and O4 outputs active.
●	●	●	●	●	○	RUN	<b>Mode 1</b> Activation of safety inputs IS1, IS2. Actuator in safe area and locked. O3, O4, OS1 and OS2 outputs active.
●	●	●	●	*	○	RUN	<b>Mode 2</b> Activation of safety inputs IS1, IS2. Actuator in safe area. O3, OS1 and OS2 outputs active.
●	●	○	●	●	○	RUN	<b>Mode 3.</b> Actuator present, guard closed and locked, IS1 enabled, IS2 disabled, OS1 enabled, OS2 disabled
●	●	○	●	○	○	RUN	<b>Mode 3.</b> Actuator present, guard closed and not locked, IS1 and IS2 enabled, OS1 disabled, OS2 enabled
●	*	●	*	*	*	ERROR	Error on safety outputs. Recommended action: check for any short circuits between the outputs, outputs and ground or outputs and power supply, then restart the device.
●	○	○	●	○	○	ERROR	Actuator detection error. Check the physical integrity of the device and, in case of failure, please replace the entire device. If undamaged, realign the actuator with the switch and restart the device.
●	○	○	○	○	○	ERROR	Internal error. Recommended action: restart the device. If the failure persists, replace the device.
●	*	○	*	*	●	RUN	EDM signal active (external relay off) <sup>a</sup>
●	●	●	●	●	○	RUN	EDM signal not active (external relay on) <sup>a</sup>
●	○	○	○	○	●	ERROR	Error in the EDM <sup>a</sup> function

Legend: ○ = off ● = on ● = flashing ● = alternating colours \* = indifferent  
(a) Available for NG 2D●●5●● versions only

#### External device monitoring (EDM)

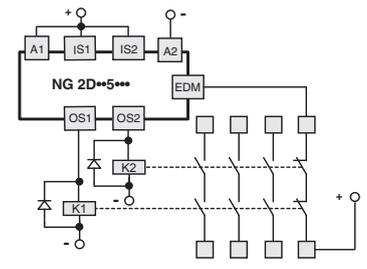

The NG 2D●●5●● version, in addition to maintaining the operating and safety characteristics of the NG series, allows control of **forcibly guided NC contacts of contactors or relays** controlled by the safety outputs of the switch itself. As an alternative to the relays or contactors you can use Pizzato Elettrica expansion modules CS ME-03. See page 267. This check is carried out via the EDM input (External Device Monitoring as defined in EN 61496-1) of the switch.

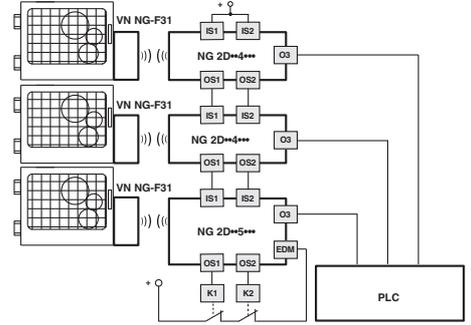

This version, with the IS safety inputs, **can be used at the end of a series of NG switches, up to a maximum number of 32 devices**, while maintaining the maximum PL e safety level and acc. to EN ISO 13849-1 and SIL 3 safety level acc. to EN 62061.

This solution allows you to dispense with the safety module connected to the last device in the chain.

## Connection with safety modules

Connections with CS AR-08 safety modules

Input configuration with monitored start  
2 channels / Category 4 / up to SIL 3 / PL e

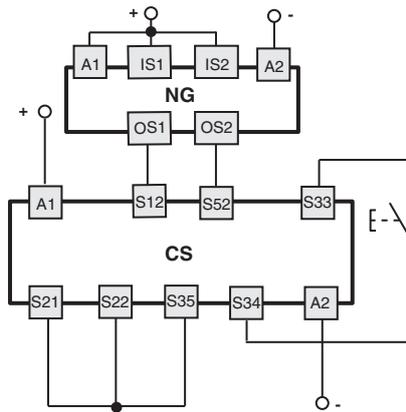

Connections with CS AR-05 / CS AR-06 safety modules

Input configuration with manual start (CS AR-05) or monitored start (CS AR-06)  
2 channels / Category 4 / up to SIL 3 / PL e

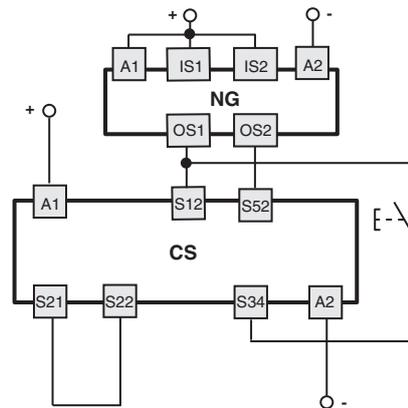

Connections with CS AT-0 / CS AT-1 safety modules

Input configuration with monitored start  
2 channels / Category 4 / up to SIL 3 / PL e

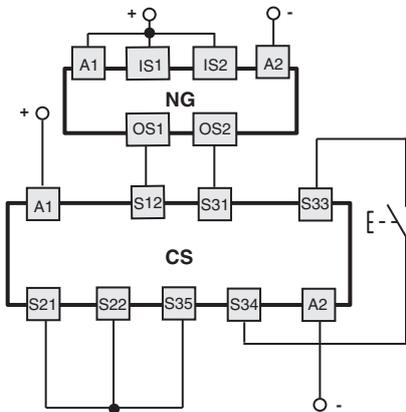

Connections with CS MF, CS MP safety modules

The connections vary according to the program of the module  
Category 4 / up to SIL 3 / PL e

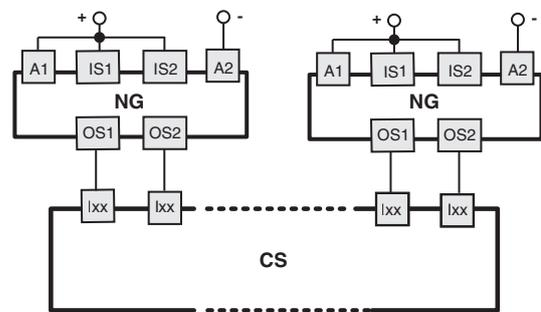

Application example on page 275.

## Series connection of several switches

Monitoring function: actuator locked  
2 channels / Category 4 / up to SIL 3 / PL e

Single-channel control for locking function of the actuator  
1 channel / Category 2 / up to SIL 2 / PL d

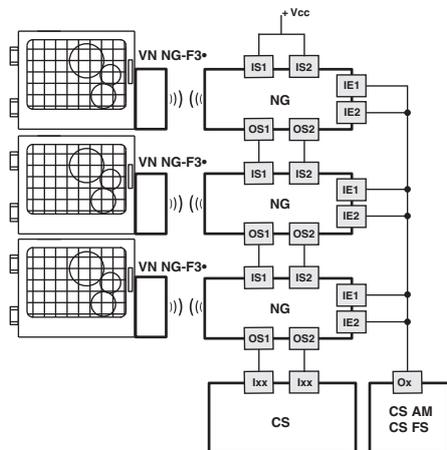

Monitoring function: actuator locked  
2 channels / Category 4 / up to SIL 3 / PL e

Dual-channel control for locking function of the actuator  
2 channels / Category 4 / up to SIL 3 / PL e

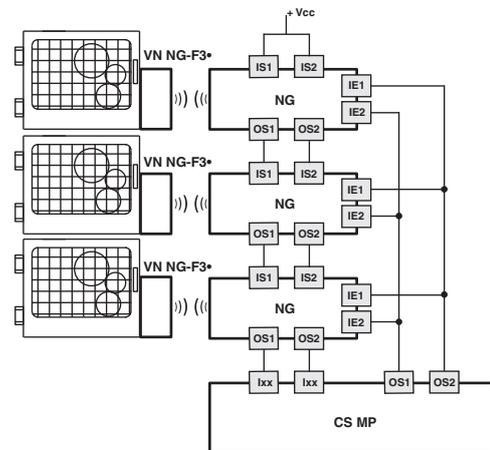

## Connection terminals

PUSH-IN type spring-operated connection system

Cross-section of rigid/flexible wires w. wire-end sleeve:

min. 1 x 0.34 mm<sup>2</sup> (1 x AWG 22)  
max. 1 x 1.5 mm<sup>2</sup> (1 x AWG 16)

Wire cross-section with pre-insulated wire-end sleeve:

min. 1 x 0.34 mm<sup>2</sup> (1 x AWG 22)  
max. 1 x 0.75 mm<sup>2</sup> (1 x AWG 18)

Cable stripping length (x):

min.: 8 mm  
max.: 12 mm

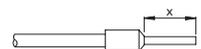



### Pin assignments (version with standard cover NG 2D••••1A)

Internal terminal strip	M23 connector 12-pole	M12 connector, 12-pole	M12 connector, 8-pole stand-alone connection	M12 connector, 8-pole series connection with "Y" connectors	Connection
A2	3	3	3	3	<b>A2</b> Supply input 0 V
B2	3	3	3	3	<b>B2</b> 0 V auxiliary supply output
I4	10	10	8	8	<b>I4</b> Solenoid activation input for single channel mode (c)
O3	5	5	2	/	<b>O3</b> Signalling output, actuator inserted (e)
O4	9	9	5	5 (f)	<b>O4</b> Signalling output, actuator inserted and locked (b) (e)
I3	8	8	6	/	<b>I3</b> Actuator programming input / reset
IE1	10	10	/	/	<b>IE1</b> Solenoid activation input for double channel mode
IE2	12	12	/	/	<b>IE2</b> Solenoid activation input for double channel mode (d)
A1	1	1	1	1	<b>A1</b> Supply input +24 Vdc
B1	1	1	1	1	<b>B1</b> Auxiliary supply output +24 Vdc, 8 A max.
IS1	2	2	/	2	<b>IS1</b> Safety input
IS2	2	2	/	2	<b>IS2</b> Safety input
I5	6	6	/	6	<b>IS2</b> Safety input
OS1	11	11	/	/	<b>I5</b> EDM input (a)
OS2	4	4	4	4	<b>OS1</b> Safety output
	7	7	7	7	<b>OS2</b> Safety output

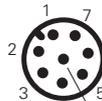
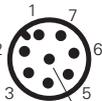
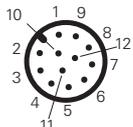
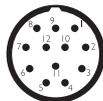
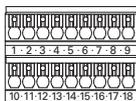
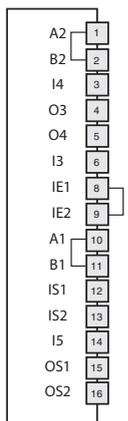

Important: terminals 7, 17, 18, of the internal terminal strip must not be used.

- (a) Available in NG 2D•••5••• version only.
- (b) For NG 2D•••6•••: the output signals the fault condition of the device.
- (c) In single-channel actuation mode, inputs IE1 and IE2 must be short-circuited.
- (d) In double-channel actuation mode, remove the internal bridge between terminals 8-9 and connect the pin 12 wire to the internal terminal 9.
- (e) For NG 2D•••7••• articles: the signalling outputs O3 and O4 have negative operating logic (low active signal).
- (f) Available for 8-pole connector, not available for the end of a chain with Y connectors.

Female connectors See page 321

### Dimensional drawings

Switch NG 2D1D••1A  
Operating principle D, with sealable auxiliary release device, without actuator

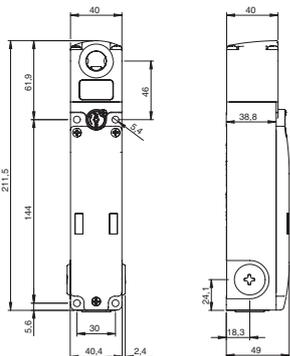

Switch NG 2D1E••1A  
Operating principle E, without actuator

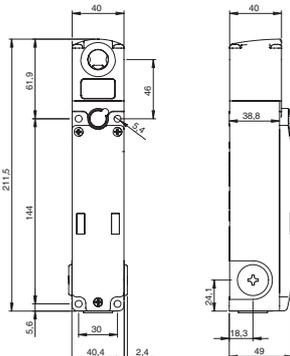

Switch NG 2D5D••1A  
Operating principle D, with key release, without actuator

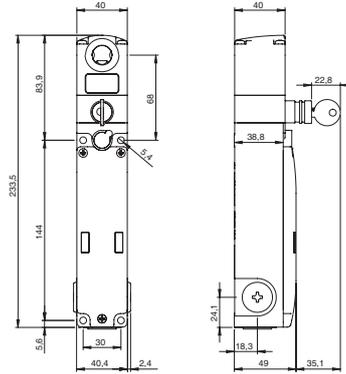

Switch NG 2D6D••1A  
Operating principle D, with key release and escape release button, without actuator

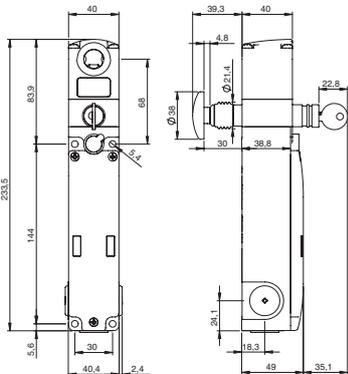

Switch NG 2D7D••1A  
Operating principle D, with escape release button, without actuator

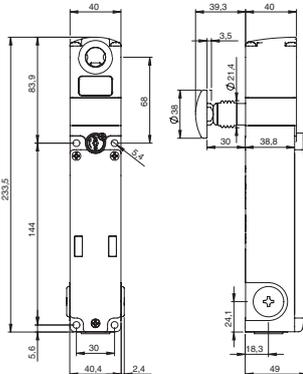

Switch NG 2D7E••1A  
Operating principle E, with escape release button, without actuator

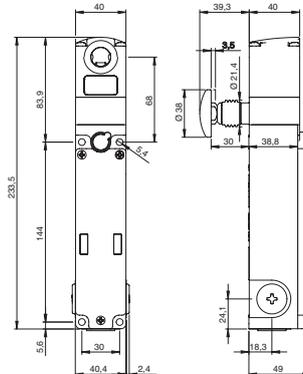

### Actuator VN NG-F3•

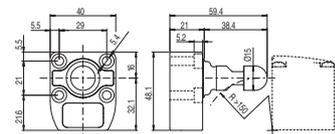

All values in the drawings are in mm

Accessories See page 321

➔ The 2D and 3D files are available at [www.pizzato.com](http://www.pizzato.com)

## Switch with integrated field-wireable control devices

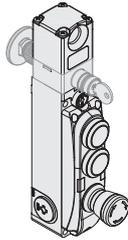
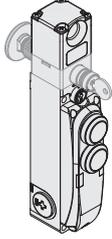
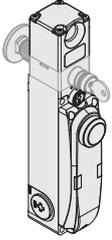
	NG 2D••••1C			NG 2D••••1D			NG 2D••••2V		
	Description	Colour	Terminals	Description	Colour	Terminals	Description	Colour	Terminals
	Device 1	illuminated button, spring-return 1NO+1NC	white	Device 1	illuminated button, spring-return 1NO+1NC	white	Device 1	illuminated button, spring-return 1NO+1NC	white
	Device 2	illuminated button, spring-return 1NO+1NC	yellow	Device 2	button, not illuminated, spring-return 1NO+1NC	black	Device 2	illuminated button, spring-return 1NO+1NC	blue
	Device 3	emergency button, not illuminated, with rotary release 2NC	red	Device 3	emergency button, not illuminated, with rotary release 2NC	red	Device 3	emergency button, not illuminated, with rotary release 2NC	red
	NG 2D••••1E			NG 2D••••1F			NG 2D••••7F		
	Device 1	illuminated button, spring-return 1NO+1NC	white	Device 1	illuminated button, spring-return 1NO+1NC	green	Device 1	illuminated button, spring-return 1NO+1NC	white
	Device 2	button, not illuminated, spring-return 1NO+1NC	black	Device 2	illuminated button, spring-return 1NO+1NC	red	Device 2	illuminated button, spring-return 1NO+1NC	blue
	NG 2D••••1G			NG 2D••••1H			NG 2D••••3G		
	Device 1	illuminated button, spring-return 1NO+1NC	green	Device 1	illuminated button, spring-return 1NO+1NC	white	Device 1	illuminated button, spring-return 1NO+1NC	blue

## Internal connections (version with integrated control devices)

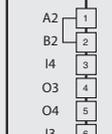
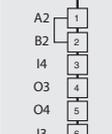
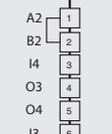
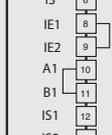
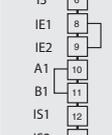
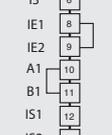
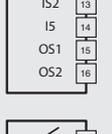
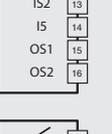
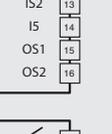
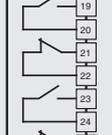
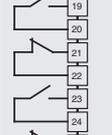
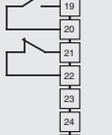
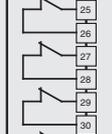
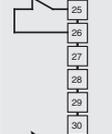
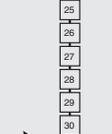
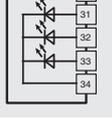
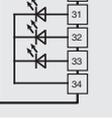
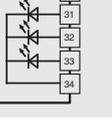
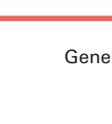
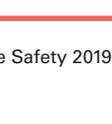
Terminal no.	Connection	NG 2D••••1C NG 2D••••1D NG 2D••••2V		NG 2D••••1E NG 2D••••1F NG 2D••••7F		NG 2D••••1G NG 2D••••1H NG 2D••••3G	
		Diagram	Diagram	Diagram	Diagram		
1	A2 Supply input 0 V						
2	B2 0 V auxiliary supply output						
3	I4 Solenoid activation input for single channel mode (c)						
4	O3 Signalling output, actuator inserted (d)						
5	O4 Signalling output, actuator inserted and locked (b) (d)						
6	I3 Actuator programming input / reset						
8	IE1 Solenoid activation input for double channel mode						
9	IE2 Solenoid activation input for double channel mode						
10	A1 Supply input +24 Vdc						
11	B1 Auxiliary supply output +24 Vdc, 1.5 A max.						
12	IS1 Safety input						
13	IS2 Safety input						
14	I5 EDM input (a)						
15	OS1 Safety output						
16	OS2 Safety output						

Important: terminals 7, 17, 18, of the internal terminal strip must not be used.

(a) Available in NG 2D••••5••• version only.

(b) For NG 2D••••6•••: the output signals the fault condition of the device.

(c) In single-channel actuation mode, inputs IE1 and IE2 must be short-circuited.

(d) For NG 2D••••7••• articles: the signalling outputs O3 and O4 have negative operating logic (low active signal).

Internal terminal strip integrated control devices

Terminal no.	Connection
19	Contact 1
20	Contact 2
21	Contact 1
22	Contact 2
23	Contact 1
24	Contact 2
25	Contact 1
26	Contact 2
27	Contact 1
28	Contact 2
29	Contact 1
30	Contact 2
31	Supply input +24 Vdc / LED device 1
32	Supply input +24 Vdc / LED device 2
33	Supply input +24 Vdc / LED device 3
34	Supply input 0 V / LED



### Switch with integrated control devices and M23 connector, 19-pole

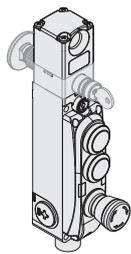

NG 2D••••1C-K603			
	Description	Colour	Terminals
Device 1	illuminated button, spring-return 1NO	white	17 18 6 19
Device 2	illuminated button, spring-return 1NO	yellow	15 16 6 19
Device 3	emergency button, not illuminated, with rotary release 2NC	red	10 13 11 14

NG 2D••••1D-K603			
	Description	Colour	Terminals
Device 1	illuminated button, spring-return 1NO	white	17 18 6 19
Device 2	button, not illuminated, spring-return 1NO	black	15 6
Device 3	emergency button, not illuminated, with rotary release 2NC	red	10 13 11 14

NG 2D••••2V-K603			
	Description	Colour	Terminals
Device 1	illuminated button, spring-return 1NO	white	17 18 6 19
Device 2	illuminated button, spring-return 1NO	blue	15 16 6 19
Device 3	emergency button, not illuminated, with rotary release 2NC	red	10 13 11 14

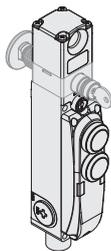

NG 2D••••1E-K602			
	Description	Colour	Terminals
Device 1	illuminated button, spring-return 1NO	white	17 18 6 19
Device 2	button, not illuminated, spring-return 1NO	black	15 6

NG 2D••••1F-K602			
	Description	Colour	Terminals
Device 1	illuminated button, spring-return 1NO	green	17 18 6 19
Device 2	illuminated button, spring-return 1NO	red	15 16 6 19

NG 2D••••7F-K602			
	Description	Colour	Terminals
Device 1	illuminated button, spring-return 1NO	white	17 18 6 19
Device 2	illuminated button, spring-return 1NO	blue	15 16 6 19

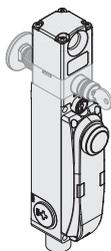

NG 2D••••1G-K601			
	Description	Colour	Terminals
Device 1	illuminated button, spring-return 1NO	green	17 18 6 19

NG 2D••••1H-K601			
	Description	Colour	Terminals
Device 1	illuminated button, spring-return 1NO	white	17 18 6 19

NG 2D••••3G-K601			
	Description	Colour	Terminals
Device 1	illuminated button, spring-return 1NO	blue	17 18 6 19

### Internal connections (version with integrated control devices)

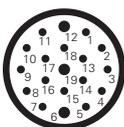

M23 connector, 19-pole	Connection
19	A2 Supply input 0 V
19	B2 0 V auxiliary supply output
1	I4 Solenoid activation input for single channel mode
8	O3 Signalling output, actuator inserted (c)
9	O4 Signalling output, actuator inserted and locked (b) (c)
7	I3 Actuator programming input / reset
/	IE1 Solenoid activation input for double channel mode (d)
/	IE2 Solenoid activation input for double channel mode (d)
6	A1 Supply input +24 Vdc
6	B1 Auxiliary supply output +24 Vdc, 1.5 A max.
2	IS1 Safety input
3	IS2 Safety input
12	I5 EDM input (a)
4	OS1 Safety output
5	OS2 Safety output

Important: terminals 7, 17, 18, of the internal terminal strip must not be used.

(a) Available in NG 2D••••5••• version only.

(b) For NG 2D••••6•••: the output signals the fault condition of the device.

(c) For NG 2D••••7••• articles: the signalling outputs O3 and O4 have negative operating logic (low active signal).

(d) Input not connected.

17	Contact 1	Device 1	
6	Contact 2		
/	Contact 1	Device 2	
15	Contact 2		
6	Contact 1	Device 3	
/	Contact 2		
10	Contact 1		
11	Contact 2		
13	Contact 1		
14	Contact 2		
18	Supply input +24 Vdc / LED device 1		
16	Supply input +24 Vdc / LED device 2		
/	Supply input +24 Vdc / LED device 3		
19	Supply input 0 V / LED		

NG 2D••••1C-K603  
NG 2D••••1D-K603  
NG 2D••••2V-K603

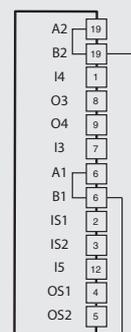

NG 2D••~•1E-K602  
NG 2D••~•1F-K602  
NG 2D••~•7F-K602

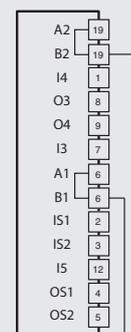

NG 2D••~•1G-K601  
NG 2D••~•1H-K601  
NG 2D••~•3G-K601

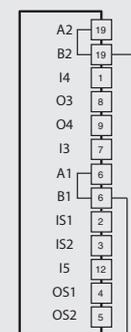

Female connectors See page 321

## Dimensional drawings

NG 2D switch with integrated control devices

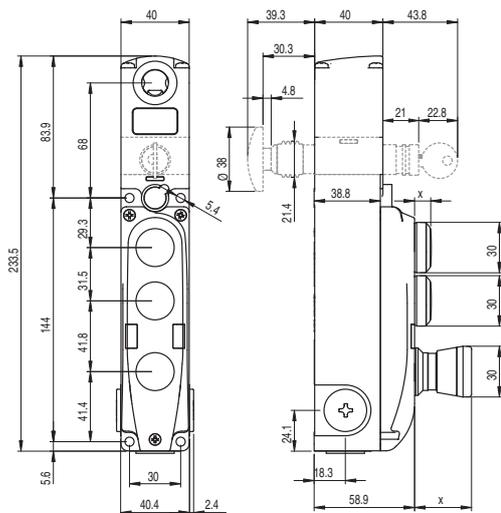

All values in the drawings are in mm

## Available integrated devices

	Description	Colours	Article	Combinable with contacts	Installation height (x) mm
	Illuminated button, spring-return	○ White ● Red ● Green ● Yellow ● Blue	VN NG-AC26005 VN NG-AC26001 VN NG-AC26003 VN NG-AC26002 VN NG-AC26004	1NO 2NO 1NO+1NC	10
	Button, not illuminated, spring-return	● Black	VN NG-AC26007	1NO 2NO 1NO+1NC	10
	Indicator light	○ White ● Red ● Green	VN NG-AC26064 VN NG-AC26060 VN NG-AC26062	/	9.7
	Emergency button acc. to EN ISO 13850			2NC	33.4
	Rotary release Push-pull release	● Red ● Red	VN NG-AC26052 VN NG-AC26055		
	Emergency release button, illuminated, acc. to EN ISO 13850			2NC	33.4
	Rotary release Push-pull release	● Red ● Red	VN NG-AC26051 VN NG-AC26054		
	Illuminated selector switch with handle, with transparent lens for LED	● Black ● Black	VN NG-AC26033 VN NG-AC26034	1NO 2NO 1NO+1NC	23.8
	Key selector switch, 2 positions	● Black ● Black	VN NG-AC26040 VN NG-AC26043	1NO 2NO 1NO+1NC	without key 21~ with key 46~
	Closing cap	● Black	VN NG-AC26090	/	4
	Fixing key	● Black	VN NG-AC26080	/	/

Legend: Maintained Spring-return Key extraction position

Other devices and contacts on request.

Please contact our technical office for the complete list of available products.

## Technical data of the integrated control devices

## General data

Protection degree:	IP65 acc. to EN 60529	
Mechanical endurance:		
Spring-return button:	1 million operating cycles	
Emergency stop button:	50,000 operating cycles	
Selector switch:	300,000 operating cycles	
Key selector switch:	50,000 operating cycles	
Safety parameter B <sub>10D</sub> :	100,000 (emergency stop button)	

## Actuating force

Spring-return button:	4 N min	100 N max.
Emergency stop button:	20 N min	100 N max.
Selector switch:	0.1 Nm min	1.5 Nm max.
Key selector switch:	0.1 Nm min	1.3 Nm max.

## Contact blocks of the control devices

Material of the contacts:	silver contacts
Contact type:	Self-cleaning contacts with double interruption

## Electrical data:

Thermal current I <sub>th</sub> :	1 A
Rated insulation voltage U <sub>i</sub> :	32 Vac/dc
Rated impulse withstand voltage U <sub>imp</sub> :	1.5 kV
LED supply voltage:	24 Vdc ± 15%
LED supply current:	10 mA per LED

## Utilization category of the contact block:

Direct current: DC13
U <sub>e</sub> (V) 24
I <sub>e</sub> (A) 0.55

## In compliance with standards:

IEC 60947-5-1, IEC 60947-5-5, EN ISO 13850

## ⚠ Installation for safety applications:

Always connect the safety circuit to the **NC contacts** (normally closed contacts) as stated in standard EN 60947-5-1.



## Extensions for release button

Article	Description	Drawing
VN NG-LP30	Metal extension for release button. For max. wall thickness of 30 mm	
VN NG-LP40	Metal extension for release button. For max. wall thickness of 40 mm	
VN NG-LP50	Metal extension for release button. For max. wall thickness of 50 mm	
VN NG-LP60	Metal extension for release button. For max. wall thickness of 60 mm	
VN NG-ERB	Red metal release button	

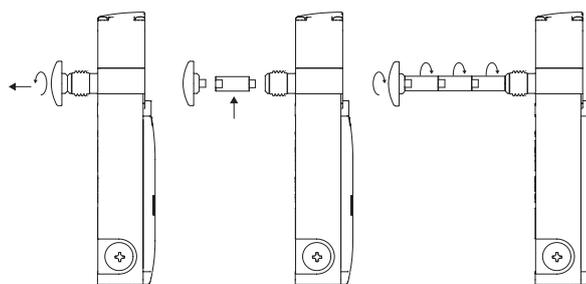

- Metal extensions can be combined with one another to achieve the desired length.
- Do not exceed an overall length of 500 mm between the release button and the switch.
- Use medium-strength thread locker to secure the extensions.

## Adhesive labels for escape release button



Polycarbonate yellow adhesive, rectangular, 300x32 mm, red inscription. It has to be fixed on the internal part of the jamb and helps finding the escape release button.

Article	Description
VF AP-A1AGR01	PREMERE PER USCIRE
VF AP-A1AGR02	PUSH TO EXIT
VF AP-A1AGR04	ZUM ÖFFNEN DRÜCKEN
VF AP-A1AGR05	POUSSER POUR SORTIR
VF AP-A1AGR06	PULSAR PARA SALIR
VF AP-A1AGR07	НАЖАТЬ ДЛЯ ВЫХОДА
VF AP-A1AGR08	NACISNAĆ ABY WYJŚĆ
VF AP-A1AGR09	PRESSIÓNAR PARA SAIR

## Accessories

Article	Description
VF KLB300	Set of two locking keys



Extra copy of the locking keys to be purchased if further keys are needed (standard supply: 2 units).  
The keys of all switches have the same code. Other codes on request.

## Series connection

To simplify series connections of the devices, various M12 connectors are available that allow complete wiring.

This solution significantly reduces installation times while at the same time maintaining the maximum safety levels PL e and SIL 3.

For further information see page 326.

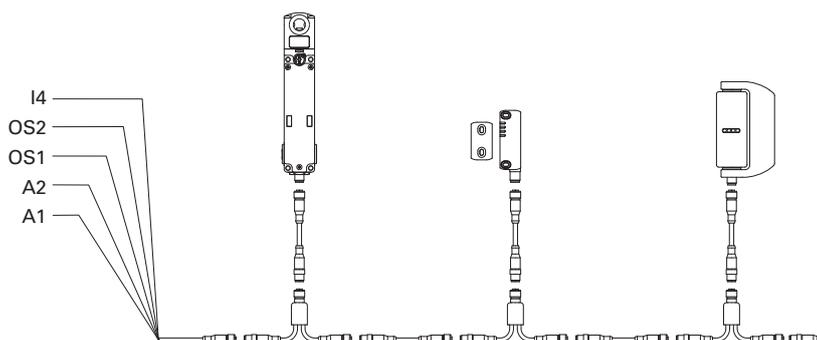

### Description



These switches are used mainly on machines where the hazardous conditions persist even after the machine has been switched off. Mechanical parts such as pulleys, saw blades, etc., could continue to move after the machine is switched off or could still be hot or under pressure. Thus, the switches can also be used if individual guards are only to be opened under certain conditions. Versions with mode 1 and 3 (safety outputs active when guard closed and locked) are interlocks with guard locking acc. to ISO 14119; the product is labelled with the symbol shown.



### Maximum safety with a single device

**PL e + SIL 3** The NS series switches are constructed with redundant electronics. As a result, the maximum PL e and SIL 3 safety levels can still be achieved through the use of a single device on a guard. This avoids expensive wiring in the field and allows faster installation. Inside the control cabinet, the two electronic safety outputs must be connected to a safety module with OSSD inputs or to a safety PLC.

### Series connection of several switches

**PL e + SIL 3** One of the most important features of the NS series is the possibility of connecting up to 32 sensors in series, while still maintaining the maximum safety levels PL e laid down in EN 13849-1 and SIL 3 acc. to EN 62061.

This connection type is permissible in safety systems which have a safety module at the end of the chain that monitors the outputs of the last NS switch.

The fact that the PL e safety level can be maintained even with 32 sensors connected in series demonstrates the extremely secure structure of each single device.

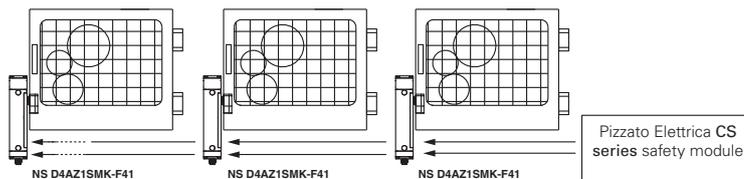

### Series connection with other devices

**PL e + SIL 3** The NS series features two safety inputs and two safety outputs, which can be connected in series with other Pizzato Elettrica safety devices. This option allows the creation of safety chains containing various devices. For example, stainless steel safety hinges (HX BEE1 series), RFID sensors (ST series) and door lock sensors (NG series) can be connected in series while still maintaining the maximum PL e and SIL 3 safety levels.

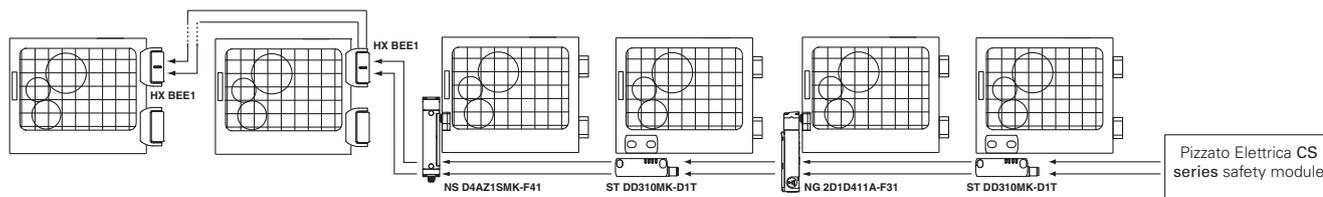

### RFID actuators with high coding level



The NS series is provided with an electronic system based on RFID technology to detect the actuator. This allows to provide each actuator with different coding and makes it impossible to tamper with a device by using another actuator of the same series. Millions of different coding combinations are possible for the actuators. They are therefore classified as high level coded actuators, according to EN ISO 14119.

The NS series is provided with an electronic system based on RFID technology to detect the actuator. This allows to provide each actuator with different coding and makes it impossible to tamper with a device by using another actuator of the same series. Millions of different coding combinations are possible for the actuators. They are therefore classified as high level coded actuators, according to EN ISO 14119.

### Holding force of the locked actuator

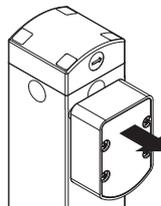

**2100 N** The strong interlocking system guarantees a maximum actuator holding force of  $F_{1max} = 2100 \text{ N}$ .

### Dustproof

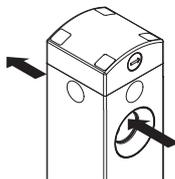

The switch is provided with a through hole for inserting the actuator. Thanks to this unique feature, any dust that enters the actuator hole can always come out on the opposite side instead of remaining inside. Moreover, the lock pin is provided with a diaphragm seal, making the system suitable for critical environments with a high level of dust.

### Centring

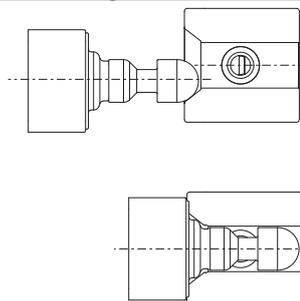

The switch is provided with a wide centring inlet for the actuator pin. This solution makes it easier to align the actuator and the opening hole on the head during installation. Moreover, this solution drastically reduces the probability of a collision between the switch and the actuator, making it possible to install the device even on inaccurately closing guards.

### Head and release devices with variable orientation, not detachable

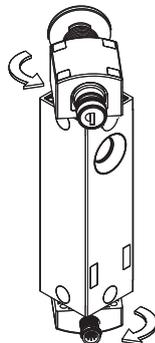

The upper part of the switch, which contains the release devices, can be rotated and is permanently connected to the lower part, which contains the outputs for the electrical connection. After loosening the fastening screws, the individual modules can be rotated in 90° steps. As a result, a single device can be used to realise various configurations without the installation technician needing to concern himself with the correct assembly of various parts.

The fastening screws are provided with protection caps to prevent dirt build-up and thereby simplify cleaning.

### Modularity

The innovative design of the auxiliary releases makes possible a wide range of combinations of auxiliary releases with lock, escape release buttons or screwdriver releases with front and rear mounting.

The electrical connection is also highly flexible: outputs are available with cables as well as with connectors, which can be oriented axially or laterally.



### Six LEDs for immediate diagnosis



As the LEDs have been designed for quick immediate diagnosis, the status of each input and output is highlighted by one specific LED. This makes it possible to quickly identify the interruption points in the safety chain, which device is released, which guard is opened and any errors inside the device. All of this at a glance, without needing to decode complex flashing sequences.

### Holding force of the unlocked actuator

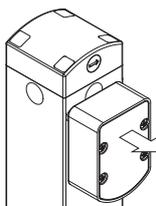

The inside of each switch features a device which holds the actuator in its closed position. Ideal for all those applications where several guards are unlocked simultaneously, but only one is actually opened. The device keeps all the unlocked guards in their position with a retaining force of approx. 20 N, stopping any vibrations or gusts of wind from opening them.

### Function for protecting against recoil forces

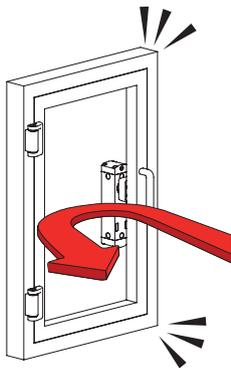

If a guard is closed too quickly or with so much force that the recoil would cause it to open again, a special function in the NS switch prevents locking. This function prevents the immediate locking of the guard if the lock signal is applied. This protects the switch against recoil forces that occur during instantaneous locking, thus avoiding possible damage to the device.

### Key release device and escape release button

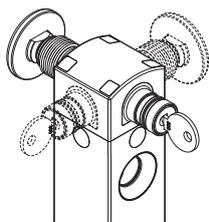

The key release device (auxiliary release) is used to permit unlocking of the actuator only by personnel in possession of the key. The device also functions with no power supply and, once actuated, prevents the guard from being locked.

The escape release button allows actuator release and immediate opening of the guard. Generally used in machines

within which an operator could inadvertently become trapped, it faces towards the machine interior, to allow the operator to exit even in the event of a power failure. The button has two stable states and can be freely extended in length with suitable extensions (see accessories).

Both devices can be positioned on the four sides of the switch. As a result, it can be installed both towards the interior and towards the exterior of the machine.

### Three safety output actuation modes

**MODE 1**  
**MODE 2**  
**MODE 3**

The device is available with 3 different actuation modes for safety outputs:

- mode 1: safety outputs active with inserted and locked actuator, for machines with inertia;
- mode 2: safety outputs active with inserted actuator, for machines without inertia;
- mode 3: a first safety output active with actuator inserted and locked and a second safety output active with actuator inserted, for special applications.

### Protection against tampering

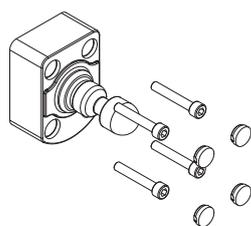

Each actuator of the NS series is supplied with four protection caps. Not only do the caps prevent dirt from accumulating and simplify cleaning, they also block access to the fastening screws of the actuator. As a result, standard screws can be used instead of tamper-proof screws.

### Jointed actuator for inaccurately closing guards

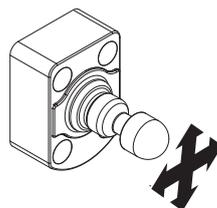

All NS series actuators are articulated, thereby allowing the actuator pin to be safely guided into the switch through the centring hole. As a result, the actuator and switch do not need to be precisely aligned during installation. In addition, the device can thereby be used on guards with a minimum actuation radius of 150 mm without the actuation pin needing to be angled.

### Front and side mounting

Integrated in the housing of the NS series is a hole for inserting the actuator pin. Fixing holes are also provided in the robust body for front and side mounting.

This makes it easier to mount the switch during lateral installation: the switch is directly mounted without needing to rotate the module that

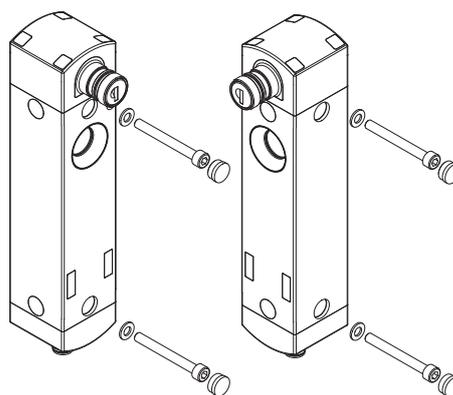

contains the hole for inserting the actuator pin. The fixing holes can be sealed with the protection caps provided for this purpose. Dirt deposits and tampering attempts are thereby prevented.

### High protection degree

**IP69K**  
**IP67**

These devices are designed to be used in the toughest environmental conditions and they pass the IP67 immersion test acc. to EN 60529. They can therefore be used in all environments where maximum protection degree of the housing is required. Due to their

special design, these devices are suitable for use in equipment subjected to cleaning with high pressure hot water jets. These devices meet the IP69K test requirements according to ISO 20653 (water jets with 100 bar and 80°C).

### External device monitoring

**EDM**

On request, the switch can be supplied with EDM function (External Device Monitoring). In this case, the switch itself checks the proper function of the devices connected to the safety outputs. These devices (usually relays or safety contactors) must send a feedback signal to the EDM input, which checks that the received signal is consistent with the state of the safety outputs.

## Selection diagram

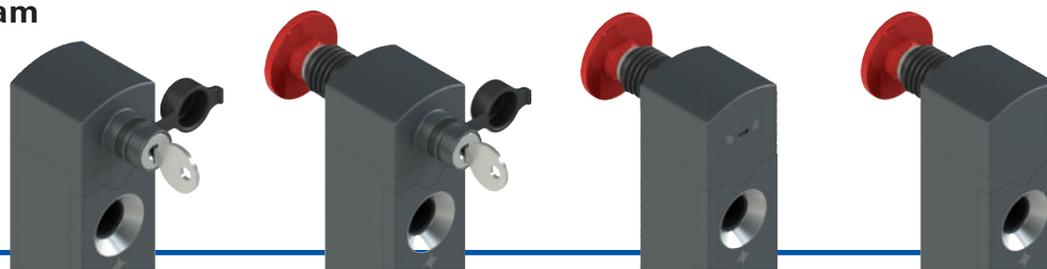
**D•ST**

Locked actuator with **de-energised** solenoid  
key release at front

**D•SE**

Locked actuator with **de-energised** solenoid  
key release at front and escape  
release button at back

**D•CE**

Locked actuator with **de-energised** solenoid  
release by means of  
screwdriver at front and escape  
release button at back

**E•TE**

Locked actuator with **energised**  
solenoid  
Without release at front and  
escape release button at back

**D•AZ**

Locked actuator with **de-energised** solenoid  
release by means of  
screwdriver at front

**E•ZZ**

Locked actuator with **energised**  
solenoid

## RELEASE AND OPERATING PRINCIPLE



## ACTUATORS

**VN NS-F40**

Low level coded actuator

**VN NS-F41**

High level coded actuator

## CONNECTIONS

M12 connector,  
at bottom

<b>SMK</b>	12-pole
<b>SPK</b>	8-pole for stand-alone connection
<b>SQK</b>	8-pole, for series connection with Y connectors

M12 connector,  
lateral, orientable

<b>DMK</b>	12-pole
<b>DPK</b>	8-pole for stand-alone connection
<b>DQK</b>	8-pole, for series connection with Y connectors

Cable, length: 0.2 m, with  
M12 connector, at bottom

<b>SM0.2</b>	12-pole
<b>SP0.2</b>	8-pole for stand-alone connection
<b>SQ0.2</b>	8-pole, for series connection with Y connectors

Cable, length: 0.2 m, with  
M12 connector, lateral,  
orientable

<b>DM0.2</b>	12-pole
<b>DP0.2</b>	8-pole for stand-alone connection
<b>DQ0.2</b>	8-pole, for series connection with Y connectors

With PVC cable  
at bottom

<b>SA2</b>	12-pole, length: 2 m
<b>SB2</b>	8-pole, length: 2 m, for stand-alone connections

With PVC cable, lateral,  
orientable

<b>DA2</b>	12-pole, length: 2 m
<b>DB2</b>	8-pole, length: 2 m, for stand-alone connections

- product options
- sold separately as accessory

**Code structure****Attention!** The feasibility of a code number does not mean the effective availability of a product. Please contact our sales office.

article	options
<b>NS D4AZ1SMK</b>	<b>-F41E36LP30</b>

Operating principle	
<b>D</b>	locked actuator with de-energised solenoid. mode 1: OS safety outputs active with inserted and locked actuator
<b>E</b>	locked actuator with energised solenoid. mode 1: OS safety outputs active with inserted and locked actuator
<b>G</b>	locked actuator with de-energised solenoid. mode 2: OS safety outputs active with inserted actuator
<b>H</b>	locked actuator with energised solenoid. mode 2: OS safety outputs active with inserted actuator
<b>L</b>	locked actuator with de-energised solenoid. mode 3: first safety output OS1 active with inserted and locked actuator, second safety output OS2 active with inserted actuator
<b>M</b>	locked actuator with energised solenoid. mode 3: first safety output OS1 active with inserted and locked actuator, second safety output OS2 active with inserted actuator

Inputs and outputs	
<b>3</b>	2 safety inputs IS1, IS2 2 safety outputs OS1, OS2 1 signalling output O3: actuator inserted 1 signalling output O4: actuator locked 2 solenoid activation inputs IE1, IE2 1 reset input I3 Note: Supplied only together with actuator
<b>4</b>	2 safety inputs IS1, IS2 2 safety outputs OS1, OS2 1 signalling output O3: actuator inserted 1 signalling output O4: actuator locked 2 solenoid activation inputs IE1, IE2 1 programming / reset input I3
<b>5</b>	2 safety inputs IS1, IS2 2 safety outputs OS1, OS2 1 signalling output O3: actuator inserted 1 signalling output O4: actuator locked 2 solenoid activation inputs IE1, IE2 1 programming / reset input I3 1 feedback input EDM I5 Note: Not available with mode 3

Auxiliary release at front and back	
<b>AZ</b>	release by means of screwdriver at front only available for operating principle D, G and L
<b>ST</b>	key release at front only available for operating principle D, G and L
<b>SE</b>	key release at front and escape release button at back only available for operating principle D, G and L
<b>CE</b>	release by means of screwdriver at front and escape release button at back only available for operating principle D, G and L
<b>ZZ</b>	without release only available for operating principle E, H and M
<b>TE</b>	Without release at front and escape release button at back only available for operating principle E, H and M

Release button length	
	for max. 15 mm wall thickness (standard)
<b>LP30</b>	for max. 30 mm wall thickness
<b>LP40</b>	for max. 40 mm wall thickness
<b>LP50</b>	for max. 50 mm wall thickness

Actuator extraction force	
	actuator extraction force 20 N (standard)
<b>E36</b>	actuator freely removable
<b>E37</b>	actuator extraction force 40 N

Actuator	
<b>F40</b>	low level coded actuator VN NS-F40 the switch recognises any type F40 actuator
<b>F41</b>	high level coded actuator VN NS-F41 the switch recognises one single type F41 actuator

Connection type	
<b>K</b>	integrated M12 connector (standard)
<b>0.2</b>	cable, length: 0.2 m, with M12 connector
<b>2</b>	cable, length: 2 m (standard)
...	.....
<b>10</b>	cable, length: 10 m

Cable or connector type	
<b>A</b>	PVC cable 12x0.14 mm <sup>2</sup> (standard)
<b>B</b>	PVC cable 8x0.34 mm <sup>2</sup> for stand-alone connection Note: without inputs IS1, IS2, I5 and without output O4
<b>E</b>	PUR cable, halogen-free, 8x0.34 mm <sup>2</sup> for stand-alone connection Note: without inputs IS1, IS2, I5 and without output O4
<b>M</b>	M12 connector, 12-pole (standard)
<b>P</b>	M12 connector, 8-pole, for stand-alone connections Note: without inputs IS1, IS2, I5 and without output O4
<b>Q</b>	M12 connector, 8-pole, for series connection with Y connectors Note: without inputs IE2, I3, I5 and without output O3

Output direction, connections	
<b>D</b>	cable or connector, lateral
<b>S</b>	cable or connector, at bottom

**Code structure for actuator****VN NS-F40**

Actuator	
<b>F40</b>	low level coded actuator the switch recognises any type F40 actuator
<b>F41</b>	high level coded actuator the switch recognises one single type F41 actuator



### Main features

- Actuation without contact, using RFID technology
- Digitally coded actuator
- SIL 3 and PL e also with series connection of up to 32 devices
- Max. actuator holding force: 2100 N
- SIL 3 and PL e with a single device
- Protection degrees IP67 and IP69K
- 6 signalling LEDs

### Quality marks:



EC type examination certificate: M6A171075157020  
 UL approval: E131787  
 TÜV SÜD approval: Z10 075157 0025  
 EAC approval: RU C-IT.YT03.B.00035/19

### In compliance with standards:

EN ISO 14119, EN 60947-5-3, EN 60947-1,  
 IEC 60204-1, EN 60204-1, EN ISO 12100,  
 IEC 60529, EN 60529, EN 61000-6-2,  
 EN 61000-6-3, BG-GS-ET-19, IEC 61508-1,  
 IEC 61508-2, IEC 61508-3, IEC 61508-4,  
 SN 29500, EN ISO 13849-1, EN ISO 13849-2,  
 EN 62061, EN 61326-1, EN 61326-3-1,  
 EN 61326-3-2, EN 50581, ETSI 301 489-1,  
 ETSI 301 489-3, ETSI 300 330-2, UL 508,  
 CSA 22.2 No.14

### Compliance with the requirements of:

Machinery Directive 2006/42/EC, EMC Directive  
 2014/30/EC, RED Directive 2014/53/EU,  
 RoHS directive 2011/65/EU, FCC Part 15.

### Features approved by UL

Electrical Ratings: 24 Vdc, 0,25 A.  
 Input supplied by 24 Vdc, Class 2 source or limited voltage  
 limited energy  
 Environmental Ratings: Types 1, 4X, 12, 13.

### Features approved by TÜV SÜD

Protection degree: IP67, IP69K  
 Ambient temperature: -20°C...+50°C  
 PL, category: Cat 2 / 4, PL d / e  
 SIL: SIL 2/3, SIL CL 2/3  
 In compliance with standards: EN ISO 14119:2013,  
 EN 60947-5-3:2013, EN 61508-1:2010 (SIL 3),  
 EN 61508-2:2010 (SIL 3), EN 61508-3:2010 (SIL 3),  
 EN 61508-4:2010 (SIL 3), EN 62061:2005/A2:2015  
 (SIL CL 3), EN ISO 13849-1:2015 (Cat. 4, PL e).  
 Complies with machinery directive 2006/42/EC  
**Please contact our technical department for the list of approved  
 products.**

### Technical data

Housing made of glass fibre reinforced technopolymer, self-extinguishing and shock-proof  
 Versions with 12x0.14mm<sup>2</sup> or 8x0.34mm<sup>2</sup> integrated cable, length 2 m, other lengths  
 from 0.5 to 10 m on request  
 Versions with integrated M12 stainless steel connector  
 Versions with 0.2 m cable and M12 connector, other lengths from 0.1 ... 3 m on request  
 Protection degree: IP67 acc. to EN 60529  
 IP69K acc. to ISO 20653 (Protect the cables  
 from direct high-pressure and high-temperature jets)

### General data

Safety parameters	SIL	PL	Cat.	DC	PFH <sub>0</sub>	MTTF <sub>0</sub>
Monitoring function: actuator locked - Mode 1	3	e	4	High	1.23E-09	2657
Monitoring function: actuator present - Mode 2	3	e	4	High	1.22E-09	1840
Monitoring function: actuator locked - Mode 3	2	d	2	High	1.50E-09	2627
Monitoring function: actuator present - Mode 3	2	d	2	High	1.49E-09	3987
Dual-channel control for locking function of the actuator	3	e	4	High	2.04E-10	2254
Single-channel control for locking function of the actuator	2	d	2	High	2.04E-10	2254

Interlock, no contact, coded, with guard locking: type 4 acc. to EN ISO 14119  
 Level of coding acc. to EN ISO 14119: low with F40 actuator  
 High with F41 actuator

Mission time: 20 years  
 Ambient temperature: -20°C ... +50°C  
 Max. actuation frequency: 600 operating cycles/hour  
 with actuator lock and release: 1 million operating cycles  
 Mechanical endurance: 0.5 m/s  
 Max. actuation speed: 1 mm/s  
 Min. actuation speed: 2100 N acc. to EN ISO 14119  
 Maximum force before breakage  $F_{1max}$ : 1615 N acc. to EN ISO 14119  
 Max. holding force  $F_{Zh}$ : 4 mm  
 Maximum clearance of locked actuator: ~ 20 N  
 Released actuator extraction force:

### Power supply electrical data

Rated operating voltage  $U_e$  SELV: 24 Vdc  $\pm$  10%  
 Operating current at  $U_e$  voltage: 40 mA min.; 0.4 A max. with activated solenoid;  
 1.2 A with activated solenoid and all outputs at  
 maximum power

Rated insulation voltage  $U_i$ : 32 Vdc  
 Rated impulse withstand voltage  $U_{imp}$ : 1.5 kV  
 External protection fuse: type gG fuse 2 A or equivalent device  
 III  
 Overvoltage category: 1 million operating cycles  
 Electrical endurance: 100% ED (continuous operation)  
 Solenoid duty cycle: 9 W max.  
 Solenoid consumption: 3 acc. to EN 60947-1  
 Pollution degree:

### Electrical data of inputs IS1/IS2/I3/IE1/IE2/I5/EDM

Rated operating voltage  $U_{e1}$ : 24 Vdc  
 Rated current consumption  $I_{e1}$ : 5 mA

### Electrical data of OS1/OS2 safety outputs

Rated operating voltage  $U_{e2}$ : 24 Vdc  
 Output type: PNP type OSSD  
 Maximum current per output  $I_{e2}$ : 0.25 A  
 Minimum current per output  $I_{m2}$ : 0.5 mA  
 Thermal current  $I_{th2}$ : 0.25 A  
 Utilization category: DC13;  $U_{e2}$ =24 Vdc,  $I_{e2}$ =0.25 A  
 Short circuit detection: Yes  
 Overcurrent protection: Yes  
 Internal self-resettable protection fuse: 1.1 A  
 Duration of the deactivation impulses at the safety outputs: < 300  $\mu$ s  
 Permissible maximum capacitance between outputs: < 200 nF  
 Permissible maximum capacitance between output and ground: < 200 nF  
 Activation time of safety outputs OS1 and OS2  
 after deactivation of safety inputs IS1, IS2: typically 7 ms, max. 15 ms  
 Activation time upon unlocking the actuator: typically 7 ms, max. 12 ms  
 Activation time upon removal of the actuator: typically 120 ms, max. 200 ms  
 Maximum delay for EDM status change: 500 ms

### Electrical data of O3/O4 signalling outputs

Rated operating voltage  $U_{e3}$ : 24 Vdc  
 Output type: PNP  
 Maximum current per output  $I_{e3}$ : 0.1 A  
 Utilization category: DC13;  $U_{e3}$ =24 Vdc,  $I_{e3}$ =0.1 A  
 Short circuit detection: No  
 Overcurrent protection: Yes  
 Internal self-resettable protection fuse: 1.1 A

### RFID sensor data

Assured operating distance  $S_{ao}$ : 2 mm  
 Assured release distance  $S_{ar}$ : 6 mm (actuator not locked)  
 10 mm (actuator locked)  
 Rated operating distance  $S_n$ : 3 mm  
 Repeat accuracy:  $\leq$  10 %  $s_n$   
 Differential travel:  $\leq$  20 %  $s_n$   
 RFID transponder frequency: 125 kHz  
 Max. switching frequency: 1 Hz



## Actuation mode of the OS1 and OS2 safety outputs

Mode 1	Mode 2	Mode 3
Safety outputs OS1 and OS2 are active when the actuator is inserted and locked.	Safety outputs OS1 and OS2 are active when the actuator is inserted.	Safety output OS1 is active when the actuator is inserted and locked and IS1 is active. Safety output OS2 is active when the actuator is inserted and IS2 is active.
In case of machines with or without inertia of the dangerous elements. Safety category of the safety outputs: PL e, SIL 3.	In case of machines without inertia of the dangerous elements. Safety category of the safety outputs: PL e, SIL 3.	In case of machines with or without inertia of the dangerous elements. Safety category of the safety outputs: PL d, SIL 2.

## Selection table for switches with high level coded actuators

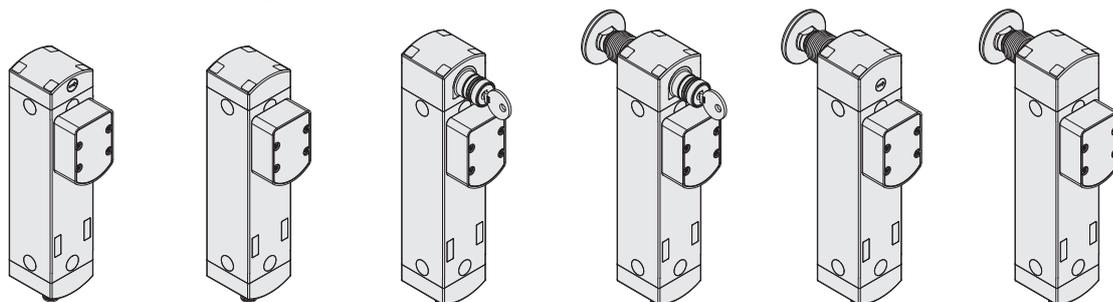

Operating principle	Locked actuator with de-energised solenoid. With screwdriver release	Locked actuator with energised solenoid	Locked actuator with de-energised solenoid. With key release	Locked actuator with de-energised solenoid. With key release and escape release button	Locked actuator with de-energised solenoid. With screwdriver release and escape release button	Locked actuator with energised solenoid. With escape release button
Mode 1	NS D4AZ1SMK-F41	NS E4ZZ1SMK-F41	NS D4ST1SMK-F41	NS D4SE1SMK-F41	NS D4CE1SMK-F41	NS E4TE1SMK-F41
Mode 2	NS G4AZ1SMK-F41	NS H4ZZ1SMK-F41	NS G4ST1SMK-F41	NS G4SE1SMK-F41	NS G4CE1SMK-F41	NS H4TE1SMK-F41
Mode 3	NS L4AZ1SMK-F41	NS M4ZZ1SMK-F41	NS L4ST1SMK-F41	NS L4SE1SMK-F41	NS L4CE1SMK-F41	NS M4TE1SMK-F41

## Selection table for switches

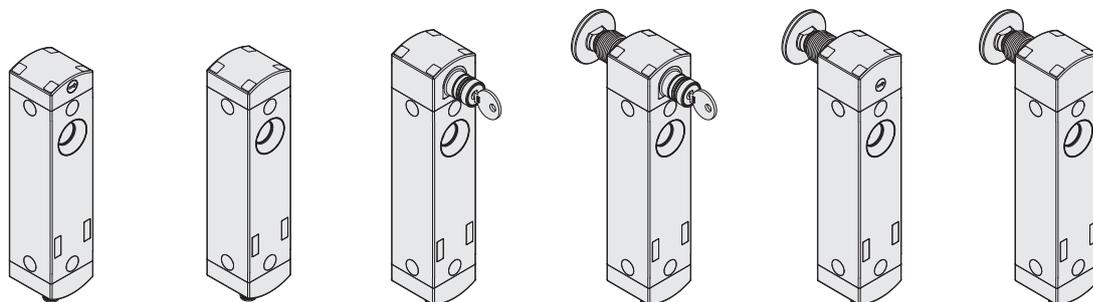

Operating principle	Locked actuator with de-energised solenoid. With screwdriver release	Locked actuator with energised solenoid	Locked actuator with de-energised solenoid. With key release	Locked actuator with de-energised solenoid. With key release and escape release button	Locked actuator with de-energised solenoid. With screwdriver release and escape release button	Locked actuator with energised solenoid. With escape release button
Mode 1	NS D4AZ1SMK	NS E4ZZ1SMK	NS D4ST1SMK	NS D4SE1SMK	NS D4CE1SMK	NS E4TE1SMK
Mode 2	NS G4AZ1SMK	NS H4ZZ1SMK	NS G4ST1SMK	NS G4SE1SMK	NS G4CE1SMK	NS H4TE1SMK
Mode 3	NS L4AZ1SMK	NS M4ZZ1SMK	NS L4ST1SMK	NS L4SE1SMK	NS L4CE1SMK	NS M4TE1SMK

To order a product with lateral connection replace character **S** with character **D** in the order codes shown above. Example: NS D4AZ1SMK → NS D4AZ1DMK

To order a product with EDM input replace number **4** with number **5** in the codes shown above. Example: NS D4AZ1SMK → NS D5AZ1SMK

Legend: interlock with lock monitoring acc. to EN ISO 14119

## Selection table for actuators

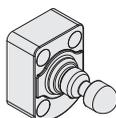

Level of coding acc. to EN ISO 14119	Article
low	VN NS-F40
high	VN NS-F41

The use of RFID technology in NS series devices makes them suitable for several applications. Pizzato Elettrica offers two different versions of actuators, in order to best suit customers' specific needs.

Type F40 actuators are all encoded with the same code. This implies that a device associated with an actuator type F40 can be activated by other actuators type F40.

Type F41 actuators are always encoded with different codes. This implies that a device associated with an actuator type F41 can be activated only by a specific actuator. Another F41 type actuator will not be recognised by the device until a new association procedure is carried out (reprogramming). After reprogramming, the old actuator F41 will no longer be recognized.

Reprogramming of the actuator can be performed repeatedly.

## Complete safety system

The use of complete and tested solutions guarantees the electrical compatibility between the NS series switches and the safety modules from Pizzato Elettrica, as well as high reliability. The switches have been tested with the modules listed in the adjacent table.

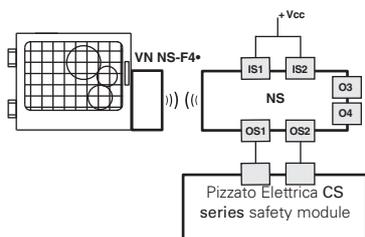

NS series switches can be used as individual devices provided that the safety outputs be evaluated by a Pizzato Elettrica safety module (see table for combinable safety modules).

Switches	Compatible safety modules	Safety module output contacts		
		Instantaneous safety contacts	Delayed safety contacts	Signalling contacts
NS ●●●●1●●●	CS AR-05●●●●	3NO	/	1NC
	CS AR-06●●●●	3NO	/	1NC
	CS AR-08●●●●	2NO	/	/
	CS AT-0●●●●●	2NO	2NO	1NC
	CS AT-1●●●●●	3NO	2NO	/
	CS MP●●●●●●			page 277
CS MF●●●●●●			page 305	

All NS series switches can be connected, provided that compatibility is checked, to safety modules or safety PLCs with OSSD inputs.

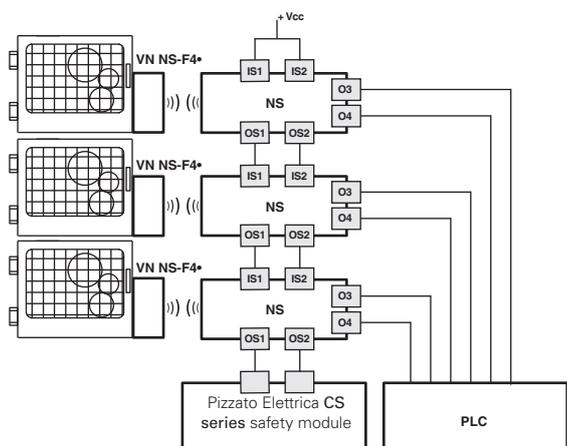

Possibility of series connection of multiple switches for simplifying the wiring of the safety system, whereby only the outputs of the last switch are evaluated by a Pizzato Elettrica safety module (see table with compatible safety modules). Each NS series switch is provided with two signalling outputs which are activated when the guard is closed (O3) or locked (O4). Depending on the specific requirements of the system that has been realised, the signals of the signalling outputs can be evaluated by a PLC.

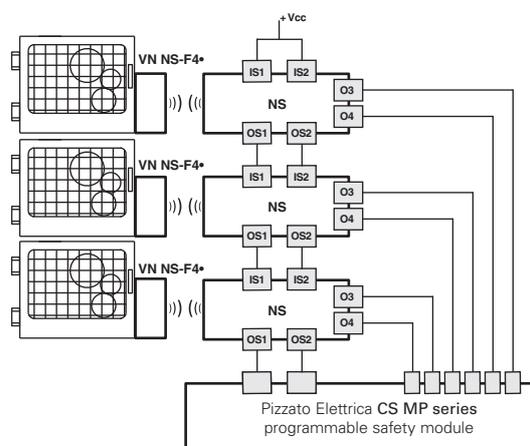

Possibility of series connection of multiple switches for simplifying the wiring of the safety system, whereby only the outputs of the last switch are evaluated by a Pizzato Elettrica safety module of the CS MP series. Both the safety-relevant evaluation and the evaluation of the signalling outputs are performed by the CS MP series.

The examples listed above refer to applications with NS ●●●●1●●●.

## Internal block diagram

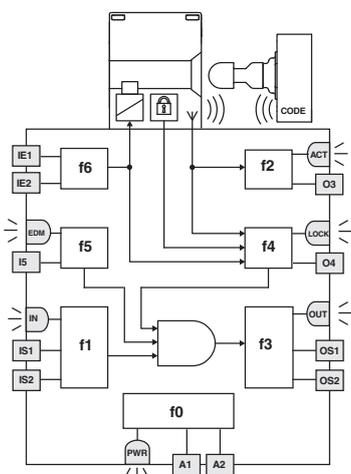

LED	Function
PWR	Power supply / self-diagnosis
IN	status of safety inputs
OUT	status of safety outputs
ACT	actuator state
LOCK	actuator locked
EDM	state of EDM inputs (NS ●5●●1●●●)

The diagram on the side represents the 7 logic functions which interact inside the device.

Function f0 is a basic function and includes the monitoring of the power supply as well as internal, cyclical tests. Function f1 monitors the status of the device inputs, whereas function f2 monitors the presence of the actuator within the detection areas of the switch.

Function f4 checks the actuator lock condition.

Function f3 is intended to activate or deactivate the safety outputs and check for any faults or short circuits in the outputs.

In the EDM versions, the f5 function verifies the consistency of the EDM signal during safety output state changes.

The safety-related function, which combines the sub-functions mentioned above, activates the safety outputs according to the chosen operating mode:

- Both safety outputs OS1/OS2 for switches in mode 1 are activated only if both IS1/IS2 safety inputs are active and the actuator is inserted and locked;
- Both safety outputs OS1/OS2 for switches in mode 2 are activated only if both IS1/IS2 safety inputs are active and the actuator is inserted;
- The safety output OS1 for switches in mode 3 is activated only if the IS1 safety input is active and the actuator is inserted and locked, whereas the safety output OS2 is activated only if the IS2 safety input is active and the actuator is inserted.

The f6 function verifies the coherence of the enable/disable signals of the actuator lock command.

The status of each function is displayed by the corresponding LED (PWR, IN, OUT, ACT, LOCK, EDM), in such a way that the general device status becomes immediately obvious to the operator.





### Actuation sequence in mode 1

The switch is supplied with power (PWR LED on, green), the IS1 and IS2 inputs are enabled (IN LED on, green), the OS1 and OS2 safety outputs are disabled (OUT LED off). The actuator is outside of the actuation zone (LED ACT off).

When the actuator is brought inside the safe actuation area (dark grey area), the switch turns on the ACT LED (green). In this position, the O3 signalling output (door-closed) is activated. The actuator is not locked (LOCK LED off).

The IE1, IE2 inputs can be used to lock the actuator (LOCK LED on, green). The OS1 and OS2 safety outputs are enabled (OUT LED on, green). The O4 signalling output is activated at the same time. The safe actuation area is extended in order to allow greater play for the actuator.

The IE1, IE2 inputs can be used to unlock the actuator (LOCK LED off). The switch disables the OS1 and OS2 safety outputs and turns off the OUT LED. The O4 signalling output is deactivated at the same time. The safe actuation area returns to the initial values.

When the actuator leaves the actuation limit area, the device turns off the ACT LED and the O3 signalling output.

### Actuation sequence in mode 2 and mode 3

In contrast to the above mode 2 description, the safety outputs OS1 and OS2 are activated when the actuator is detected, and deactivated when the actuator is no longer detectable, in mode 3, the OS1 safety output is active with inserted and locked actuator and IS1 active, the OS2 safety output is active with inserted actuator and IS2 active.

### Operating states

PWR LED	IN LED	OUT LED	ACT LED	LOCK LED	EDM LED (a)	Device state	Description
○	○	○	○	○	○	OFF	Device switched off.
●	●	●	●	●	●	POWER ON	Internal tests upon activation.
●	○	○	*	*	●	RUN	Safety inputs of the device not active.
●	●	*	*	*	*	RUN	Activation of safety inputs.
●	⚡	○	*	*	*	RUN	Safety inputs incoherence. Recommended action: check for presence and/or wiring of inputs.
●	*	*	*	⚡	*	RUN	Incoherence of solenoid activation inputs IE1, IE2. Recommended action: check for presence and/or wiring of inputs.
●	*	*	*	⚡	*	RUN	Auxiliary release activated. Deactivate the auxiliary release to lock the actuator
●	*	*	●	*	*	RUN	Actuator in safe area. O3 signalling output active.
●	*	*	●	●	○	RUN	Actuator in safe area and locked; O3 and O4 outputs active.
●	●	●	●	●	○	RUN	<b>Mode 1</b> Activation of safety inputs IS1, IS2. Actuator in safe area and locked. O3, O4, OS1 and OS2 outputs active.
●	●	●	●	*	○	RUN	<b>Mode 2</b> Activation of safety inputs IS1, IS2. Actuator in safe area. O3, OS1 and OS2 outputs active.
●	●	●	●	●	○	RUN	<b>Mode 3</b> Actuator present, guard closed and locked, IS1 enabled, IS2 disabled, OS1 enabled, OS2 disabled
●	●	●	●	○	○	RUN	<b>Mode 3</b> Actuator present, guard closed and not locked, IS1 and IS2 enabled, OS1 disabled, OS2 enabled
⚡	*	*	*	*	*	RUN	Rapid flashing: supply voltage too high. Slow flashing: temperature outside admissible range
●	*	⚡	*	*	*	ERROR	Error on safety outputs. Recommended action: check for any short circuits between the outputs, outputs and ground or outputs and power supply, then restart the device.
●	○	○	⚡	○	○	ERROR	Actuator detection error. Check the physical integrity of the device and, in case of failure, please replace the entire device. If undamaged, realign the actuator with the switch and restart the device.
●	○	○	○	○	○	ERROR	Internal error. Recommended action: restart the device. If the failure persists, replace the device.
●	*	○	*	*	●	RUN	EDM signal active (external relay off) <sup>a</sup>
●	●	●	●	●	○	RUN	EDM signal not active (external relay on) <sup>a</sup>
●	○	○	○	○	⚡	ERROR	Error in the EDM <sup>a</sup> function

Legend:  
 ○ = off  
 ● = on  
 ⚡ = blinking  
 ● = changing colours  
 \* = indifferent  
 (a) Available for NS ●5●1●●● versions only

## External device monitoring (EDM)

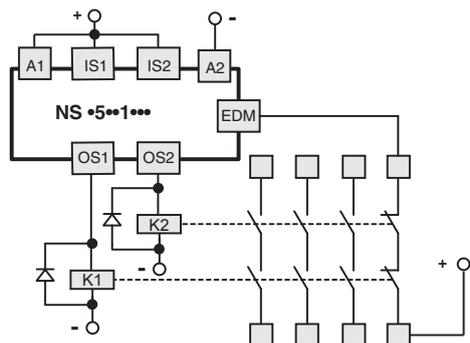

The NS 5...1... version, in addition to maintaining the operating and safety characteristics of the NS series, allows control of **forcibly guided NC contacts of contactors or relays** controlled by the safety outputs of the switch itself. As an alternative to the relays or contactors you can use Pizzato Elettrica expansion modules CS ME-03 (see page 267). This check is carried out via the EDM input (External Device Monitoring as defined in EN 61496-1) of the switch.

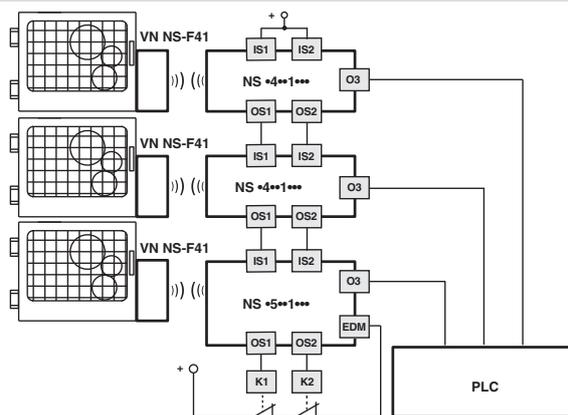

This version, with the IS safety inputs, **can be used at the end of a series of NS switches, up to a maximum number of 32 devices**, while maintaining the maximum PL e safety level and acc. to EN ISO 13849-1 and SIL 3 safety level acc. to EN 62061. This solution allows you to dispense with the safety module connected to the last device in the chain. If present, the EDM function must be used.

## Connection with safety modules

Connections with CS AR-08... safety modules

Input configuration with monitored start  
2 channels / Category 4 / up to SIL 3 / PL e

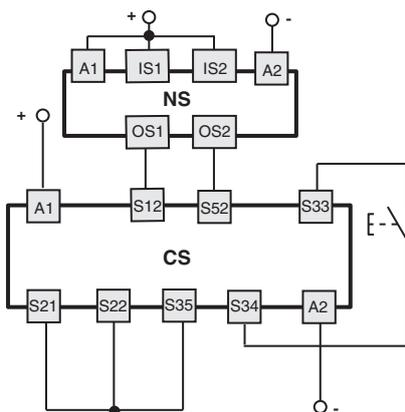

Connections with CS AR-05... / CS AR-06... safety modules

Input configuration with manual start (CS AR-05...)  
or monitored start (CS AR-06...)

2 channels / Category 4 / up to SIL 3 / PL e

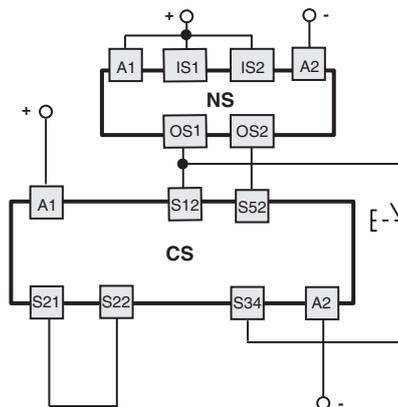

Connections with CS AT-0... / CS AT-1... safety modules

Input configuration with monitored start  
2 channels / Category 4 / up to SIL 3 / PL e

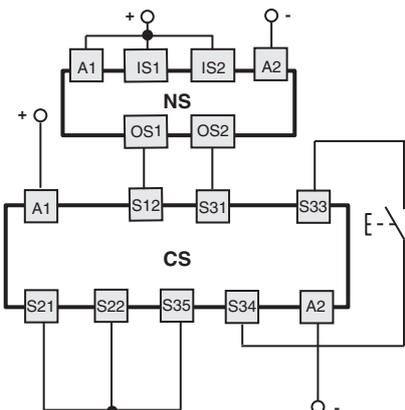

Connections with CS MF..., CS MP... safety modules

The connections vary according to the program of the module  
Category 4 / up to SIL 3 / PL e

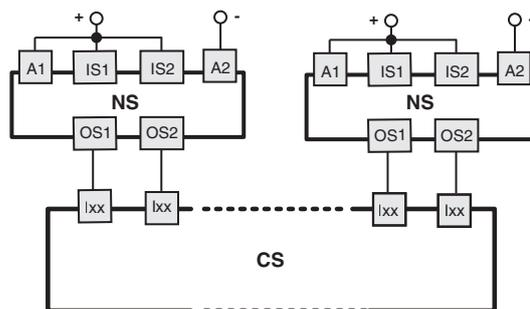

Application example on page 275.



### Series connection of several switches

Monitoring function: actuator locked  
 2 channels / Category 4 / up to SIL 3 / PL e  
 Single-channel control for locking function of the actuator  
 1 channel / Category 2 / up to SIL 2 / PL d

Monitoring function: actuator locked  
 2 channels / Category 4 / up to SIL 3 / PL e  
 Dual-channel control for locking function of the actuator  
 2 channels / Category 4 / up to SIL 3 / PL e

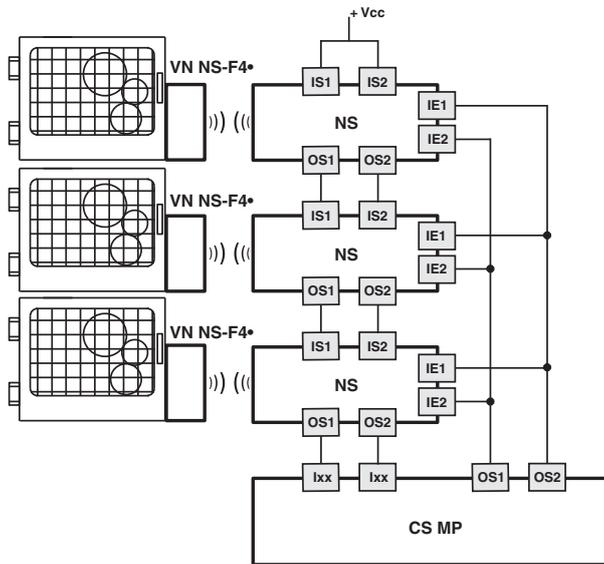
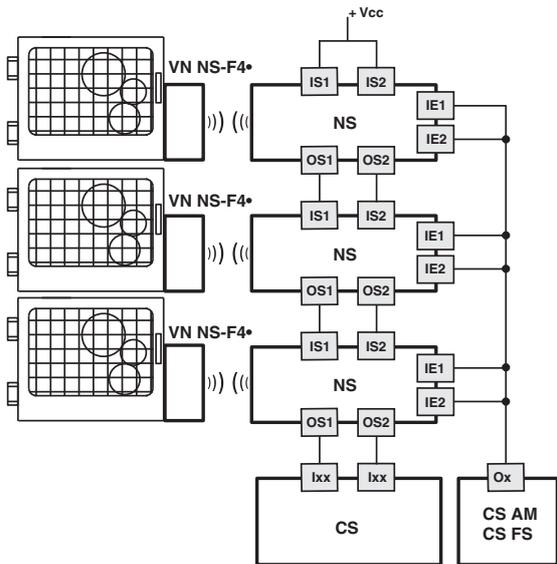

### Internal connections

Versions with connector			Versions with cable		Connection
M12 connector, 12-pole	M12 connector, 8-pole stand-alone connection	M12 connector, 8-pole series connection with "Y" connectors	Cable 12x0.14 mm <sup>2</sup> external Ø 6 mm	Cable 8x0.34 mm <sup>2</sup> external Ø 7 mm	
3	3	3	White	Blue	A2 Supply input 0 V
10	8	8	Purple	Red	IE1 Solenoid activation input
12	5	/	Red-Blue	Purple	IE2 Solenoid activation input
5	2	/	Pink	Black	O3 Signalling output, actuator inserted
9	/	5(b)	Red	/	O4 Signalling output, actuator inserted and locked
8	6	/	Grey	purple-white	I3 Actuator programming input / reset
1	1	1	Brown	Brown	A1 Supply input +24 Vdc
2	/	2	Blue	/	IS1 Safety input
6	/	6	Yellow	/	IS2 Safety input
11	/	/	Grey-Pink	/	I5 EDM input (a)
4	4	4	Green	Red-White	OS1 Safety output
7	7	7	Black	Black-White	OS2 Safety output

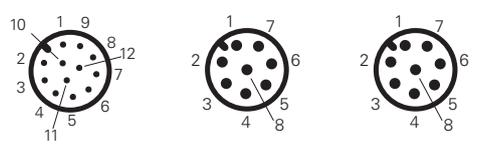

(a) Available for NS •5••1••• version only  
 (b) Available for 8-pole connector, not available for the end of a chain with Y connectors.

Switch  
NS ••AZ1SMK  
NS ••ZZ1SMK

Switch  
NS ••AZ1DMK  
NS ••ZZ1DMK

Switch  
NS ••ST1SMK  
NS ••SE1SMK

NS ••CE1SMK  
NS ••TE1SMK

Switch  
NS ••ST1DMK  
NS ••SE1DMK

NS ••CE1DMK  
NS ••TE1DMK

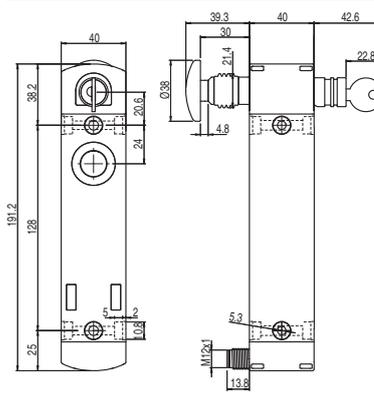
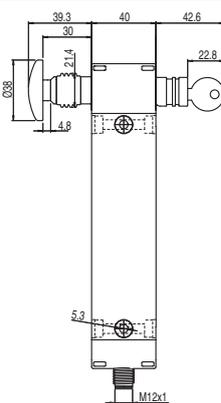
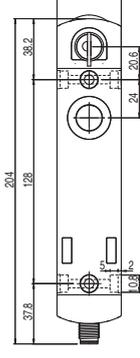
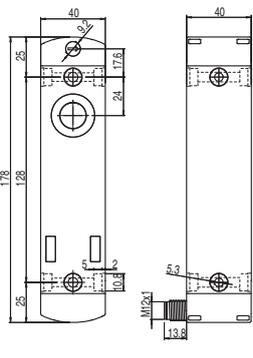
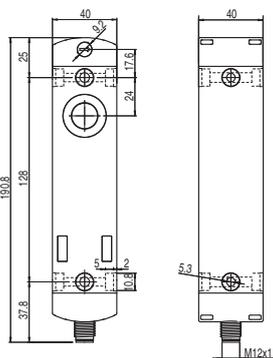

#### Actuator VN NS-F4•

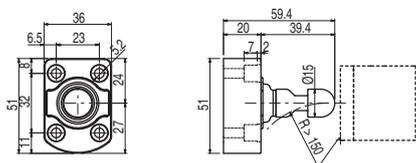

#### Accessories

Article	Description
VF KLB300	Set of two locking keys
	Extra copy of the locking keys to be purchased if further keys are needed (standard supply: 2 units). The keys of all switches have the same code. Other codes on request.

#### Extensions for release button

Article	Description	Drawing
VN NG-LP30	Metal extension for release button. For max. wall thickness of 30 mm	
VN NG-LP40	Metal extension for release button. For max. wall thickness of 40 mm	
VN NG-LP50	Metal extension for release button. For max. wall thickness of 50 mm	
VN NG-ERB	Red metal release button	

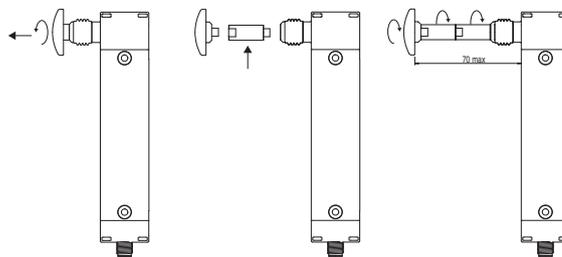

- Metal extensions can be combined with one another to achieve the desired length.
- Do not exceed an overall length of 70 mm between the release button and the switch.
- Use medium-strength thread locker to secure the extensions.

#### Series connection

To simplify series connections of the devices, various M12 connectors are available that allow complete wiring.

This solution significantly reduces installation times while at the same time maintaining the maximum safety levels PL e and SIL 3 for the interlocking function.

For further information see page 326.

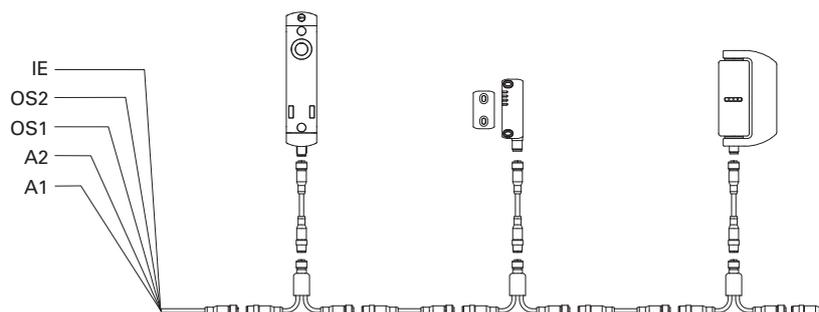



## General data

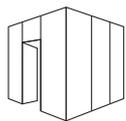

# P-KUBE

Building on its decades of experience in the field of safety switches for machinery guards, Pizzato Elettrica presents the **P-KUBE** family of safety handles. These handles, with their characteristic simplicity, versatility, and robust-

ness, constitute an effective solution for machine builders and installers.

Robust, and compatible with all guard-locking switches, the P-KUBE safety handles can be used on all types of door – both hinged and sliding, left or right – with a unique product code; and they adapt with ease to all installation situations, thanks to metal brackets with adjustable slots.

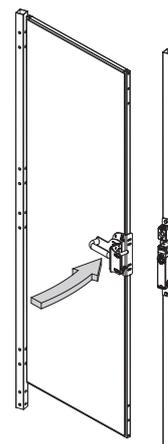

## P-KUBE Krome



- Modern and ergonomic design; fully concealed fixing screws and cabling.
- High anti bypass coding level, thanks to RFID technology actuators.
- Tamper prevention, from interlocking protection caps inserted to fixing screw holes.
- Illuminated control button, built into grip, to request functions like opening, reset, start and others.
- Front handle customisable in various finishes.
- Compatible with NG and NS series safety locking switches with RFID technology.
- Compatible with lock out devices for NG and NS series safety switches with RFID technology.



- Available also with integrated RGB LEDs, for local signalling of guard state.
- Ability to light up a single handle in green, yellow, red, blue, white, purple, and pale blue.



**P-KUBE 1**

- Can be used with FD series safety switches with separate actuator without lock, and FG series with lock.
- Robust metal self-centring pin, to ensure perfect alignment between door and jamb.
- Metal pin with mechanical door stop at limit of travel: no safety switch mechanical stress.
- Integral lock out device to which a padlock can be fitted, to prevent accidental guard closure.



**P-KUBE 2**

- Can be used with NG series safety switches with lock and RFID technology.
- Increased locked actuator holding force: up to 9,750 N.
- Door retaining force (30 N) when door unlocked, to prevent accidental opening.
- High level of anti bypass coding, thanks to actuators with RFID technology.
- Lock out device available on request, to which a padlock can be fitted to prevent accidental guard closure.
- Dual safety lock out: mechanical shielding, also of actuator RFID recognition.



**P-KUBE Fast**

- Can be used with FD series safety switches with separate actuator without lock, and FG series with lock.
- Compact, lightweight solution.
- Integrated internal lever for emergency guard opening.
- Sliding motion with internal mechanical stop, to prevent impacts between actuator and switch during closure.
- Integral lock out device to which a padlock can be fitted, to prevent accidental guard closure.



**P-KUBE Super**

- Designed for installation in particularly demanding work environments (rolling mills, for example).
- Dual centring pin, ideal for heavier doors with significant misalignment.
- Can be used with NG series safety switches with lock and RFID technology.
- Increased locked actuator holding force: up to 9,750 N.
- Door retaining force (30 N) when door unlocked, to prevent accidental opening.
- Metal pin with mechanical door stop at limit of travel: no safety switch mechanical stress.
- High anti bypass coding level, thanks to RFID technology actuators.
- Integral lock out device to which a padlock can be fitted, to prevent accidental guard closure.

## Description



The **P-KUBE 1** safety handles are designed to install Pizzato Elettrica's FD and FG series safety switches to machine guards quickly and easily, offering an effective solution to machine designers and installers for problems relating to the mechanical precision of guard movements.

The basic principle of this series of products is a mechanical centring and stop system along the direction of movement of the door. The centring system is extremely robust and can also be used in heavy duty applications or in the presence of careless personnel.

The lock out device is used to block the door in the open position and prevent an unexpected system restart when maintenance personnel access the system.

Thanks to their adjustable design these handles can be installed on different types of doors or barriers: hinged or sliding, right or left closing, as well as on various types of profiles.

## Robustness

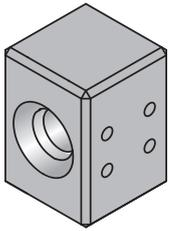

Thanks to its particular design and its special materials the safety handle can be used in heavy duty applications and with sturdy wide-ranging guards (min. 700 mm).

- Mounting system made up of robust painted brackets with thicknesses of 4 and 5 mm.
- Single-body centering block in stainless steel
- Large diameter centring pin in stainless steel
- Max. holding force of the actuator equal to 2800 N (versions with FG series switches).

- Stainless steel tamper proof bolts and screws and elastic washers (safety inserts excluded, see page 163).

## Mechanical stop

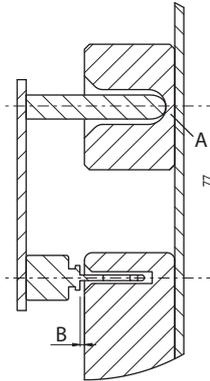

During door closing, the metal pin is flush to the bottom of the centring block (A) before the actuator can bump against the switch housing, leaving a safe distance (B), thus avoiding possible damage.

The metal pin is always flush on surfaces that transmit the impact to the frame and not to the switch, regardless of whether the lock out device is open or closed.

## Centring

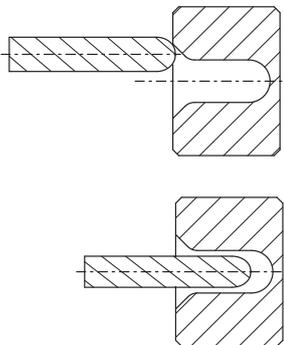

The centering of the pin on the block (both in stainless steel) forces the alignment between actuator and switch, ensuring a proper insertion preventing any risk of collisions.

This also allows a safe re-alignment of the protection to the frame, even in case of big axial misalignments.

## Holding force of the unlocked actuator

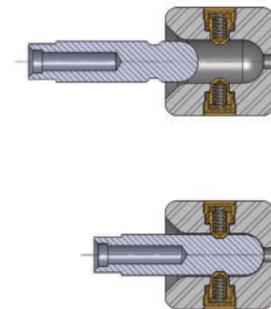

A version of the lock out device with 100 N holding force is available on request. With this new optional feature, the handle is kept in its limit-stop closed position; a moderately energetic pull is required to open the door. This device is ideal for all applications where multiple doors are unlocked simultaneously but only one is actually opened; all unlocked doors are held in position, thereby preventing vibrations or gusts of wind from opening them.

## Escape release button (FG series)

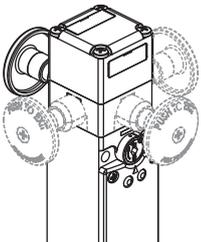

The FG series switches with actuator lock can be provided with an escape release button that, if oriented towards the inside of the machinery, allows accidentally trapped personnel to escape even during a blackout.

Pushing the button results in the same function as the auxiliary release device. To reset the switch, just return the button to its initial position.

The escape release button can be rotated and is available with different lengths. It is fixed to the switch by means of a screw allowing the installation of the switch both inside and outside the guards.

## Impossible to bypass with a separate actuator

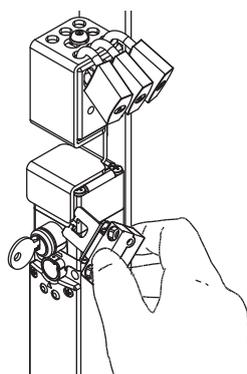

As soon as the lock out device has been actuated and locked, the slot in the switch for the actuator is no longer accessible.

If an operator is in possession of a second, separate actuator, he is not able to bypass blocking of the device and actuate the switch.



**Lock out device**

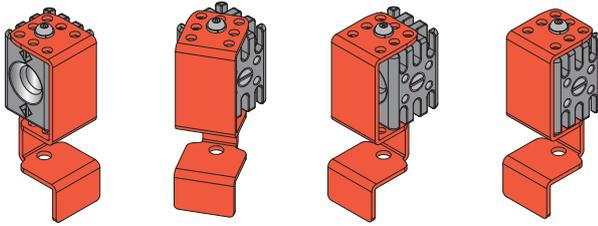

With a single operation, the lock out device enables the closure of both the centring hole and the slot for the actuator present in the switch, thus making the mechanical closure of the door and the electrical commutation of the switch contacts impossible.

The lock out device moves the red cover so that the holes in the cover do not coincide with the holes in the underlying metal block. This ensures that it is not possible to put a padlock on the device when it is open.

Up to 10 padlocks with a shackle diameter of up to 5 mm can be used.

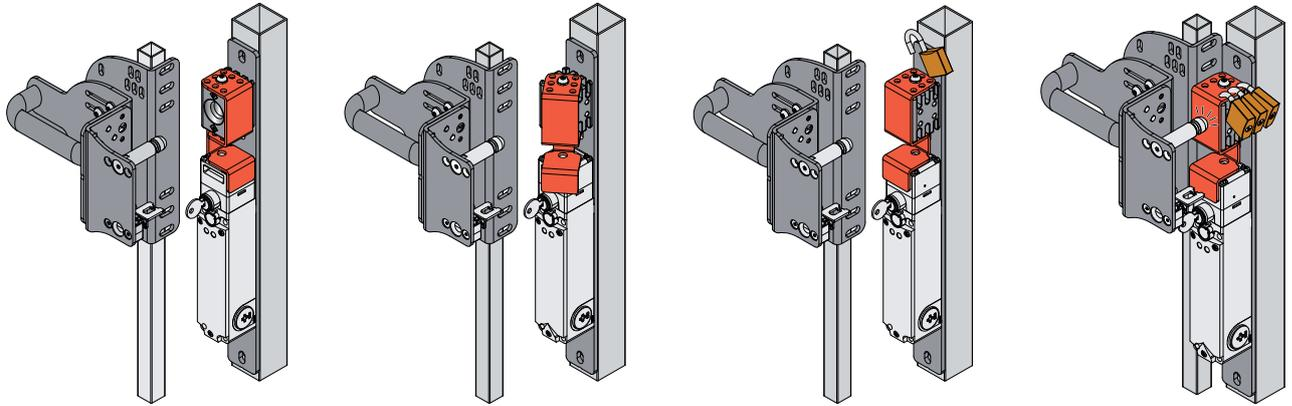

Lock out device open. Safety switch is accessible.

Closing of the lock out device.

Lock out device closed. Padlock insertion.

Lock out device locked. Padlock locked. Safety switch is not accessible.

**Turnable centring block**

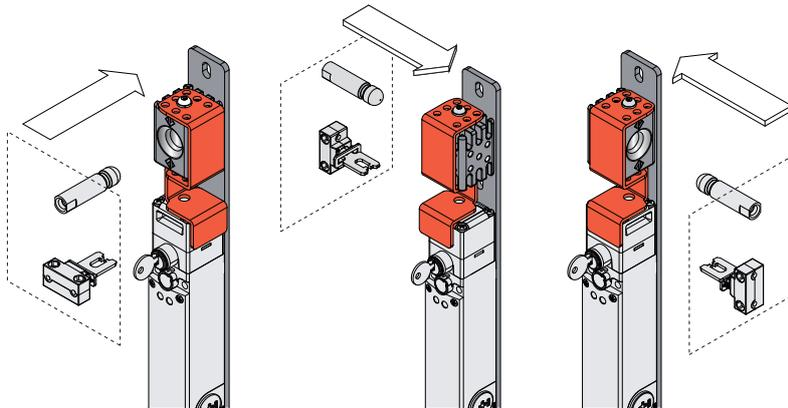

Thanks to its symmetrical design, the lock out device can be installed on hinged and sliding doors, with both right and left closing, while still retaining its centring function and allowing for the attachment of multiple padlocks.

**Flexibility and installation on different profiles**

The slots of the three brackets applied on the door allow to carry out independent adjustments on 3 axes, providing an extremely easy installation and avoiding any modification of the existing protection structure. Thanks to these adjustments the handle can be installed on door profiles with different dimensions, from 40x40 mm to 60x60 mm (A) on the jamb and from 20x20 mm to 40x40 mm (B) on the door. The brackets are bolted together by means of anti-tampering screws.

Thanks to its vertical design, the bracket containing the safety switch and the lock out device does not protrude beyond the jamb's profile.

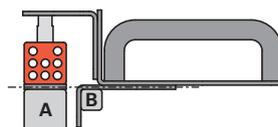
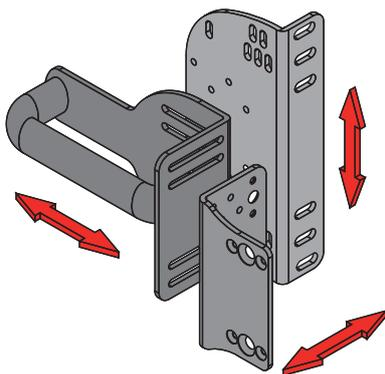

Hinged door and jamb frontally aligned

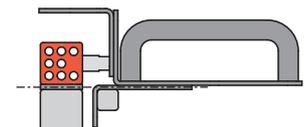

Hinged door and jamb frontally aligned

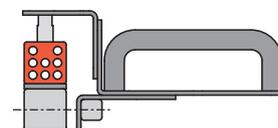

Hinged door and jamb axially aligned

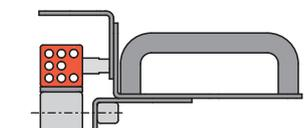

Sliding door and jamb axially aligned

## Code structure

**Attention!** The feasibility of a code number does not mean the effective availability of a product. Please contact our sales office.

### VF AP-P11A-200P

LOCK OUT device	
0	Centering block only
1	LOCK OUT device
2	LOCK OUT device with 100 N holding force

Grip	
P	plastic grip
M	metal grip
Z	without grip

Mounting bracket supplied for installation	
A	FD •••••
B	FG •••••••••
Z	without plate (B) for FG brackets
Y	without plate (A) for FD brackets

Plate configuration	
200	Configuration with adjustable "L" plate for door profiles
201	Configuration with adjustable plain plate for door profiles
202	Configuration without adjustable plate for door profiles

Note: the handle is supplied complete with switch actuator as well as fastening screws for the grip, the switch, the actuator, and between the plates.

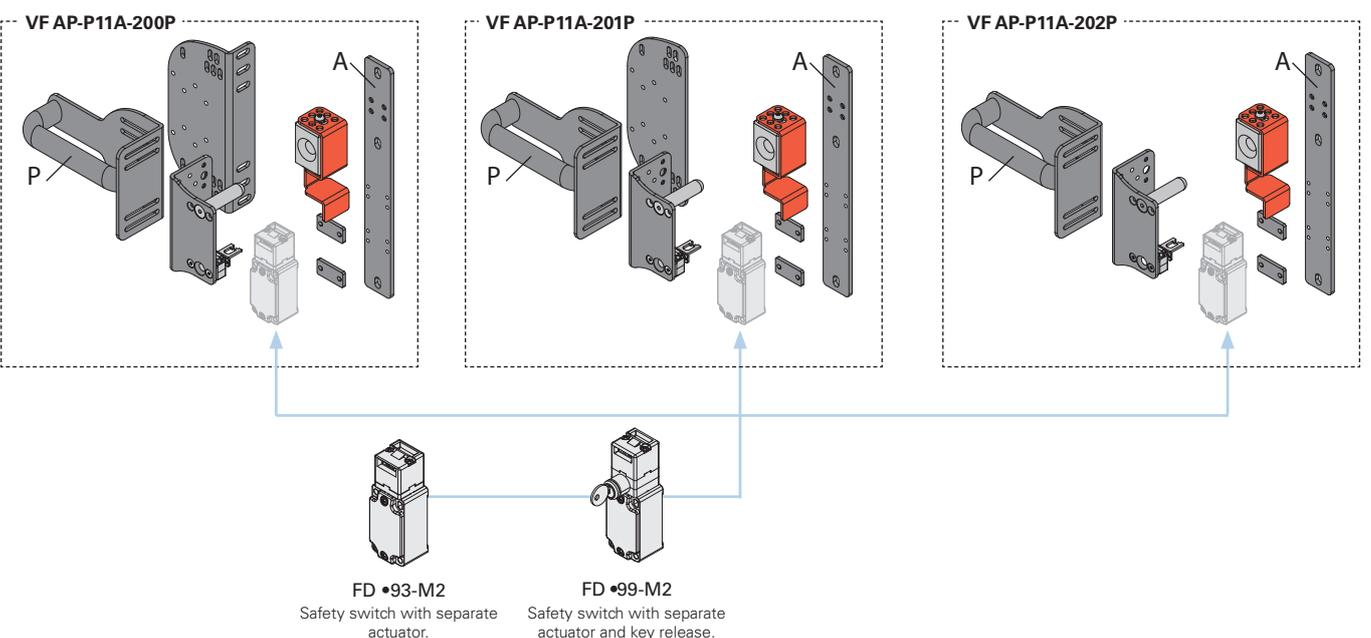
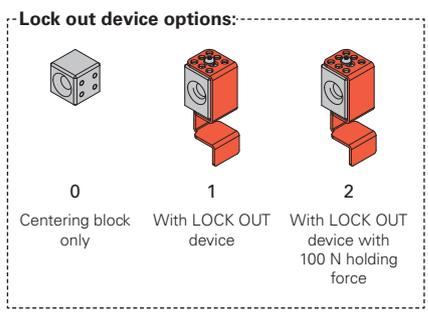
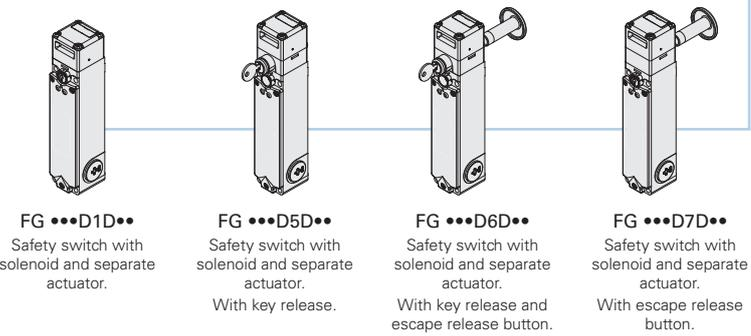
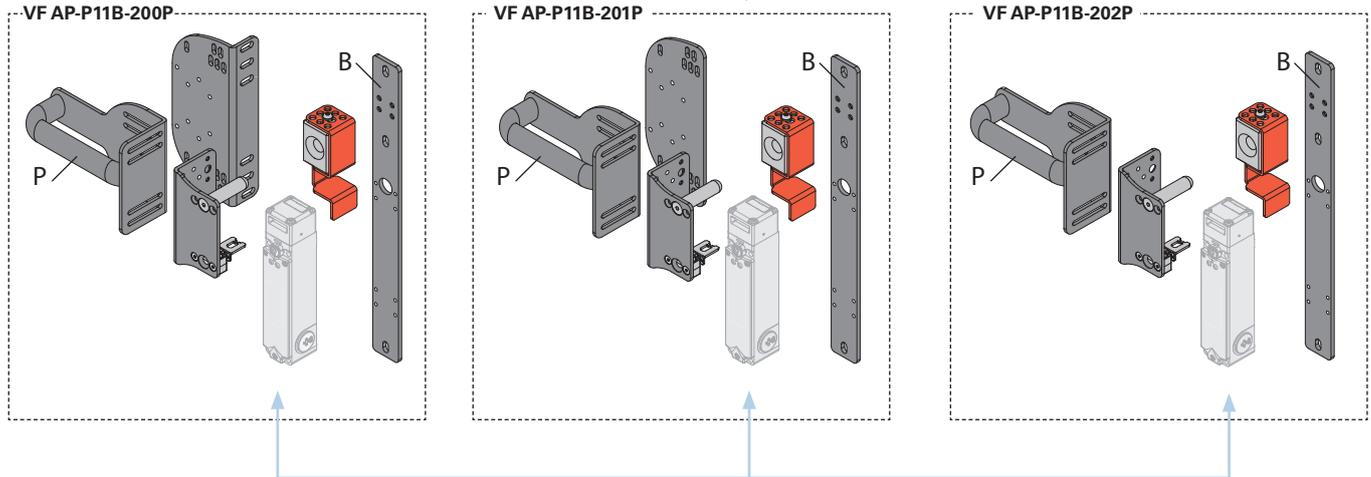

→ article sold separately

For articles and options of the FG series switches see page 107.  
For articles and options of the FD series switches see page 15.

**Dimensional drawings**

Safety handle VF AP-P1•A-200•

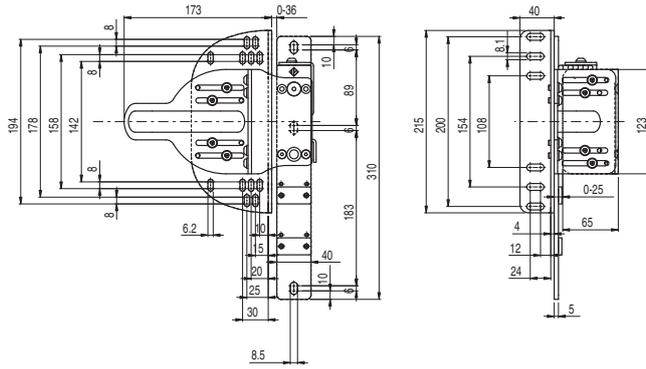

Safety handle VF AP-P1•A-201•

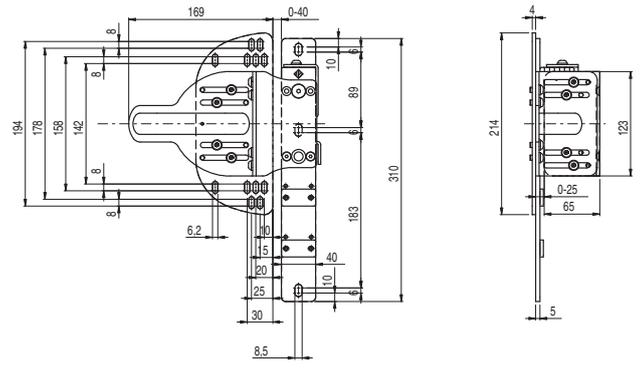

Safety handle VF AP-P1•A-202•

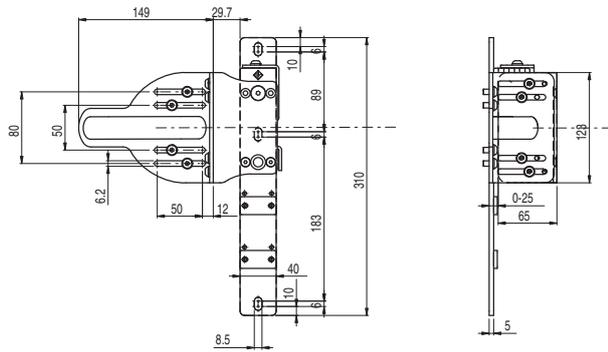

Safety handle VF AP-P1•B-200•

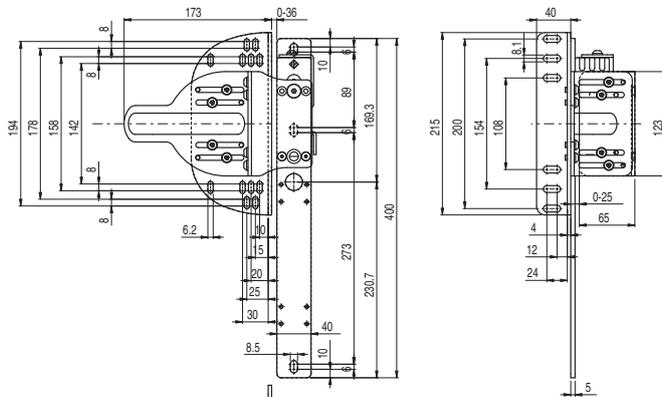

Safety handle VF AP-P1•B-201•

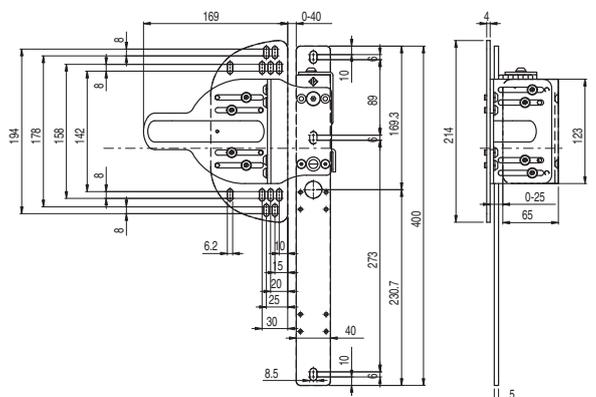

Safety handle VF AP-P1•B-202•

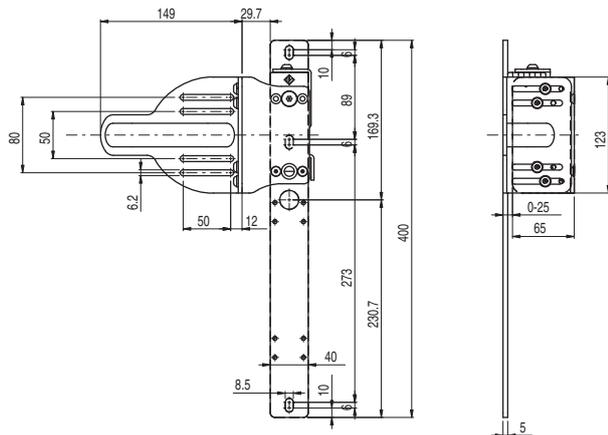

All values in the drawings are in mm

Accessories See page 321

→ The 2D and 3D files are available at [www.pizzato.com](http://www.pizzato.com)

## Accessories

## Profiled plate



Profiled plate to be installed under the fixing plate of the switch. Suitable for both right and left mounting and provided with holes, this plate can be used for the installation of housings for the Pizzato Elettrica EROUND line panel buttons (by means of common self-threading screws available on the market).

Article	Description
VF AP-C001	Profiled lateral plate

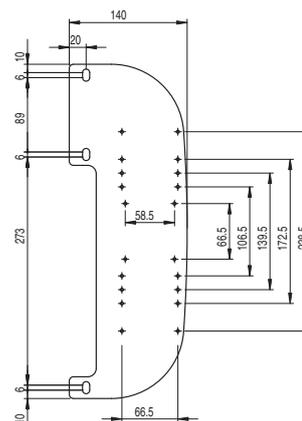

## Adhesive labels for escape release button



Polycarbonate yellow adhesive, rectangular, 300x32 mm, red inscription. It has to be fixed on the internal part of the jamb and helps finding the escape release button.

Article	Description and language	
VF AP-A1AGR01	PREMERE PER USCIRE	ita
VF AP-A1AGR02	PUSH TO EXIT	eng
VF AP-A1AGR04	ZUM ÖFFNEN DRÜCKEN	deu
VF AP-A1AGR05	POUSSER POUR SORTIR	fra
VF AP-A1AGR06	PULSAR PARA SALIR	spa
VF AP-A1AGR07	НАЖАТЬ ДЛЯ ВЫХОДА	rus
VF AP-A1AGR08	NACISNAĆ ABY WYJŚĆ	pol
VF AP-A1AGR09	PRESSIONAR PARA SAIR	por

## Safety inserts set



Set with 3 x 1/4" hexagonal safety inserts. Connection DIN 3126, C 6.35. Hex mount with hole.

The P-KUBE 1 safety handle is provided with tamper-proof screws. Therefore all 3 safety inserts of the set are required.

Article composition VF AP-K01:

Qty	Description		Length
1	Hexagonal insert 1/4"  for M5 screws	3 mm	25 mm
1	Hexagonal insert 1/4"  for M6 screws	4 mm	25 mm
1	Hexagonal insert 1/4"  for M8 screws	5 mm	25 mm

Complete housings for profiled plate



ES AC32010

Description	Features	Diagram
<b>Button - 1NO</b> E2 1PU2R421L35 Contacts 1x E2 CF10G2V1	flush, spring-return, green pos. 2   pos. 3   pos. 1 /   1NO   /	
<b>Button - 1NC</b> E2 1PU2S321L1 Contacts 1x E2 CF01G2V1	projecting, spring-return, red pos. 2   pos. 3   pos. 1 /   1NC ⊖   /	



ES AC32043

Description	Features	Diagram
<b>Indicator light</b> E2 1LA210 LED unit E2 LF1A2V1	white White LED, 12 ... 30 Vac/dc	
<b>Button - 1NO</b> E2 1PU2R4210 Contacts 1x E2 CF10G2V1	flush, spring-return, green pos. 2   pos. 3   pos. 1 /   1NO   /	



ES AC33076

Description	Features	Diagram
<b>Illuminated button - 1NO</b> E2 1PL2R2210 LED unit E2 LF1A2V1 Contacts 1x E2 CF10G2V1	flush, spring-return, white White LED, 12 ... 30 Vac/dc pos. 2   pos. 3   pos. 1 /   LED   1NO	
<b>Illuminated button - 1NO</b> E2 1PL2R5210 LED unit E2 LF1A2V1 Contacts 1x E2 CF10G2V1	flush, spring-return, yellow White LED, 12 ... 30 Vac/dc pos. 2   pos. 3   pos. 1 /   LED   1NO	
<b>Emergency button Ø 40 mm- 2NC</b> E2 1PER24531	rotary release, Ø 40 mm, red	
<b>Label with shaped hole</b> VE TF32G5700 Contacts 2x E2 CF01G2V1	yellow, 30x60 mm rectangular, no engraving pos. 2   pos. 3   pos. 1 1NC ⊖   /   1NC ⊖	

## Description



Together with the NG series RFID safety switches with guard locking, the **P-KUBE 2** safety handles form an integrated locking system for guards that enables access control to dangerous areas, offering an effective solution to designers and installers for problems related to the mechanical precision of the movements of the guard.

The basic principle of this product series is to use the self-centering properties of the actuator on the NG switch by means of hinge pins and a large insertion range into the device. The use of fixing plates with slotted holes also allows for easy and quick alignment of the switch and actuator.

The lock out device is used to block the door in the open position and prevent an unexpected system restart when maintenance personnel access the system.

Thanks to their adjustable design these handles can be installed on different types of doors or barriers: hinged or sliding, right or left closing, as well as on various types of profiles.

## Maximum safety with a single device

# PL e+ SIL 3

The P-KUBE 2 safety handles can be combined with the NG series switches. As a result, the maximum PL e and SIL 3 safety levels can be achieved through the use of a single device on a guard. This avoids expensive wiring in the field and allows faster installation. Inside the control cabinet, the two electronic safety outputs must be connected to a safety module with OSSD inputs or to a safety PLC.

## Easy to use

There are no specific sequences required for opening or closing the door, but only a single opening / closing movement.

If the door interlock is realised by means of a handle provided with a release push button, the door can be opened with a single movement even under stress (panic situations).

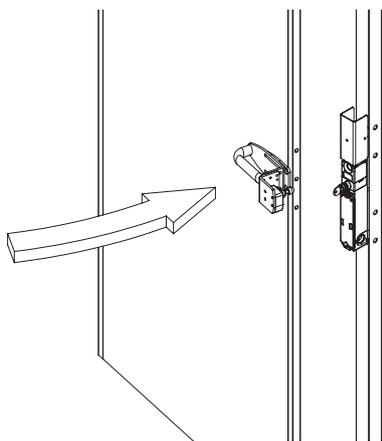

## Holding force of the locked actuator

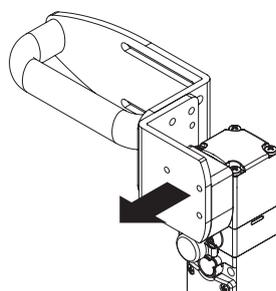

**9750 N** The strong interlocking system guarantees a maximum actuator holding force of  $F_{1max} = 9750$  N. This is one of the highest values currently available on the market today, making this device suitable for heavy-duty applications.

## Holding force of the unlocked actuator

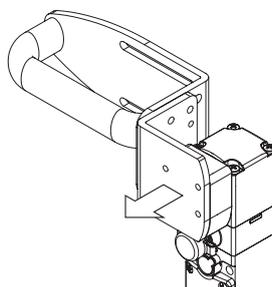

The inside of each switch features a device which holds the actuator in its closed position. Ideal for all those applications where several doors are unlocked simultaneously, but only one is actually opened. The device keeps all the unlocked doors in their position with a retaining force of 30 N, stopping any vibrations or gusts of wind from opening them.

## Sturdiness and easy installation

The handle is provided with 5 mm thick sturdy brackets in painted steel. The slots in the brackets allow independent adjustments to be performed. This ensures easy installation, eliminating the need to make changes to structure of the existing guard.

The adjustments make it possible to attach the handle to aluminium profiles or steel frames of various dimensions, from 40 x 40 mm to 80 x 80 mm for the frame jamb (A) and from 20 x 20 mm to 40 x 40 mm for the door (B).

It can be installed both on hinged doors and sliding doors, either with right or left closing.

The handle is supplied with all of the components necessary for fastening at the appropriate distances with tamper-proof screws. The installer only has to assemble the components according to the application, fix the selected switch (supplied separately) and make centring adjustments.

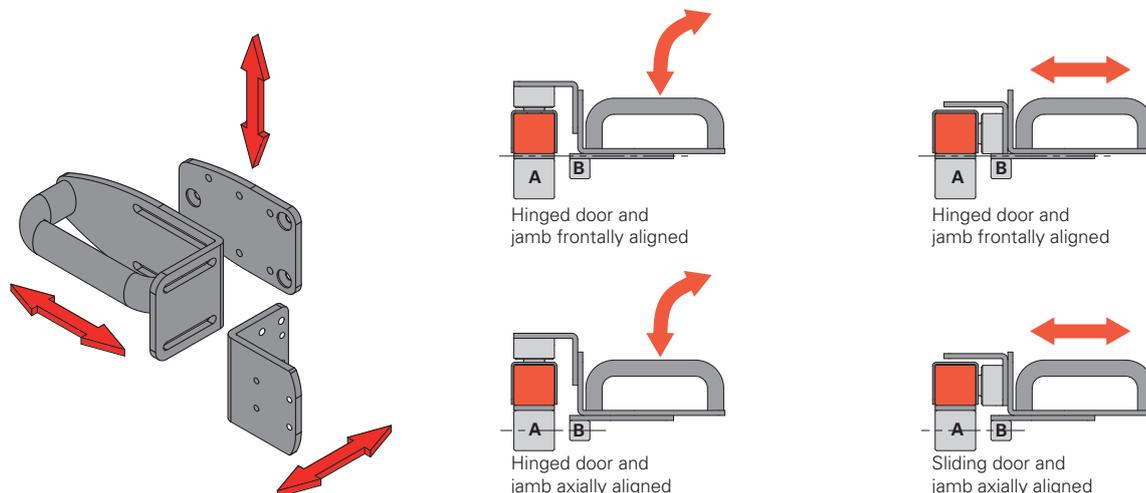

**Padlocking option for protecting against errors**

The lock out device is simply pushed downward to expose the holes for mounting padlocks. As a result, padlocks can no longer be mounted incorrectly, since the holes are not exposed until the switch is fully locked. 9 holes for padlocks with a diameter of 7 mm are present. The head of the switch can be quickly rotated in four different directions after loosening the fixing screws, while the lock out device reliably protects on 3 sides. The lock out device can thus be used on hinged and sliding doors – with both right and left closing – without any modification.

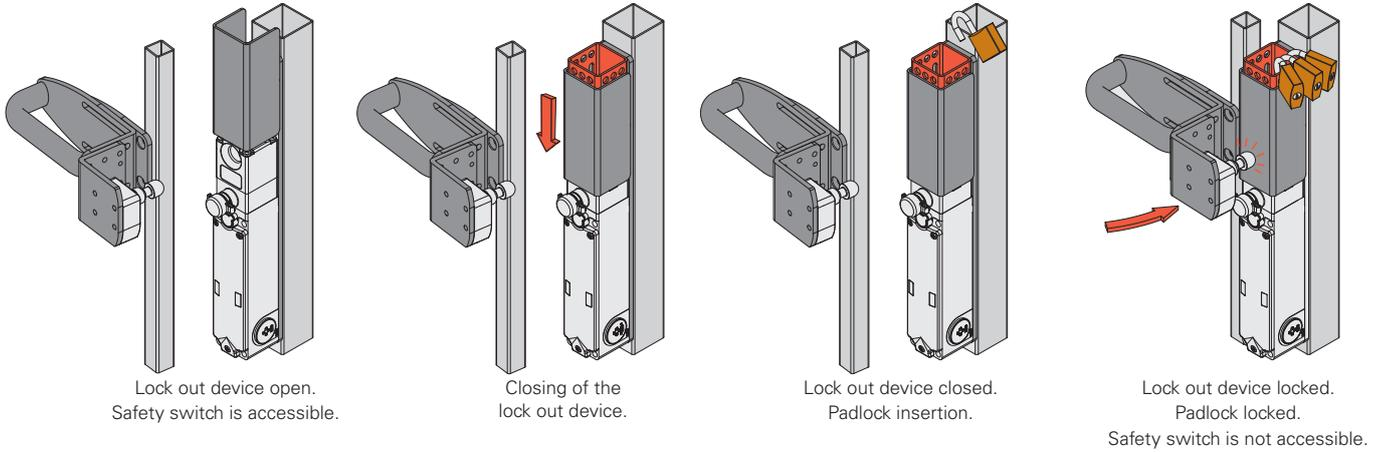

**Lock out: maximum safety with just one movement**

With a single operation, the lock out device can close the centring hole in the NG switch as well as shield the RFID recognition system for detecting the actuator. Accidental closing of the guard is thereby prevented by inhibiting both the mechanical locking of the door and the electrical switching of the switch contacts.

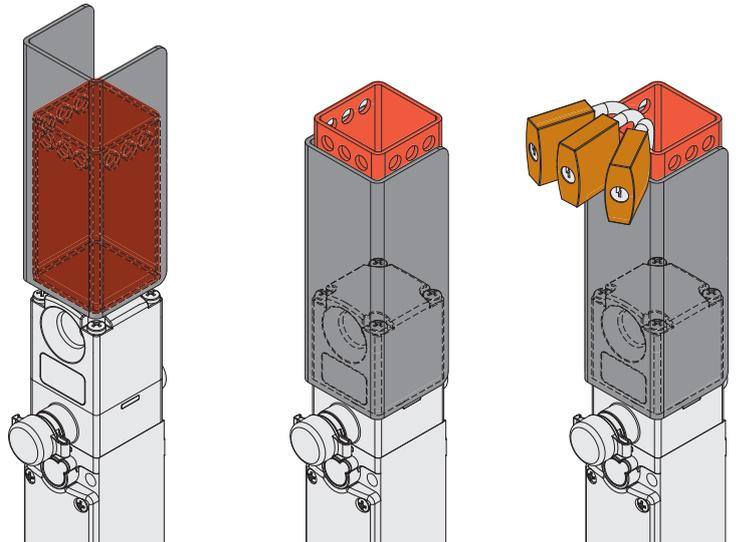

**Head rotation**

Because the lock out device covers the switch head in the 3 possible approach directions, it can be used on hinged and sliding doors – with both right and left closing – without any additional modification.

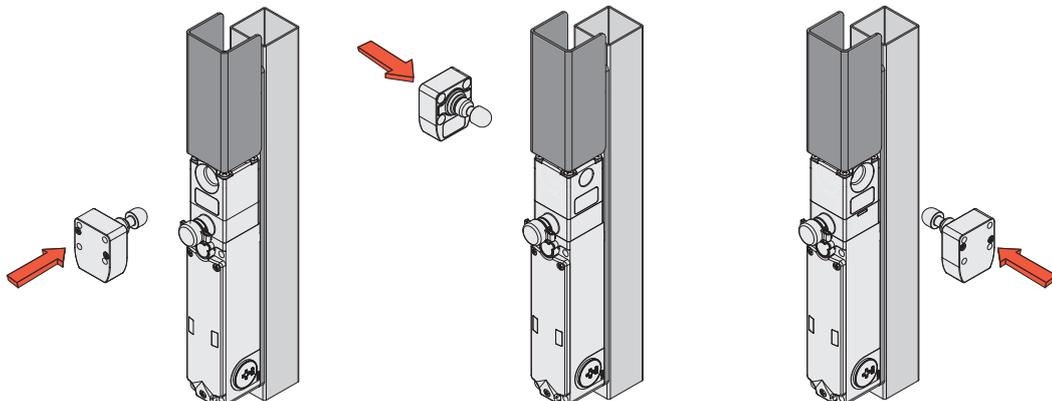

## Code structure

**Attention!** The feasibility of a code number does not mean the effective availability of a product. Please contact our sales office.

### AP G1A-111P

LOCK OUT device	
1	with LOCK OUT device
0	Without LOCK OUT device

Grip	
P	plastic grip
M	metal grip
Z	without grip

Fixing on frames	
A	Long plate
B	Short plate
Z	Without plate

Plates for fastening the door handle	
000	Without door fastening plate
111	3 plates with multiple fastening options
011	2 plates with multiple fastening options
200	Configuration with 1 fixed plate

Note: the handle is supplied with fastening screws for the grip, for the switch, and for bolting the plates together.

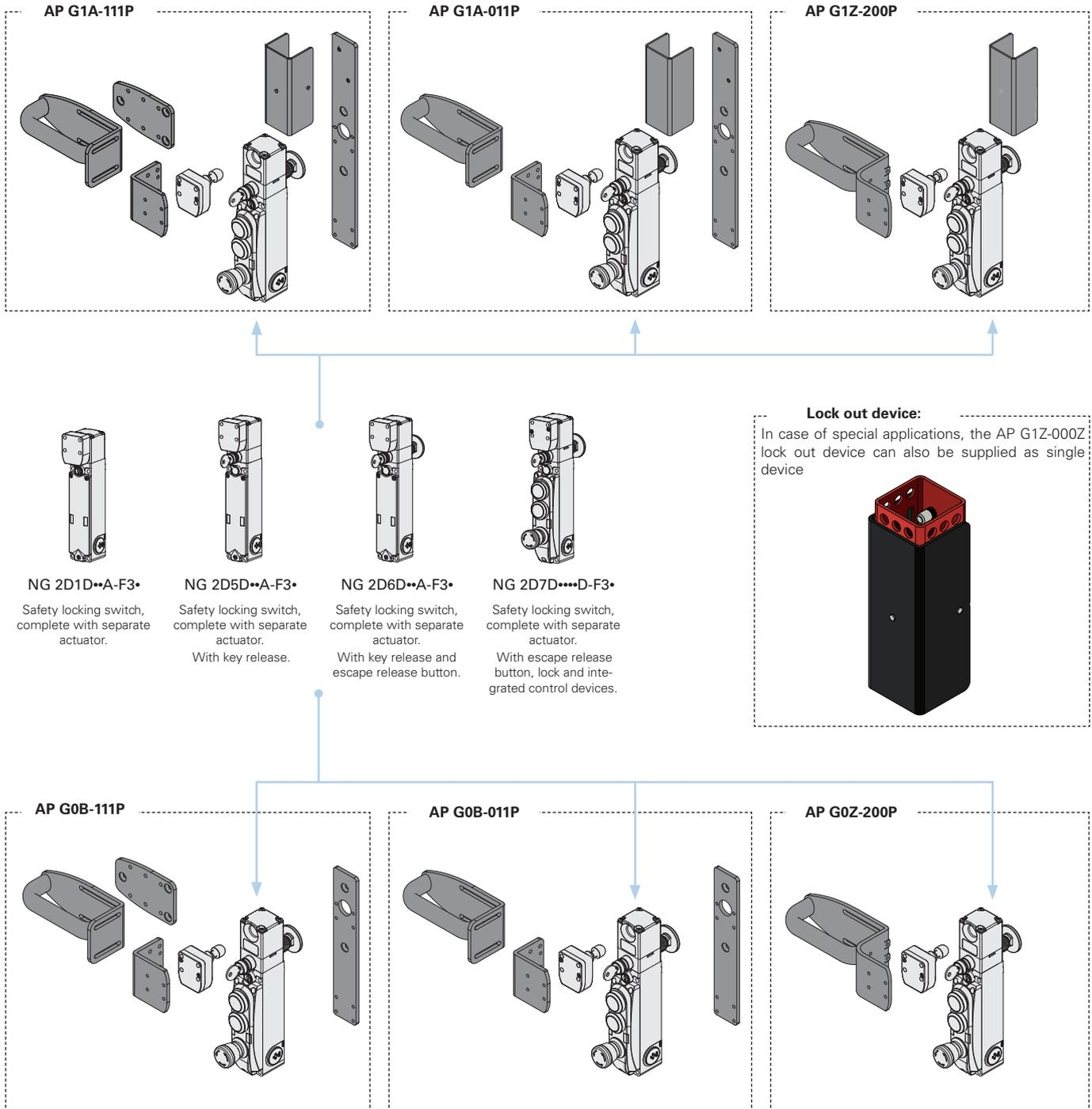

**Lock out device:**  
In case of special applications, the AP G1Z-000Z lock out device can also be supplied as single device

- NG 2D1D-A-F3**  
Safety locking switch, complete with separate actuator.
- NG 2D5D-A-F3**  
Safety locking switch, complete with separate actuator. With key release.
- NG 2D6D-A-F3**  
Safety locking switch, complete with separate actuator. With key release and escape release button.
- NG 2D7D-D-F3**  
Safety locking switch, complete with separate actuator. With escape release button, lock and integrated control devices.

→ Sold separately as accessory

The NG series safety switch is also available in other versions. For further information see page 131.



**Dimensional drawings**

AP G1A-111 • safety handles

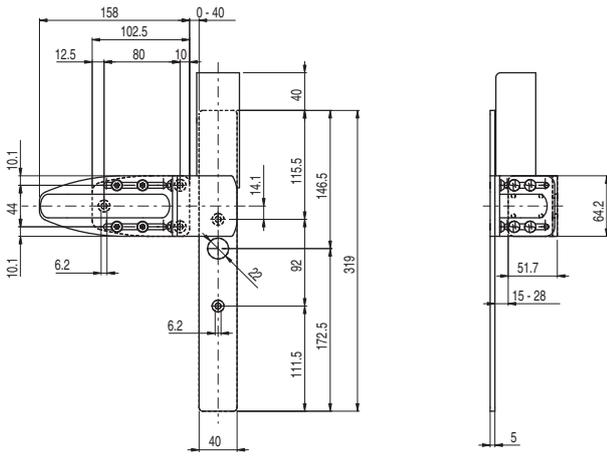

AP G1A-011 • safety handles

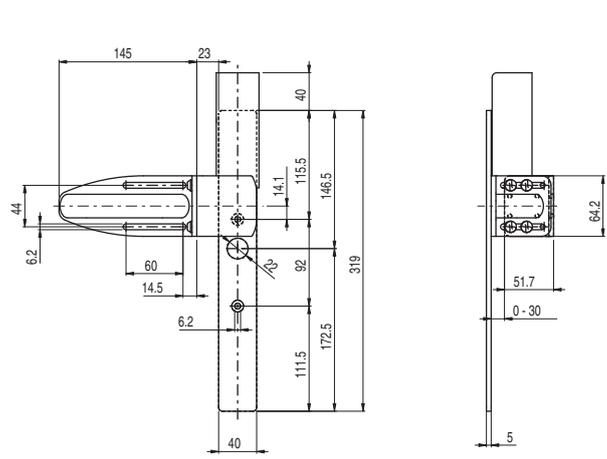

AP G1Z-200 • safety handles

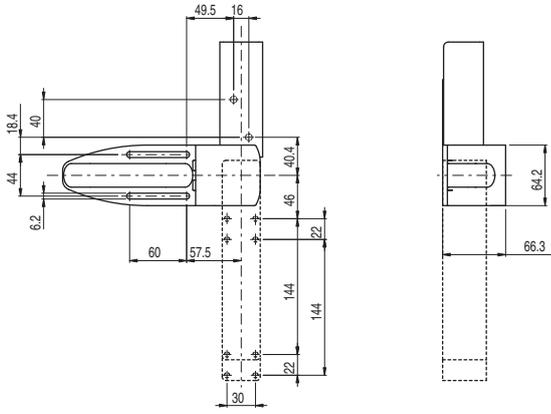

AP G0B-111 • safety handles

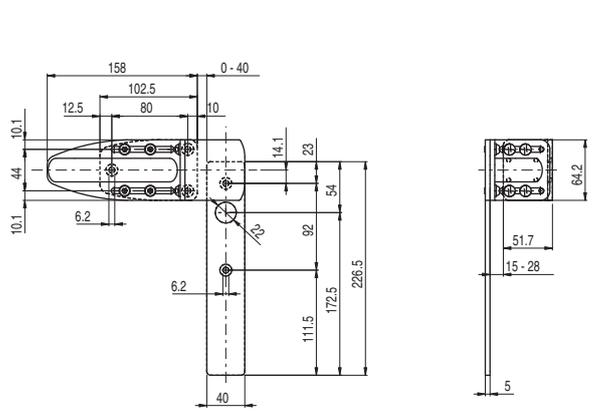

AP G0B-011 • safety handles

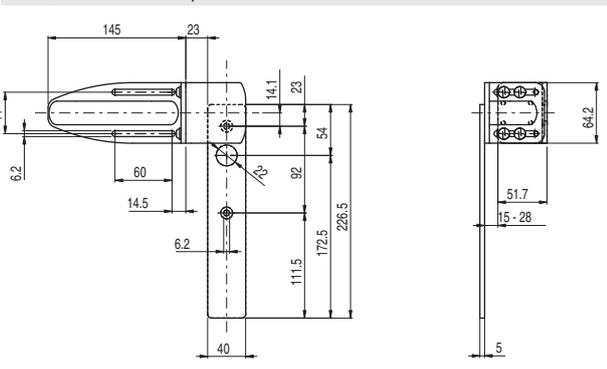

AP G0Z-200 • safety handles

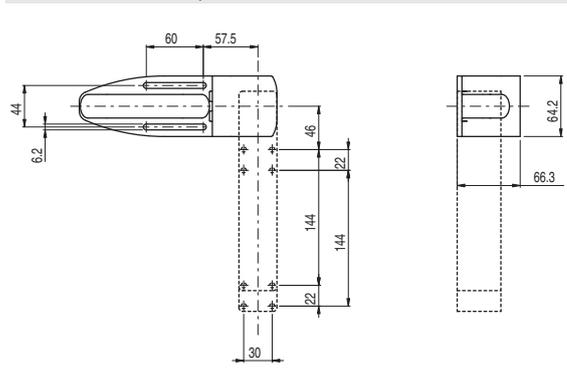

All values in the drawings are in mm

Accessories See page 321

→ The 2D and 3D files are available at [www.pizzato.com](http://www.pizzato.com)



### Extensions for release button

Article	Description	Drawing
VN NG-LP30	Metal extension for release button. For max. wall thickness of 30 mm	
VN NG-LP40	Metal extension for release button. For max. wall thickness of 40 mm	
VN NG-LP50	Metal extension for release button. For max. wall thickness of 50 mm	
VN NG-LP60	Metal extension for release button. For max. wall thickness of 60 mm	
VN NG-ERB	Red metal release button	

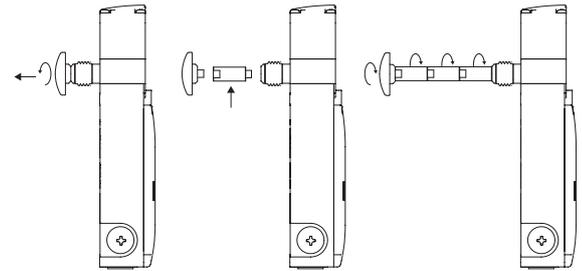

- Metal extensions can be combined with one another to achieve the desired length.
- Do not exceed an overall length of 500 mm between the release button and the switch.
- Use medium-strength thread locker to secure the extensions.

### Complete housings for profiled plate



#### ES AC32010

Description	Features	Diagram
<b>Button - 1NO</b> E2 1PU2R421L35 Contacts 1x E2 CF10G2V1	flush, spring-return, green pos. 2   pos. 3   pos. 1 /   1NO   /	
<b>Button - 1NC</b> E2 1PU2S321L1 Contacts 1x E2 CF01G2V1	projecting, spring-return, red pos. 2   pos. 3   pos. 1 /   1NC ⊖   /	

#### ES AC32043

Description	Features	Diagram
<b>Indicator light</b> E2 1ILA210 LED unit E2 LF1A2V1	white White LED, 12 ... 30 Vac/dc	
<b>Button - 1NO</b> E2 1PU2R4210 Contacts 1x E2 CF10G2V1	flush, spring-return, green pos. 2   pos. 3   pos. 1 /   1NO   /	

#### ES AC33076

Description	Features	Diagram
<b>Illuminated button - 1NO</b> E2 1PL2R2210 LED unit E2 LF1A2V1 Contacts 1x E2 CF10G2V1	flush, spring-return, white White LED, 12 ... 30 Vac/dc pos. 2   pos. 3   pos. 1 /   LED   1NO	
<b>Illuminated button - 1NO</b> E2 1PL2R5210 LED unit E2 LF1A2V1 Contacts 1x E2 CF10G2V1	flush, spring-return, yellow White LED, 12 ... 30 Vac/dc pos. 2   pos. 3   pos. 1 /   LED   1NO	
<b>Emergency button Ø 40 mm- 2NC</b> E2 1PERZ4531	rotary release, Ø 40 mm, red	
<b>Label with shaped hole</b> VE TF32G5700 Contacts 2x E2 CF01G2V1	yellow, 30x60 mm rectangular, no engraving pos. 2   pos. 3   pos. 1 1NC ⊖   /   1NC ⊖	

## Description



The **P-KUBE Fast** safety handles are designed to install Pizzato Elettrica's FD and FG series safety switches to machine guards quickly and easily, offering an effective solution to machine designers and installers for problems relating to the mechanical precision of guard movements, as well as for critical environmental conditions.

The P-KUBE Fast safety handles, unlike other products on the market, combine their compactness and lightness resulting from the sliding movement, with the robustness of the upper end models, which are distinguished by a higher weight, more bulky dimensions and greater constructive complexity.

## Structure

The P-KUBE Fast handle is light and compact, has a galvanized and painted metal frame and an ergonomic plastic or aluminium grip for comfortable and easy use of the door handle itself.

The absence of screws and removable components prevents any tampering.

## Handle lock positions

There is a snap-on device that retains the handle in two positions: when it is pulled out, so as to contribute to the retaining force exerted by the actuator, and when retracted, to avoid undesirable movements caused by machine vibrations.

## Centring

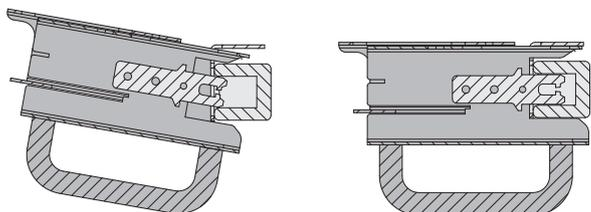

The "C"-shaped profile facilitates centring of the device when closing a guard that is not perfectly aligned with the frame. This enables an optimum alignment between actuator and switch, preventing any damage due to possible collisions.

## Flexibility during installation

Thanks to its symmetrical design the device can be installed on hinged and sliding doors, either with right or left closing, without requiring any further adjustment.

The slotted brackets and the large actuator travel (60 mm) allow the device to be installed and adjusted on profiles of various sizes.

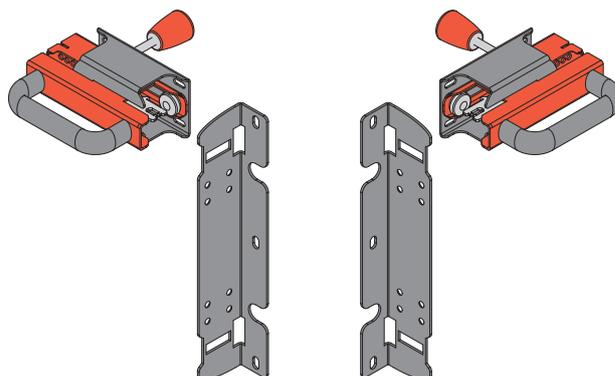

### Protection of actuator and switch

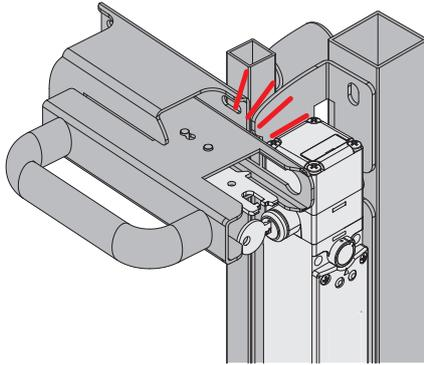

Thanks to the handle structure and the fixing bracket of the switch, both the switch and the actuator can be safely installed preventing any damage due to possible collisions. Any impacts resulting from incorrect actuation are completely absorbed on the handle frame.

### Mechanical stop

During door closing, a mechanical stop (A) prevents possible impacts between the actuator and the switch by constantly ensuring a safety distance (B) between these two components and the switch housing.

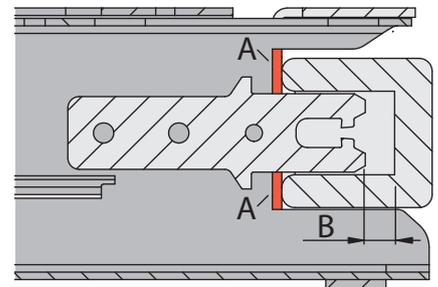

### Internal lever for emergency escape

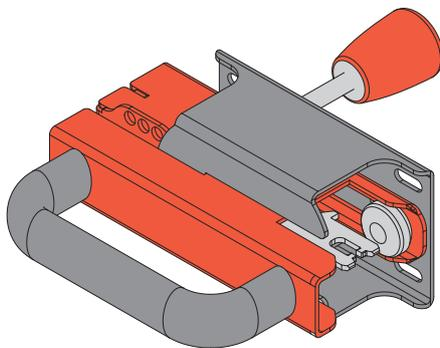

Optional lever for emergency opening from the inside: it ensures that operating personnel can exit the area should they accidentally become trapped within the dangerous area. It can be combined only with switches without lock (e.g. FD ●93-M2) or switches with escape release button (e.g. FG ●●●D6D●●).

### Lock out device

The lock out device integrated in the structure of the P-KUBE Fast handles allows up to 6 padlocks to be hooked in with a shackle diameter of 6 mm to prevent unintentional closing of the guard.

When the lock out device is activated, the mechanical closing of the door and the electrical switching of the switch contacts is prevented.

The lock out device can only be unlocked when all locks have been removed, i.e. when all operators have left the danger zone.

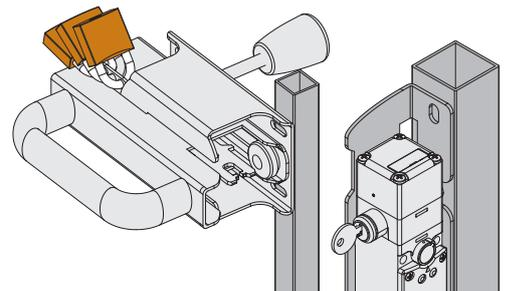

## Code structure

**Attention!** The feasibility of a code number does not mean the effective availability of a product. Please contact our sales office.

## VF AP-S13BP-200

## Mounting bracket supplied for installation

A	FD ••••
B	FG ••••••••

## Internal lever for emergency escape

P	internal lever for emergency escape
Z	without internal lever for emergency escape

## Plate configuration

001	without plate, with aluminium grip
002	without plate, with plastic grip
200	with plate for FG: with screwed-on aluminium grip
201	with plate for FD: with screwed-on aluminium grip
300	with plate for FG: with screwed-on plastic grip
301	with plate for FD: with screwed-on plastic grip

Note: the handle is supplied complete with switch actuator and fastening screws for fixing the switch to the plate.

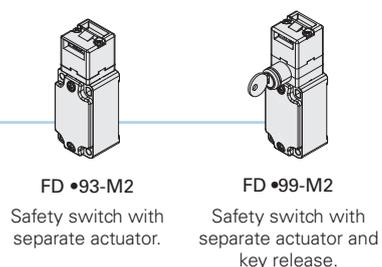
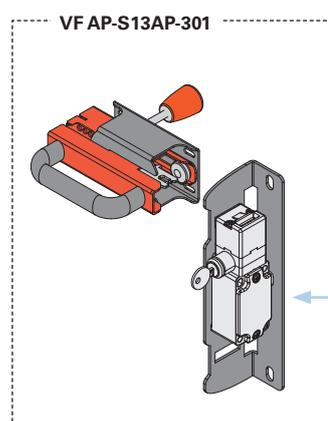
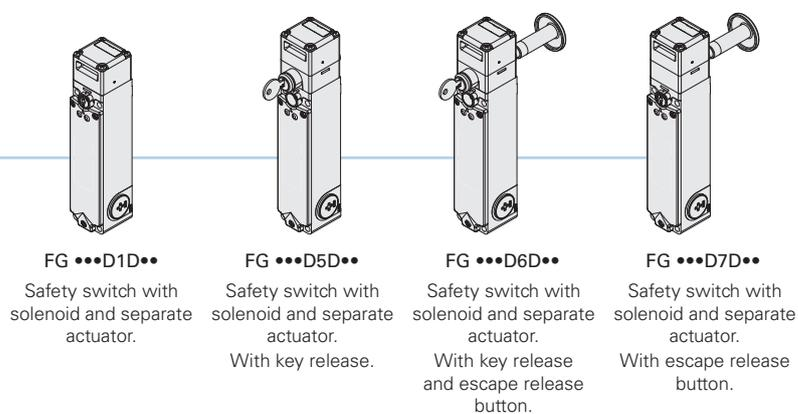
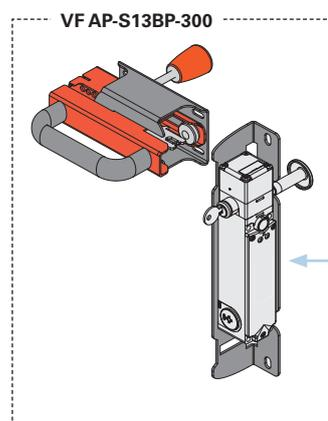

→ article sold separately

For articles and options of the FG series switches see page 107.  
For articles and options of the FD series switches see page 15.

**Dimensional drawings**

Safety handle VF AP-S13BP-300

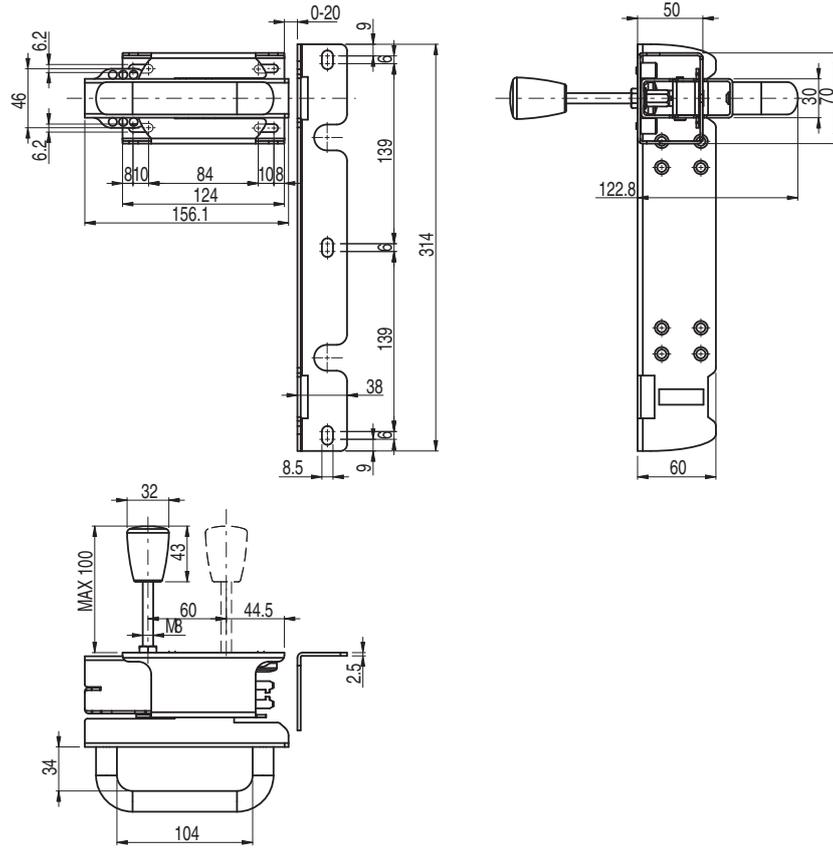

Safety handle VF AP-S13AP-301

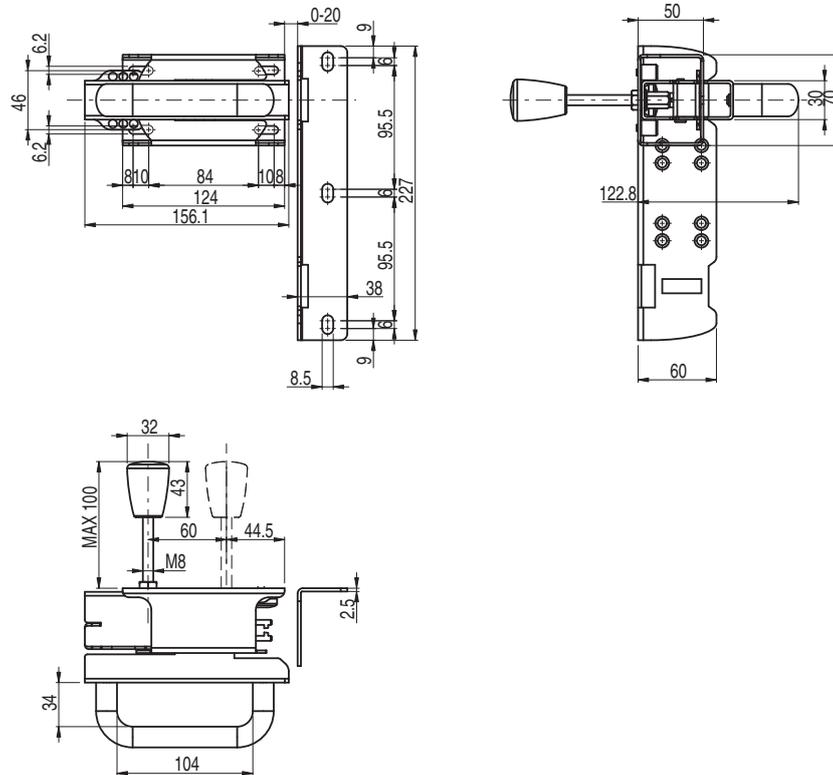

All values in the drawings are in mm

Accessories See page 321

→ The 2D and 3D files are available at [www.pizzato.com](http://www.pizzato.com)

## Description



Together with the NG series RFID safety switches with guard locking, the **P-KUBE Super** safety handles form an integrated locking system for guards that enables access control to dangerous areas, offering an effective solution to designers and installers for problems related to the mechanical precision of the movements of the guard.

Designed as an evolution of the P-KUBE 2 handles, the P-KUBE Super handles with double centering pin are specifically designed for guards installed in heavy-duty work environments (e.g. rolling mills, iron and steel plants, etc.) where very heavy doors or doors with such dimensions as to generate high misalignments between the movable and fixed parts of the guard may be present.

The integrated lock out device is used to block the door in the open position and prevent an unexpected system restart when maintenance personnel access the system.

Thanks to their adjustable design these handles can be installed on different types of doors or barriers: hinged or sliding, right or left closing, as well as on various types of profiles.

## Maximum safety with a single device

# PL e + SIL 3

The P-KUBE Super safety handles can be combined with the NG series switches. As a result, the maximum PL e and SIL 3 safety levels can be achieved through the use of a single device on a guard. This avoids expensive wiring in the field and allows faster installation. Inside the control cabinet, the two electronic safety outputs must be connected to a safety module with OSSD inputs or to a safety PLC.

## Dual centring pin

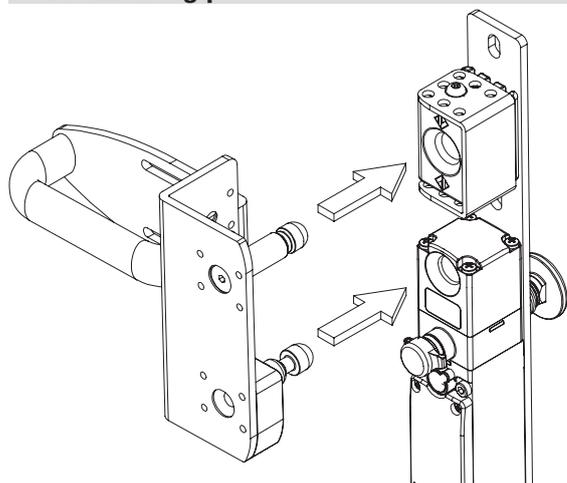

When closing the guard, the upper metal pin attached to the handle plate hits the bottom of the centering block (A) before the actuator hits the switch housing, leaving a safe distance (B) to avoid collisions between the devices.

The upper metal centering pin can also only hit surfaces that transmit the impact to the support structure of the guard but not to the switch itself, which is thus relieved of all mechanical loads when the door is opened and closed.

The coupling with the actuators of the NG series with hinge pin allows further adaptation to the centering hole even with doors with inaccurate opening, thus avoiding continuous maintenance operations to realign the actuator and switch.

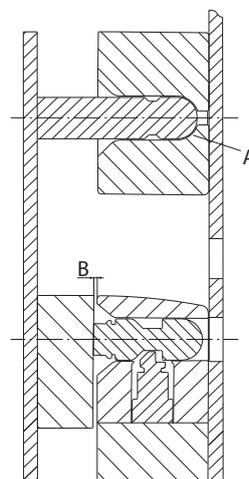

## Sturdiness and easy installation

The handle is provided with 5 mm thick sturdy brackets in painted steel. The slots in the brackets allow independent adjustments to be performed. This ensures easy installation, eliminating the need to make changes to structure of the existing guard.

The adjustments make it possible to attach the handle to aluminium profiles or steel frames of various dimensions, from 40 x 40 mm to 80 x 80 mm for the frame jamb (A) and from 20 x 20 mm to 40 x 40 mm for the door (B).

It can be installed both on hinged doors and sliding doors, either with right or left closing.

The handle is supplied with all of the components necessary for fastening at the appropriate distances with tamper-proof screws. The installer only has to assemble the components according to the application, fix the selected NG series switch (supplied separately) and make centring adjustments.

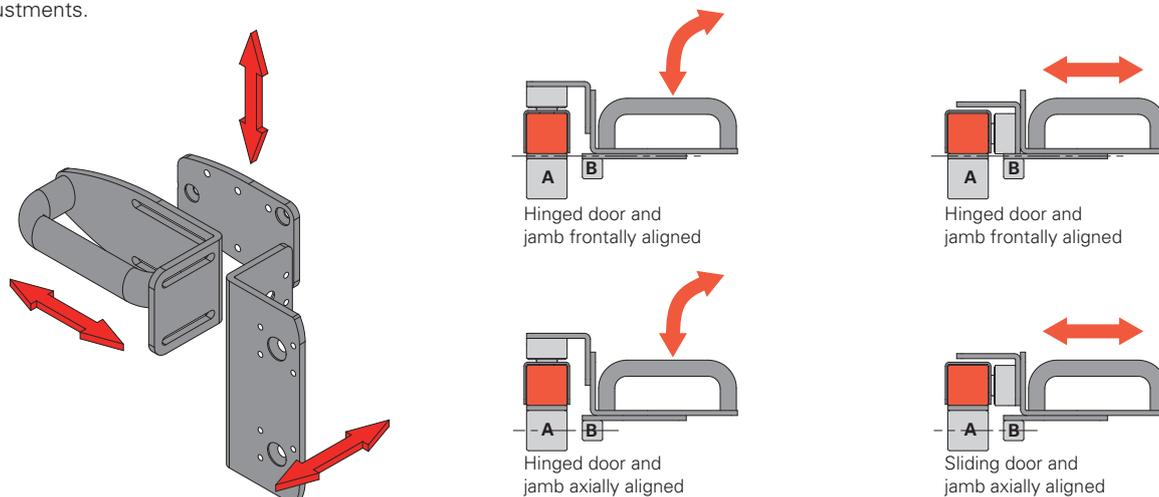



**Lock out device**

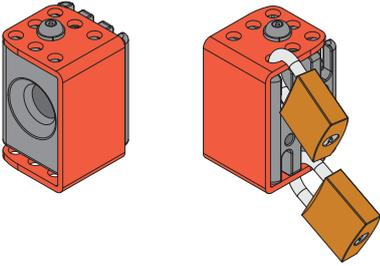

With a single operation, the lock out device can close the centering hole, making it impossible to mechanically close the door. Simply turn the red cover so that the centering hole is completely covered and the holes on the top of the cover match the holes in the metal block underneath.

With the lock out device activated, it is possible to insert up to 12 padlocks with a shackle diameter of 5 mm; this feature makes the P-KUBE Super handle particularly suitable for large and complex systems, in which the maintenance phases require the simultaneous entry of several operators into the hazardous areas.

**Holding force of the unlocked actuator**

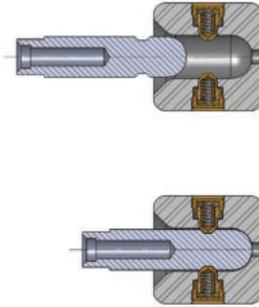

A version of the lock out device with 100 N holding force is available on request. With this new optional feature, the handle is kept in its limit-stop closed position; a moderately energetic pull is required to open the door. This device is ideal for all applications where multiple doors are unlocked simultaneously but only one is actually opened; all unlocked doors are held in position, thereby preventing vibrations or gusts of wind from opening them.

**Padlocking option for protecting against errors**

The lock out device is operated by a simple rotation of the slider to expose the holes for mounting padlocks. As a result, padlocks can no longer be mounted incorrectly, since the holes are not exposed until the switch is fully locked. 12 holes for padlocks with a diameter of 7 mm are present.

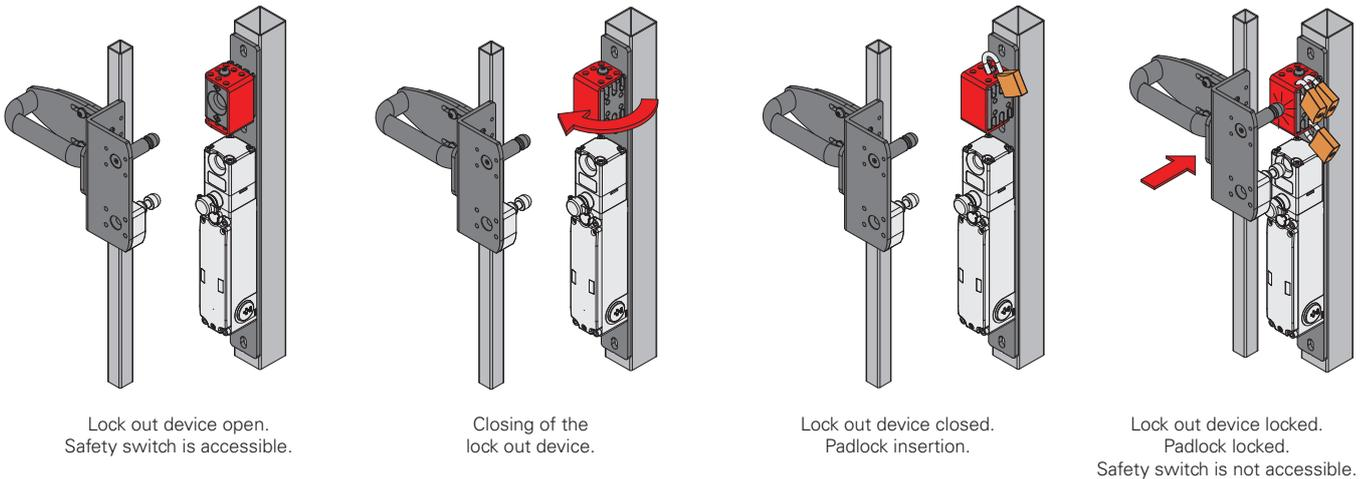

**Turnable centring block**

The special configuration allows the use of the lock out device on hinged and sliding doors, both right and left, changing only the mounting position.

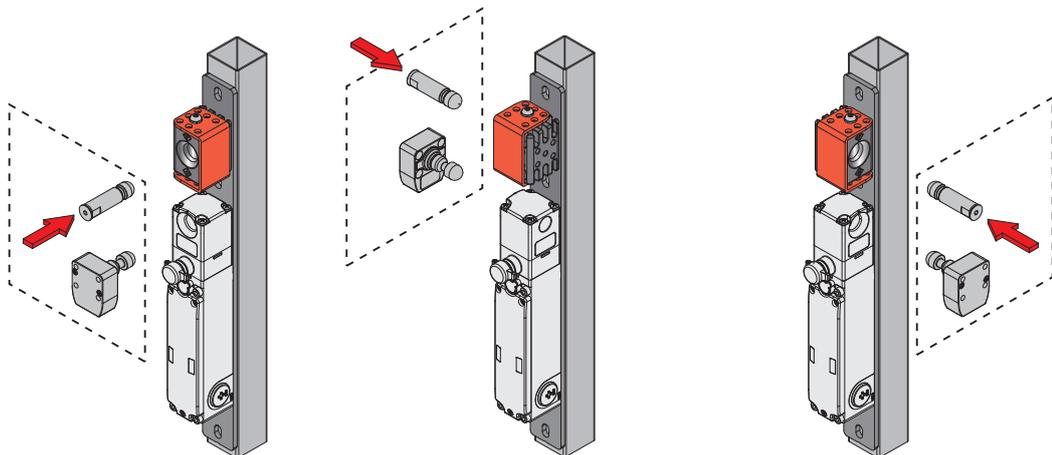

## Code structure

**Attention!** The feasibility of a code number does not mean the effective availability of a product. Please contact our sales office.

## AP G2C-800P

LOCK OUT device	
0	Centering block only
1	LOCK OUT device
2	LOCK OUT device with 100 N holding force

Grip	
P	plastic grip
M	metal grip

Note: the handle is supplied with fastening screws for the grip, for the switch, and for bolting the plates together.

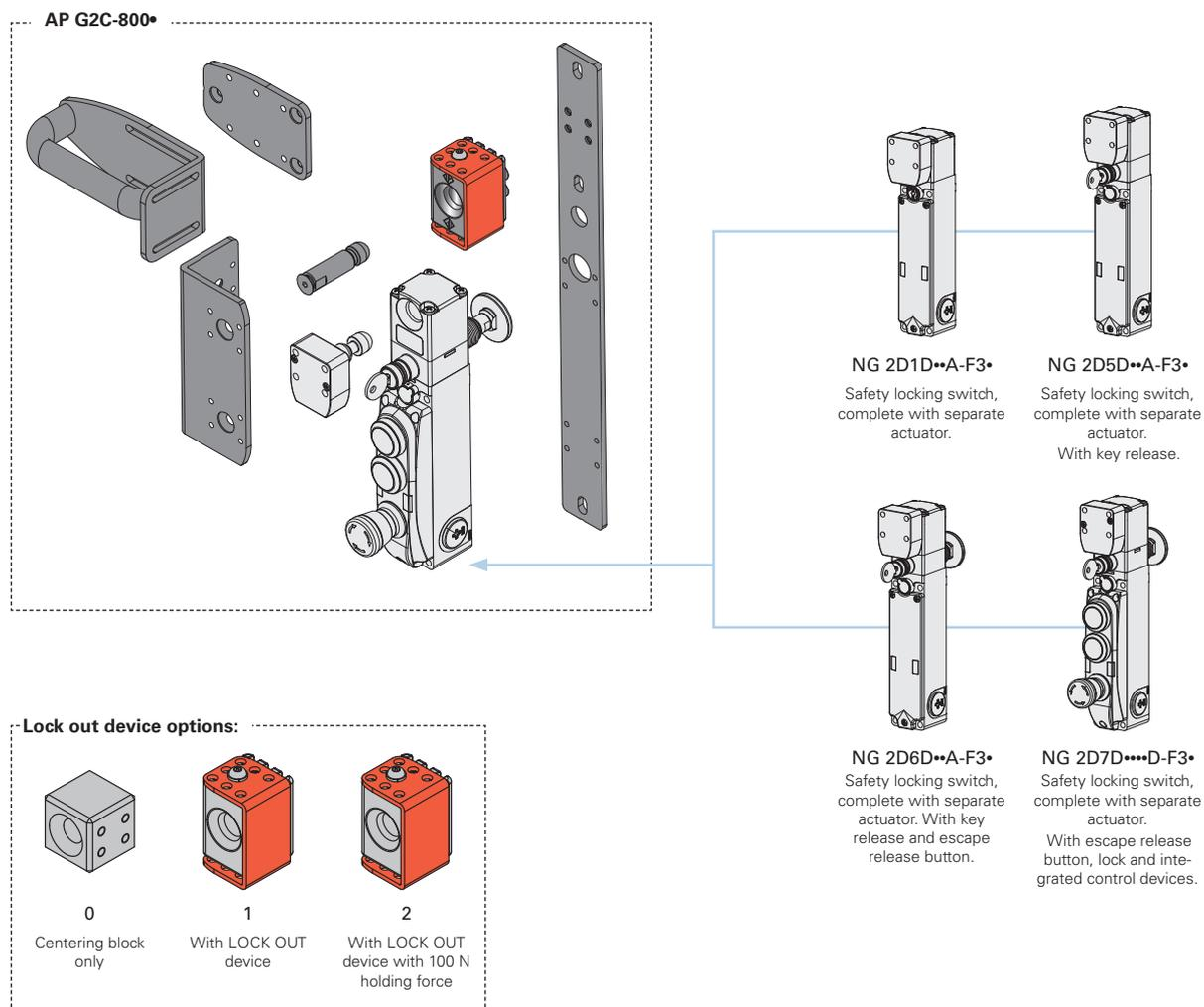

→ sold separately as accessory

The NG series safety switch is also available in other versions. For further information see page 131.

## Dimensional drawings

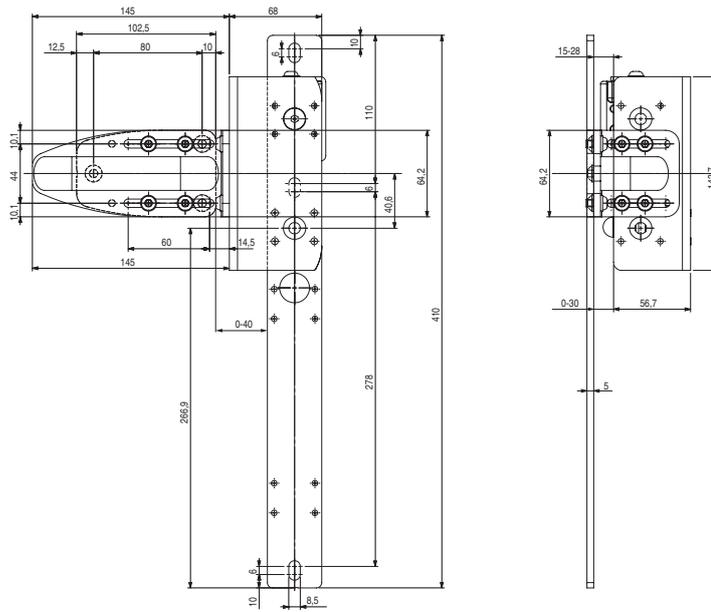

## Accessories

### Extensions for release button

Article	Description	Drawing
VN NG-LP30	Metal extension for release button. For max. wall thickness of 30 mm	
VN NG-LP40	Metal extension for release button. For max. wall thickness of 40 mm	
VN NG-LP50	Metal extension for release button. For max. wall thickness of 50 mm	
VN NG-LP60	Metal extension for release button. For max. wall thickness of 60 mm	
VN NG-ERB	Red metal release button	

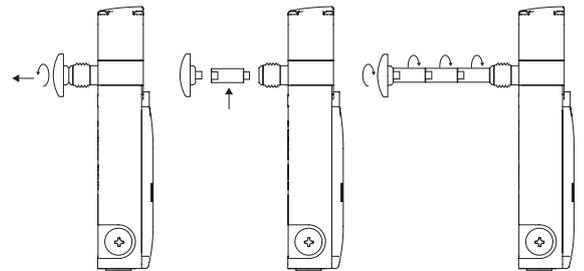

- Metal extensions can be combined with one another to achieve the desired length.
- Do not exceed an overall length of 500 mm between the release button and the switch.
- Use medium-strength thread locker to secure the extensions.

### Adhesive labels for escape release button



Polycarbonate yellow adhesive, rectangular, 300 x 32 mm, red inscription. It has to be fixed on the internal part of the jamb and helps finding the escape release button.

Article	Description and language	
VF AP-A1AGR01	PREMERE PER USCIRE	ita
VF AP-A1AGR02	PUSH TO EXIT	eng
VF AP-A1AGR04	ZUM ÖFFNEN DRÜCKEN	deu
VF AP-A1AGR05	POUSSER POUR SORTIR	fra
VF AP-A1AGR06	PULSAR PARA SALIR	spa
VF AP-A1AGR07	НАЖАТЬ ДЛЯ ВЫХОДА	rus
VF AP-A1AGR08	NACISNAĆ ABY WYJŚĆ	pol
VF AP-A1AGR09	PRESSIONAR PARA SAIR	por

### Bits for safety screws

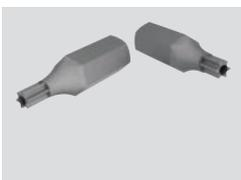

Bits for safety screws with pin, with 1/4" hexagonal connection.

Article	Description
VF VAIT1T25	Bits for M5 screws with Torx T25 fitting
VF VAIT1T30	Bits for M6 screws with Torx T30 fitting

## Description



Pizzato Elettrica is revolutionising the concept of safety handles, with the launch of the new **P-KUBE Krome** series to the market.

These products combine the characteristics of a robust handle for safety enclosures, with an ergonomic, rounded grip and customisable functions for the customer, with various illuminated signalling options, to reflect the state of the guard, or other operating conditions the manufacturer wishes to indicate. The new handles also allow integration of a control device (e.g. a button), directly in the grip.

The new safety handles are a built-in and innovative solution for machine manufacturers who, with a single product and wiring harness, can optimise the cost of components, by eliminating peripheral control boxes and illuminated signalling columns, and implementing aesthetically pleasing and exclusive guards – without compromising on the quality and reliability offered by Pizzato products.

## Integrated control device

In the grip of the P-KUBE Krome handle, a spring-return button with 1NO contact can be integrated. This can be illuminated with a LED, and thus allows interaction with the machinery; for example to request guard opening, or transmit a reset command. The button is available in white, red, green, yellow, blue, and black.



## Robustness

The internal fixing plate is made of painted steel, and 5 mm thick, to ensure locking system robustness, and increased service life.

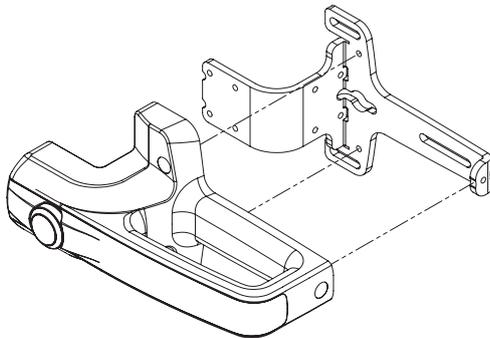

## Adaptability and flexibility

The same handle can be used on both hinged and sliding doors, with opening both on the right and on the left, simply by fixing the actuator on different levels.

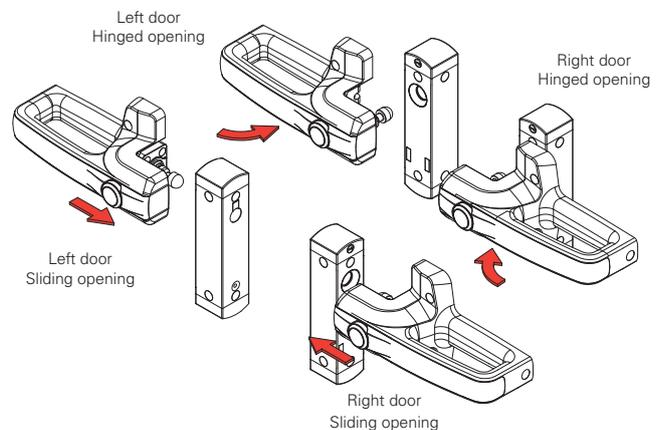

## Protection against tampering

The P-KUBE Krome handle is supplied complete with snap-on protection caps to be applied to the holes of the fixing screws, so as to prevent access: therefore, standard screws can be used instead of tamper-proof screws, ensuring safety against deliberate tampering on the device. The caps also prevent the accumulation of soiling and facilitate the cleaning of the handle.

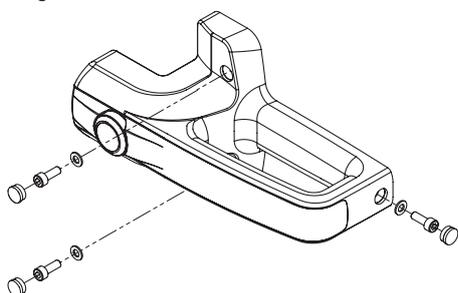

## Chrome-plated or illuminated grip

The grip is available with front strip in two finishes: satin chrome, and illuminated white. In the second version, the grip can be illuminated using RGB LED technology.

The modern, ergonomic design, combined with fully concealed fixing screws and wiring, allows implementation of machines and guards with particularly pleasing aesthetics.



**Available versions**

Thanks to the wide range of configurations available, the P-KUBE Krome safety handle can be ordered in the version that best suits the user's needs. Customization options apply to the handle, which can be supplied with or without a control device, or with or without RGB LED lighting. This feature allows you to find the most suitable product for a specific application or to diversify the handles that are installed on the same system, depending on the needs of machine designers and installers.



**Customisable multicoloured illumination**

The P-KUBE Krome handle, with illuminated grip, allows the machine manufacturer to locally signal the state of the guard by using various colours, and fully customisable sequences. Thanks to RGB LED technology, the handle illumination is visible from a large distance; even in brightly-lit environments. The device illuminates in colours: green, yellow, red, blue, white, purple, light blue.

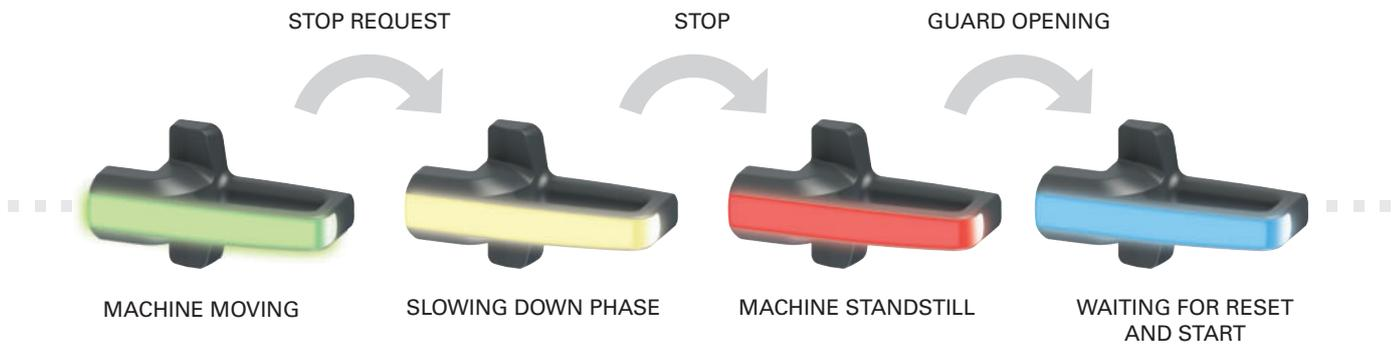

**Connections**

The electrical connections are made through a cable that comes out at the back of the device and can therefore be easily housed inside the frame of the guard, so as to make it completely invisible. This feature has a double advantage: contributing to the aesthetics of the machine and ensuring the protection of the cable against damage and tampering.

The P-KUBE Krome handle is available with PVC cable connections or with cable and integrated M12 connector.



Selection diagram

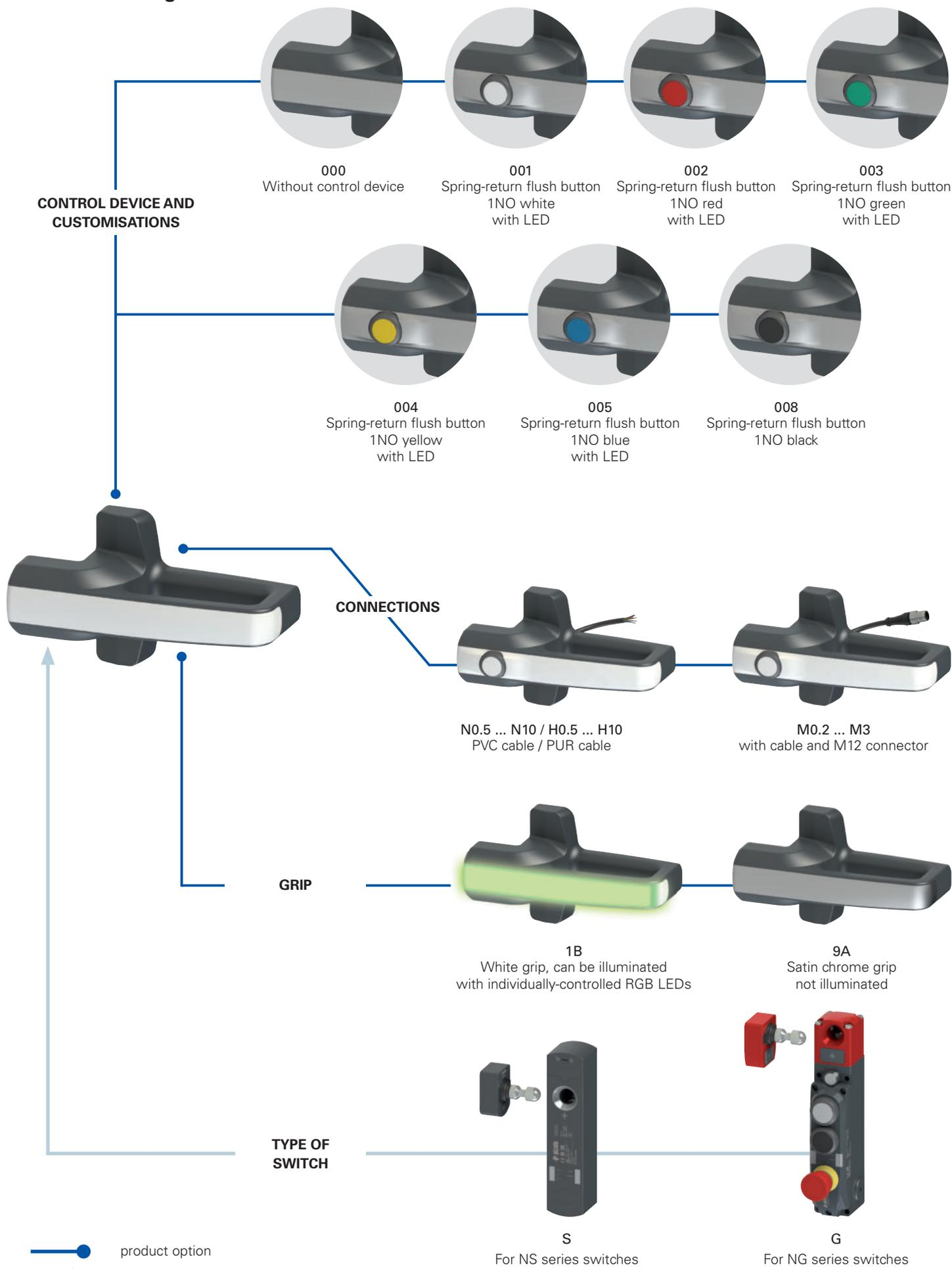



**Code structure**

**Attention!** The feasibility of a code number does not mean the effective availability of a product. Please contact our sales office

article
options  
**AN S1B000A-PN3**

Device type	
<b>S</b>	For NS series switches
<b>G</b>	For NG series switches

Note: the switches and their actuators must be purchased separately.

Grip	
<b>1B</b>	White grip, can be illuminated with multicolor RGB LEDs supply voltage 24 Vdc
<b>9A</b>	Satin chrome grip not illuminated

Control device and customisations	
<b>000</b>	Without control device
<b>001</b>	Spring-return flush button 1NO white with LED
<b>002</b>	Spring-return flush button 1NO red with LED
<b>003</b>	Spring-return flush button 1NO green with LED
<b>004</b>	Spring-return flush button 1NO yellow with LED
<b>005</b>	Spring-return flush button 1NO blue with LED
<b>008</b>	Spring-return flush button 1NO black

1NO+1NC, 2NC or 2NO contacts available on request.  
Other control devices on request, see page 143.

Cable type and connection	
<b>M0.2</b>	PVC cable, IEC 60332-1-2 oil resistant, length 0.2 m and M12 connector (standard)
<b>M0.5</b>	PVC cable, IEC 60332-1-2 oil resistant, length 0.5 m and M12 connector
...	...
<b>M3</b>	PVC cable, IEC 60332-1-2 oil resistant, length 3 m and M12 connector
<b>N0.5</b>	PVC cable, IEC 60332-1-2 oil resistant, length 0.5 m
...	...
<b>N3</b>	PVC cable, IEC 60332-1-2 oil resistant, length 3 m (standard)
...	...
<b>N10</b>	PVC cable, IEC 60332-1-2 oil resistant, length 10 m
<b>H0.5</b>	PUR cable, halogen free, length 0.5 m
...	...
<b>H3</b>	PUR cable, halogen free, length 3 m (standard)
...	...
<b>H10</b>	PUR cable, halogen free, length 10 m

Output direction, connections	
<b>P</b>	rear output

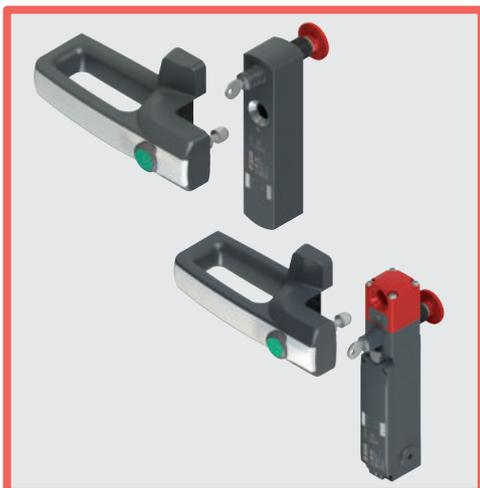

## Main features

- Modern and ergonomic design
- Versions with integrated RGB LEDs, for local signalling of guard state
- Customisable multicoloured illumination
- Illuminated control button integrated into grip
- Grip with different finishes
- Compatible with NG and NS series safety locking switches with RFID technology

## Quality marks:



UL approval: E131787  
EAC approval: RU C-IT.YT03.B.00035/19

## Technical data

### Materials

Internal fixing plate in steel, oven-cured powder-coated.  
Glass fibre reinforced technopolymer grip, self-extinguishing and shock-proof.

### Electrical cables

Integrated mobile installation cable 8 x 0.25 mm<sup>2</sup> or 5 x 0.25 mm<sup>2</sup>.  
Versions with 3 m integrated cable, other lengths 0.5 to 10 m on request.  
Versions with 0.2 m cable and M12 connector, other lengths 0.2 to 3 m on request.

### General data

Protection degree	
Versions with control device:	IP65 acc. to EN 60529
Versions without control device:	IP67 acc. to EN 60529 IP69K acc. to ISO 20653
Ambient temperature:	-20 ... +50°C
Storage temperature:	-40 ... +75°C
Mission time:	20 years

### Power supply electrical data

Rated operating voltage $U_e$ :	24 Vdc $\pm$ 15%
Operating current at $U_e$ voltage:	75 mA max
External protection fuse:	1 A type Gg or equivalent device

### Electrical data of RGB LED control inputs

Rated operating voltage $U_{e1}$ :	24 Vdc
Operating current at $U_{e1}$ voltage:	5 mA
RGB LED life:	min. 100,000 hours at rated voltage and +25 °C ambient temperature

### Technical data of the control devices

Mechanical endurance:	1 million operating cycles
Actuating force:	4 N min, 100 N max
Contact material:	silver contacts
Contact design:	Self-cleaning contacts with double interruption
Thermal current $I_{th2}$ :	1 A
Rated insulation voltage $U_{i2}$ :	32 Vac/dc
Rated impulse withstand voltage $U_{imp2}$ :	1.5 kV
LED supply voltage:	24 Vdc $\pm$ 15%
Single LED supply current:	10 mA
Utilization category of the contact block:	DC13; $U_{e2}$ =24 Vdc, $I_{e2}$ =0.55 A

### In compliance with standards:

For articles with integrated electrical parts:  
IEC 60947-5-1, EN 60947-5-1, IEC 60947-1, EN 60947-1, IEC 60529, EN 60529,  
EN IEC 63000, UL 508, CSA 22.2 N. 14.

### Compliance with the requirements of:

For articles with integrated electrical parts:  
Low Voltage Directive 2014/35/EU,  
EMC Directive 2014/30/EU.  
For all products:  
RoHS Directive 2011/65/EU.



**Electrical connections**

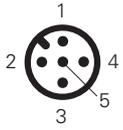

Versions with button  
articles AN 9A

Pin	Cable colour	Connection
1	brown	Supply to white button LED +24 Vdc
2	white	Supply to white button LED 0 V
3	blue	Disconnected
4	black	Button NO contact
5	grey	Button NO contact

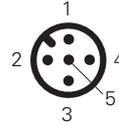

Versions with illuminated grip  
articles AN 1B000

Pin	Cable colour	Connection
1	brown	Supply input +24 Vdc
2	white	Supply input +0 Vdc
3	blue	Control input blue (B) +24 Vdc
4	black	Control input red (R) +24 Vdc
5	grey	Control input green (G) +24 Vdc

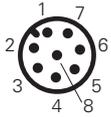

Versions with button and illuminated grip  
articles AN 1B

Pin	Cable colour	Connection
1	white	Supply input +0 Vdc
2	brown	Supply input +24 Vdc
3	green	Control input green (G) +24 Vdc
4	yellow	LED power supply for button lighting +24 Vdc
5	grey	Button NO contact
6	pink	Button NO contact
7	blue	Control input blue (B) +24 Vdc
8	red	Control input red (R) +24 Vdc

**LED handle lighting combinations**

R	G	B	Colour	R	G	B	Colour
0	0	0		1	1	0	
1	0	0		1	0	1	
0	1	0		0	1	1	
0	0	1		1	1	1	

0 = colour control input off, 1 = colour control input on.

**Dimensional drawings**

Internal fixing plate (articles AN S)

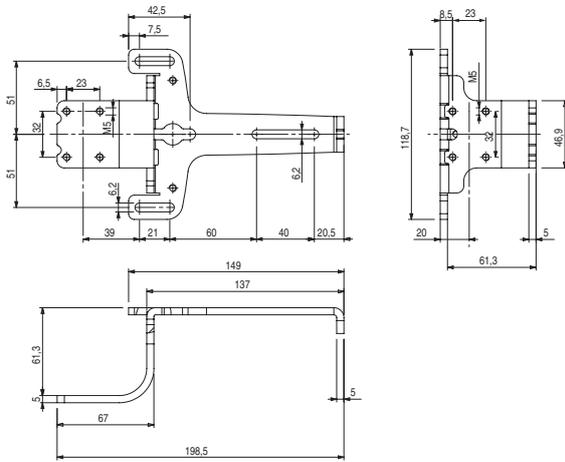

Internal fixing plate (articles AN G)

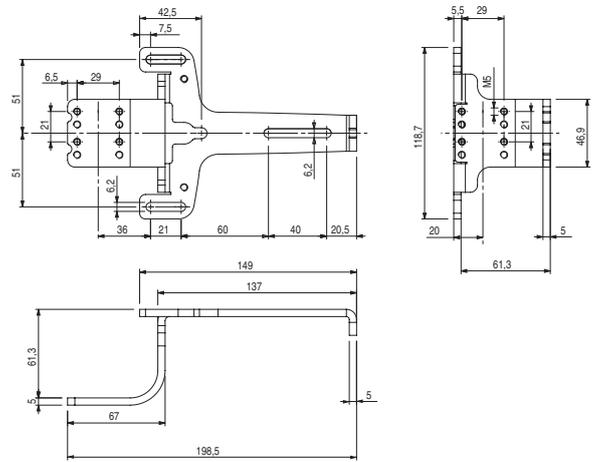

Grip

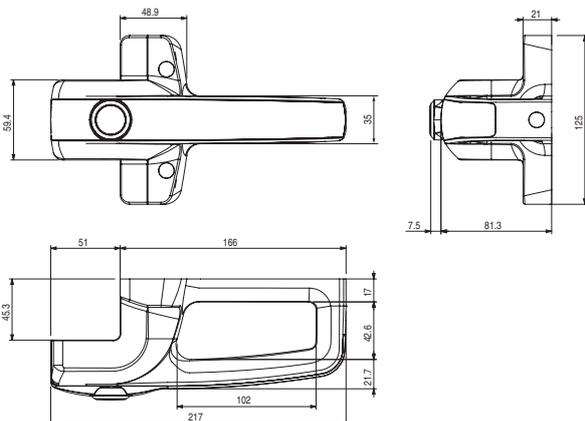

Switch-actuator alignment

Articles AN G

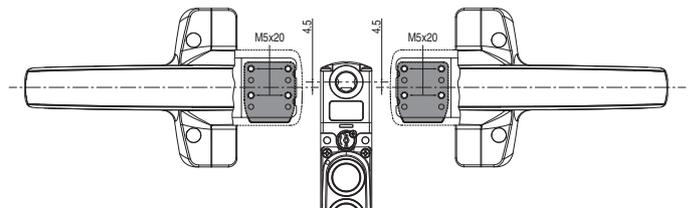

Articles AN S

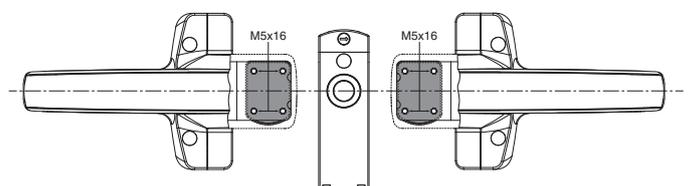

All values in the drawings are in mm

Accessories See page 321

→ The 2D and 3D files are available at [www.pizzato.com](http://www.pizzato.com)

## LK S lock out device for NS series switches

## Description



Article	Description
LK S1D001	Lock out device for NS series switches, mounting on the right side of the switch
LK S1S001	Lock out device for NS series switches, mounting on the left side of the switch

The range of P-KUBE Krome safety handles is completed by the lock out device for NS series switches with solenoid and RFID technology. The device has a full metal design and is attached laterally to the holes on the NS device, without any auxiliary fixing plate or support.

The front slider, in addition to mechanically closing the actuator entry hole, also functions as a shield for the RFID receiver antenna on the NS switch; thus ensuring an additional level of protection against accidental closure of the guard and untimely machine restart. This is particularly effective, for example, for machines with an installed low-level coded actuator, making any attempt to bypass the switch impossible.

When the slider is lifted, a  $\varnothing 7$  mm wide elongated eyelet emerges on the top of the device, allowing insertion of up to 5 padlocks.

## General data

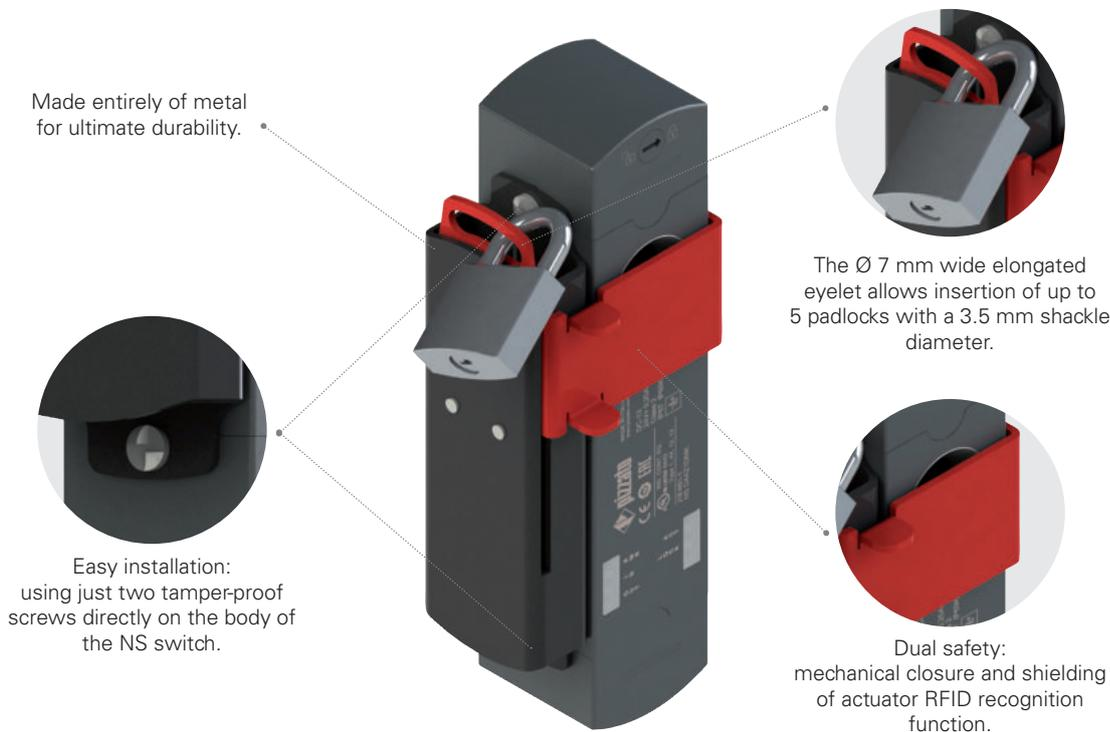

## Error-proof operation

To prevent unintentional guard closure, simply move the red door upwards so that the actuator entry hole is fully covered, and the pin cannot be inserted.

Before entering the danger zone, each operator must insert his or her own personal padlock in the lock out slot. This means that the lock out device can be unlocked only once all padlocks have been removed; i.e., once all operators have exited the danger zone.

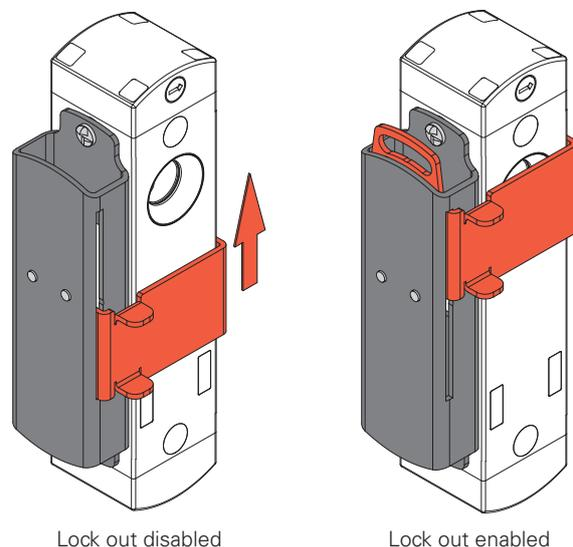

### Maximum adaptability and compatibility

The precise engineering of the LK S lock out device has enabled implementation of a highly versatile product, able to easily adapt to all potential configurations of guards on which an NS series switch is used.

The unique shape of the slider that seals the actuator hole allows the LK S lock out device to be used on both hinged and sliding guards, on both left and right.

The lock out and interlock switch are designed and manufactured for ideal compatibility with the new P-KUBE Krome handles by Pizzato Elettrica; allowing implementation of robust and functional protection systems, with an innovative aesthetic impact.

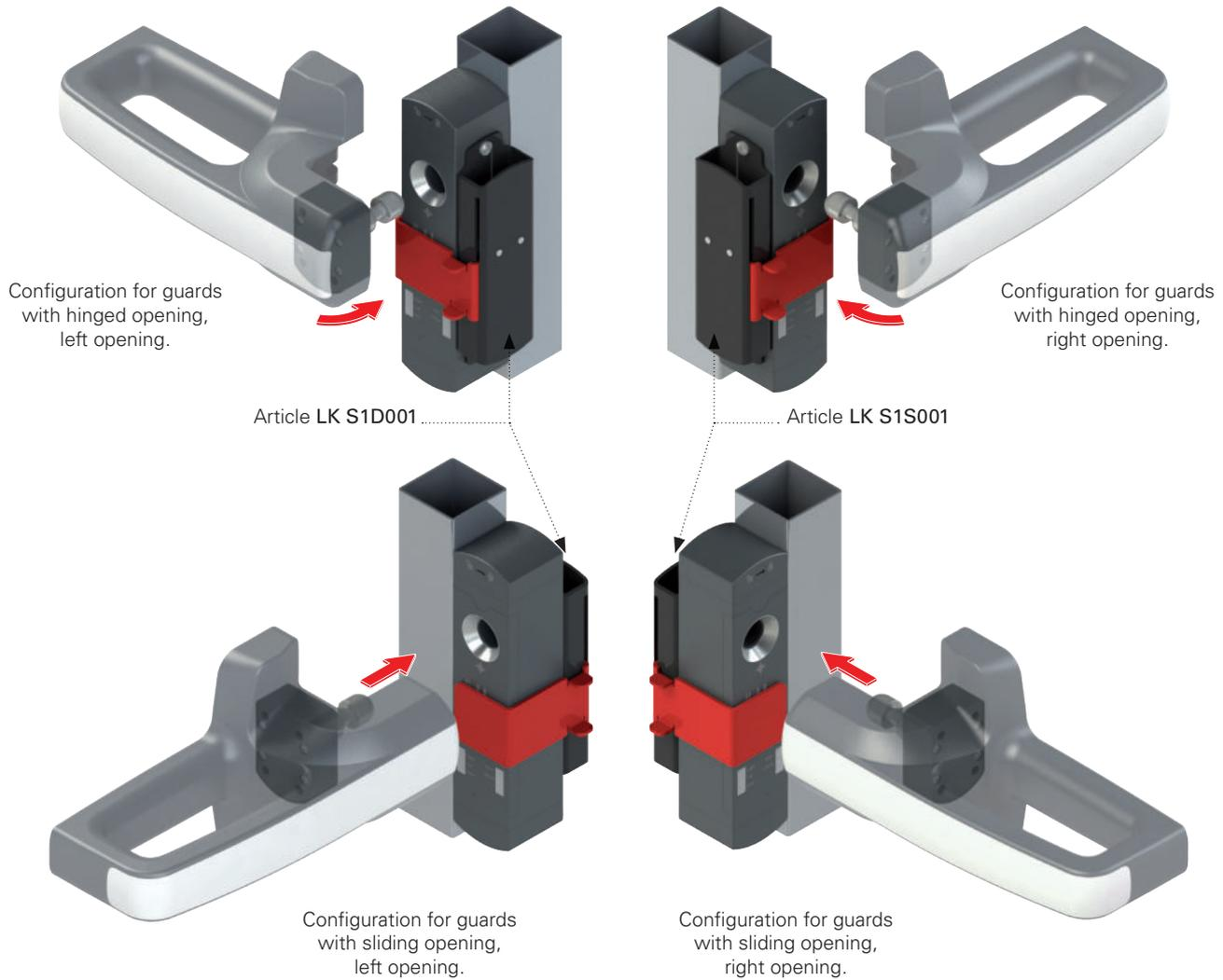

### Dimensional drawings

Article LK S1S001

Article LK S1D001

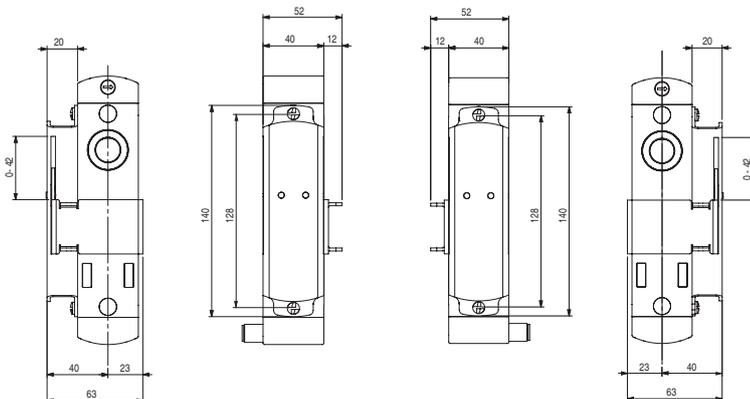

All values in the drawings are in mm

Accessories See page 321

→ The 2D and 3D files are available at [www.pizzato.com](http://www.pizzato.com)

## AP G1Z-000Z lock out device for NG series switches

## Description



Article	Description
AP G1Z-000Z	Lock out device for NG series switches

Lock out device made entirely of metal to be installed with NG series switches with solenoid and RFID technology, compatible with the P KUBE 2 and P KUBE Krome series safety handles.

To prevent unintentional guard closure, simply move the black slider down so that the actuator entry hole is fully covered. When the slider is lowered, a plate with  $\varnothing 7$  mm holes emerges on the top of the device, allowing insertion of up to 9 padlocks.

The slider also serves as a shield for the RFID receiver antenna on the NG switch.

## General data

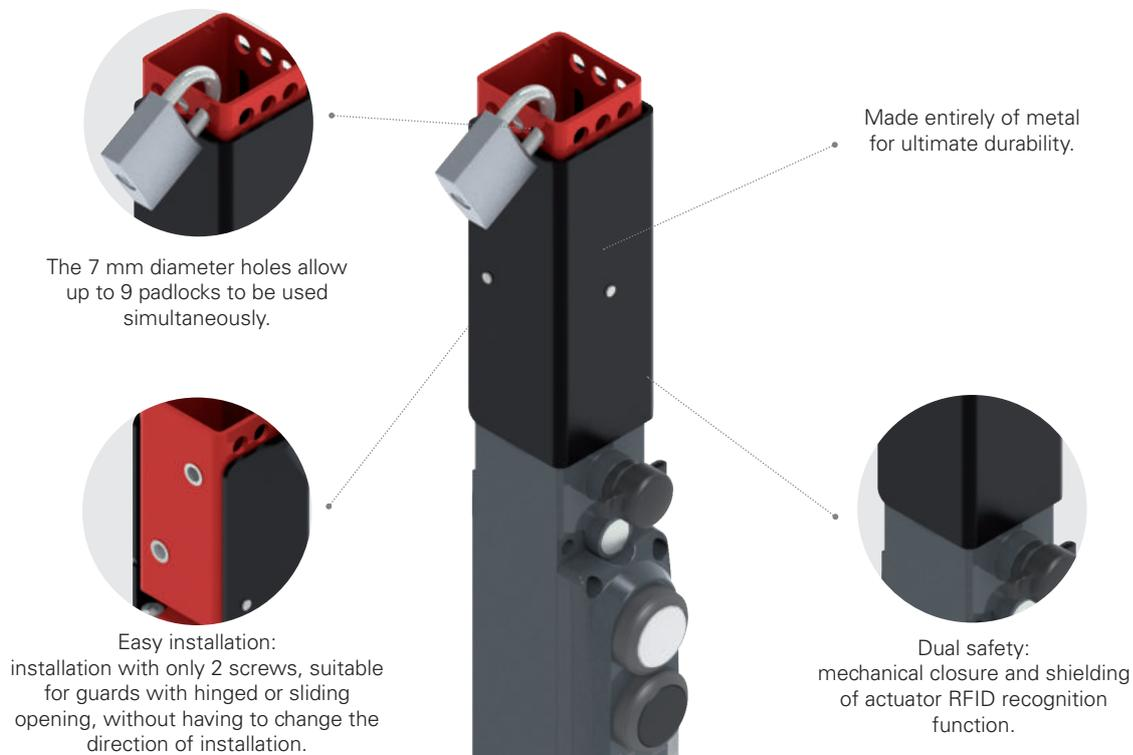

## Error-proof operation

With a single operation, the lock out device can close the centring hole in the NG switch as well as shield the RFID recognition system for detecting the actuator. Accidental closing of the guard is thereby prevented by inhibiting both the mechanical locking of the door and the electrical switching of the switch contacts.

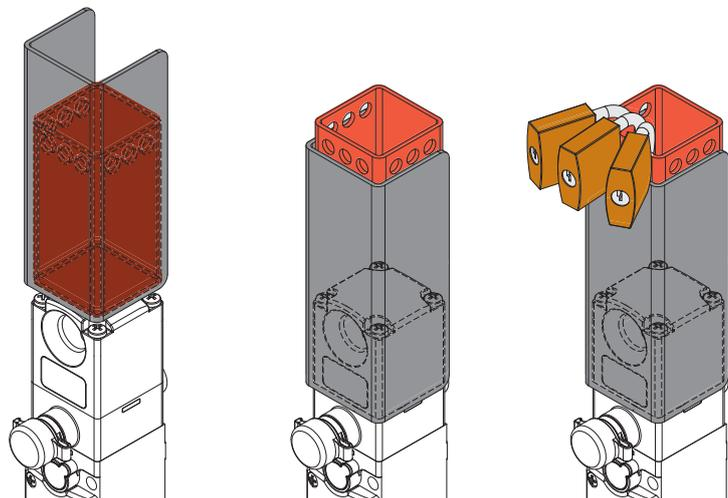

### Maximum adaptability and compatibility

The symmetry of the AP G1Z-000Z lock out device allows it to be used in all possible configurations of guards on which a switch of the NG series is used, without any type of adaptation and any modification to the mounting position.

The unique shape of the slider that seals the actuator hole allows the AP G1Z-000Z lock out device to be used on both hinged and sliding guards, on both left and right.

The lock out and interlock switch are designed and manufactured for ideal compatibility with the new P-KUBE Krome handles by Pizzato Elettrica; allowing implementation of robust and functional protection systems, with an innovative aesthetic impact.

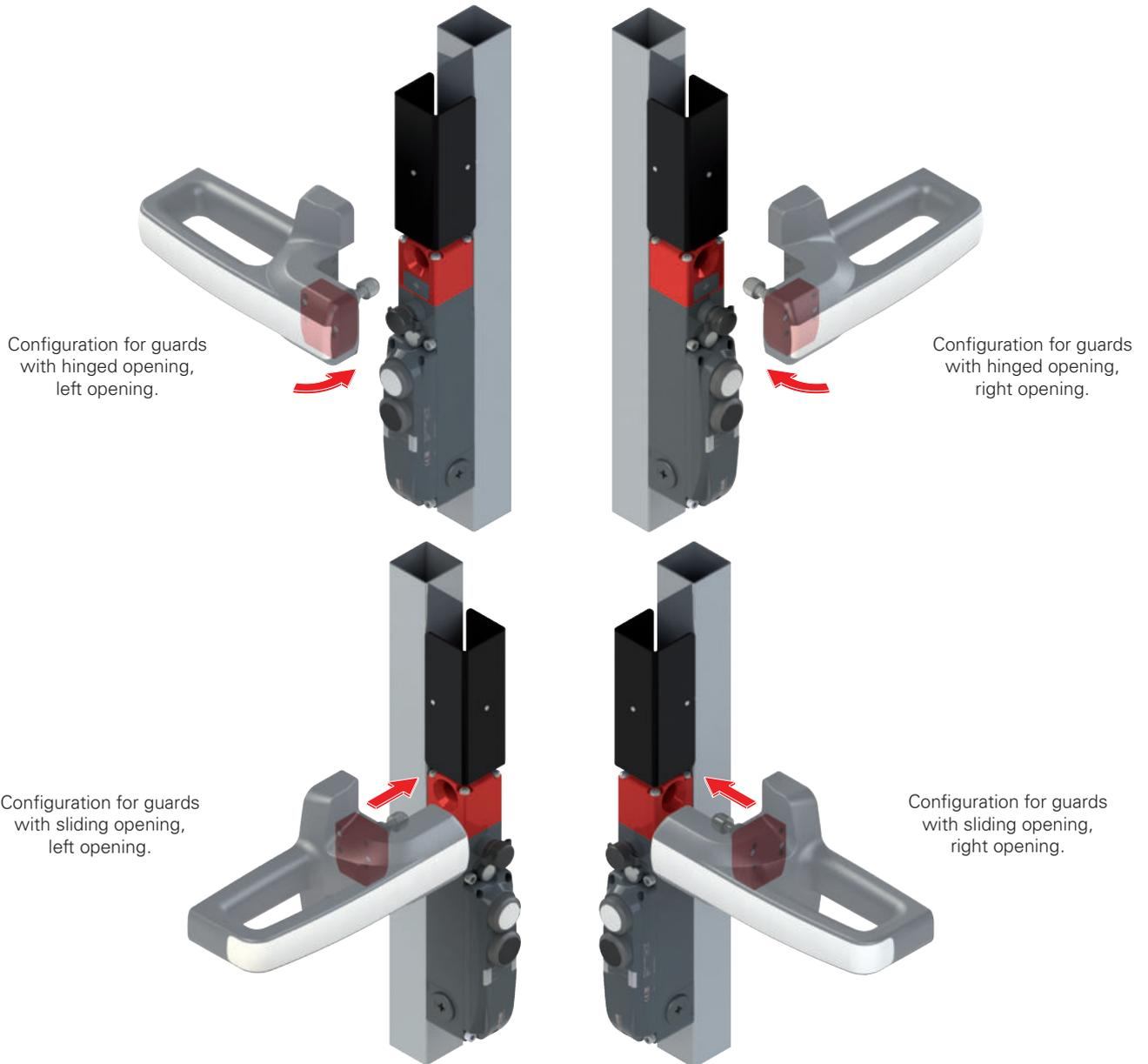

### Dimensional drawings

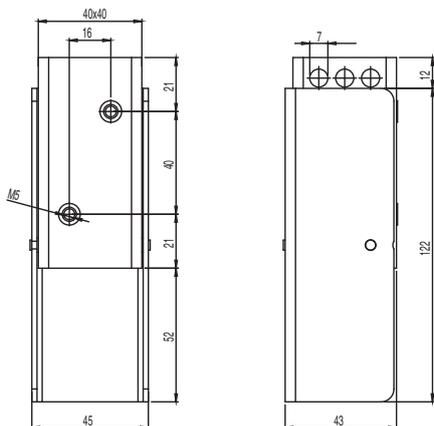

All values in the drawings are in mm

Accessories See page 321

→ The 2D and 3D files are available at [www.pizzato.com](http://www.pizzato.com)

## Description



The rope switches from Pizzato Elettrica are the result of many years of experience and cooperation with major industrial machine manufacturers. The products can be used in nearly all industrial applications, including many niche solutions. The product range includes solutions for general start/stop applications as well as for emergency stop switches. The emergency-stop rope switches were the first on the market to satisfy the requirements of EN ISO 13850 with patented solutions in a small size. The range of products offered by Pizzato Elettrica is complemented with appropriate accessories for safe and long-term use, even under difficult environmental conditions. Among the latest product innovations, the fastening and tensioning systems of the "FAST" line are worth mentioning (patented). At the focus of this development was the fast installation and an attractive design that blends harmoniously into the flowing designs of current machine generations.

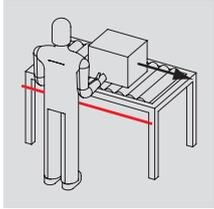

Conveyors

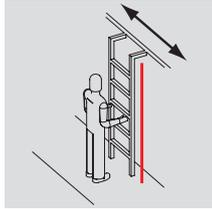

Sliding ladders

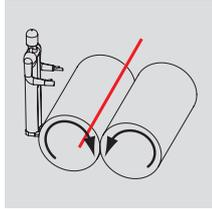

Rollers

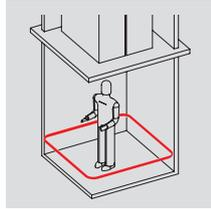

Lift compartment

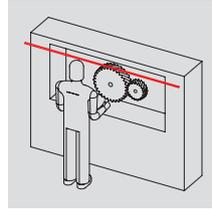

Long bay machinery

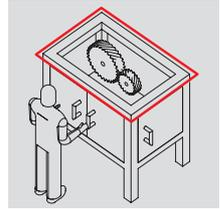

Complete perimeter protection

Rope switches are used to give different types of commands.

- **For stop commands**, rope switches with positive opening at medium rope tension are used; this also allows damage to the rope to be detected.
- **For emergency stop**, rope switches with positive opening in accordance with EN ISO 13850 are used. Here, the mechanical reset system opens the contact independent of the actuation speed of the rope, upon both actuation as well as breakage of the rope. With these switches, the reset system must be manually reset after each intervention.

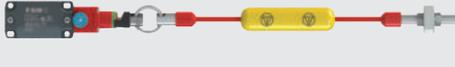
	Requirements	Colours	How to install:
<b>Stop commands</b>  example: FD 1879-M2	Positive opening is required (⊕)	Black is the colour suggested by standards for stop operations.	 The rope should be tensioned so as to enable detection of any breaks or stretching of the rope
<b>Emergency stops</b>  example: FD 1878-M2	Positive opening is required (⊕) Compliance with EN ISO 13850 is required	For emergency stops red rope is compulsory. A yellow background is recommended (see function indicator).	 The rope must be tensioned so as to enable detection of any breaks or stretching of the rope

## Detection of an actuated or cut rope

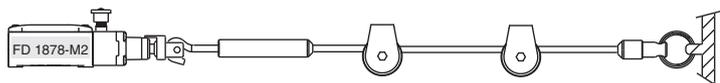

Rope correctly mounted and in resting position, electric contacts closed.

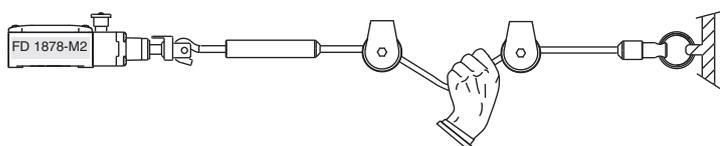

Rope pulled by operator, electric contacts open.

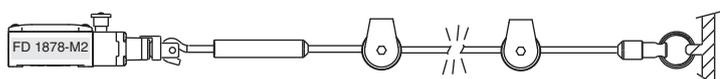

Rope cut, electric contacts open.

## Accessories for rope locking and tightening, "FAST" system

Pizzato Elettrica has developed and patented special accessories for more quickly installing the ropes of safety switches and at the same time creating a more aesthetically pleasing system.

Compared to the traditional fixing method, the new accessories offer the following advantages:

- The installation is faster because only one screw is used for the fastening of every rope extremity, and the parts are designed to ease the installation. Practical tests have shown that the installation time is reduced by over half, hence the name: "FAST".
- The system is aesthetically pleasant, because thread parts (which sometimes tear operators' dresses) and the rope extremities, usually fixed by heat-shrinkable sheath or adhesive tape, have been hidden.
- The rope is fixed without kinking and, as a result, does not stretch over time; re-calibration of the rope tension is no longer necessary.

The system has been tested for correct function only if used with steel ropes of high quality like the ones Pizzato Elettrica supplies.



## Rope function indicator

These function indicators help in the visualization of the rope and its emergency function highlighting its presence as recommended by the standard EN ISO 13850 chap. 4.5.1 and 4.4.5.

They are fixed on the rope through screws and thanks to their handle-shape make the operation easier. The indicators can be supplied with different texts in several languages.



## LED signalling light



It is sometimes important to have an indicator that is visible on-site to indicate which rope switch has been actuated. The high luminosity LED signalling lights from Pizzato Elettrica were developed for this purpose and can be installed directly on the threaded cable glands of the switches. These signalling lights are robust and designed in protection degrees IP67 and IP69K. The inner part of the signalling light can rotate in such a way that it can be wired without any risk of kinking the wires. They are available for power supplies of 24 Vac/dc, 120 Vac and 230 Vac and can be delivered in red, green, yellow and white. Rope switches with three contacts facilitate the realisation of systems in which each switch has two NC contacts with positive opening for the safety chain and one NO contact for the signalling light.

For more details see page 312.

## Safety springs

For some applications, ropes are needed for covering especially long spans. With day/night changes of temperature, the ropes are lengthened or shortened in proportion to the rope length, to the change of temperature and to the coefficient of expansion of the steel. The changes of the rope length do not have linear repercussions on the switch, because the very long ropes are regularly sustained by supports that modify the linearity of the system. With safety switches, the rope must be under tension within an operating tension range.

As a result, an undesired actuation of the safety switch is possible with very long ropes or in the case of very high temperature differences. To reduce the effect of the changes of the temperature, it is possible to install a safety spring at the opposite extremity of the switch, so the rope elongation is equally divided between the two devices. The safety spring has been made to have an elastic coefficient equal to the spring inside the switch. In addition, the safety spring is equipped with a fixed ring that fully transfers the tensile force to the switch.



## Stainless steel rope pulleys



The pulleys in stainless steel are used in applications where the rope is rather long, to support its length or bend its route. The two available pulleys are robust and dimensioned so as not to deform and to securely hold the rope in the guide even if the rope is pulled energetically. The angular pulley is available in different designs with a slotted fixing hole. This simplifies installation and ensures that the rope retains the correct distance from guard edges.

## Safety modules

The rope safety switches inserted in the emergency chains can be connected with the Pizzato Elettrica safety modules in order to obtain safety circuits up to PL e in accordance with EN ISO 13849. Safety modules with instantaneous and delayed contacts are available for the realization of emergency circuits type 0 (immediate stop) or type 1 (monitored stop).

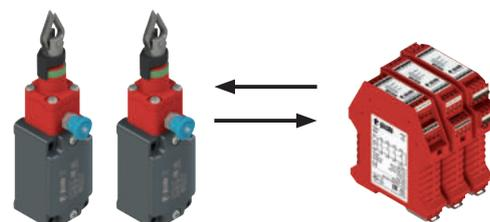

Selection diagram

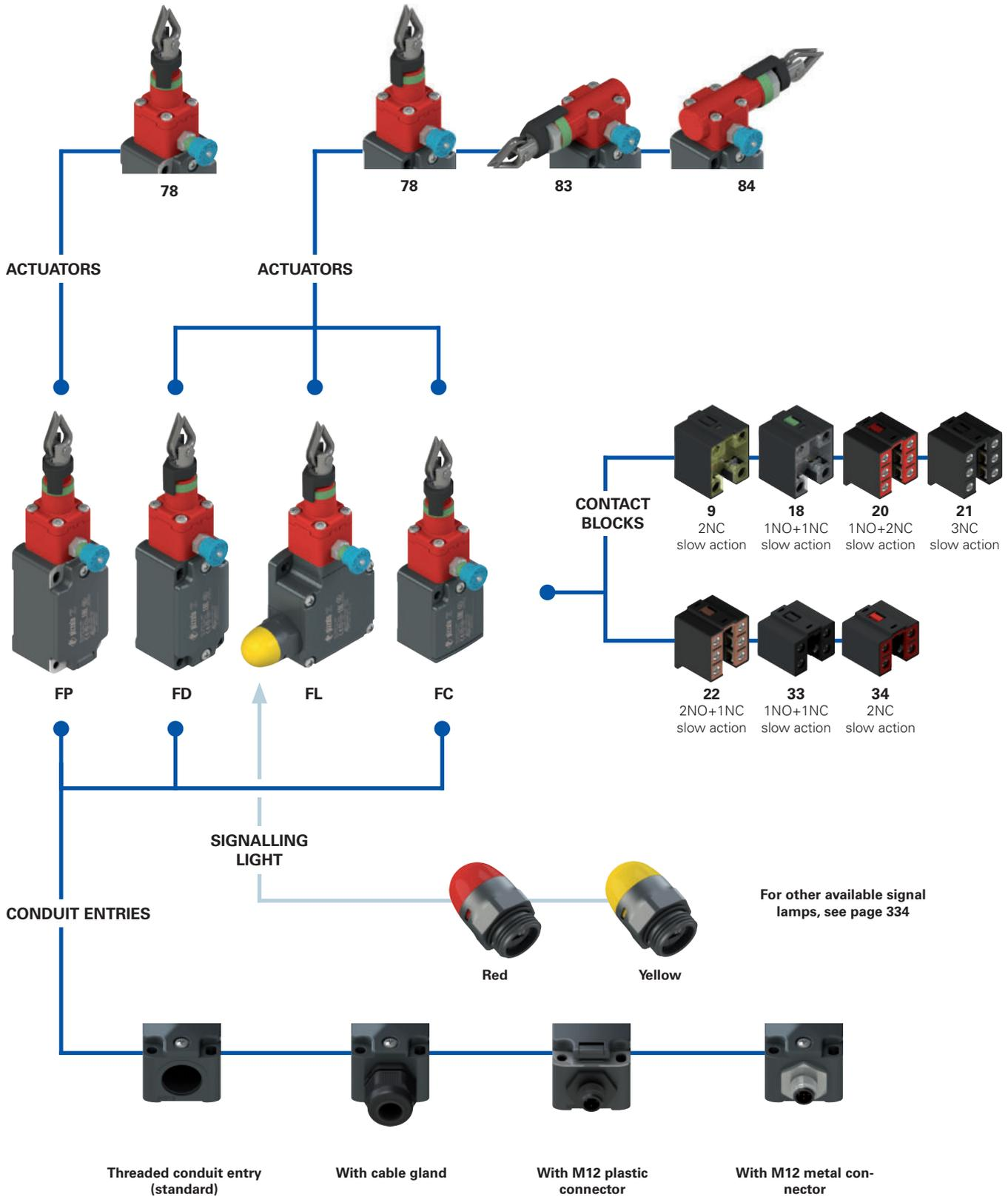

—●— product options  
 —→— sold separately as accessory



**Code structure****Attention!** The feasibility of a code number does not mean the effective availability of a product. Please contact our sales office.

article
options
options

**FD 1878-E7GM2K50T6**

Housing	
<b>FD</b>	metal, one conduit entry
<b>FL</b>	metal, three conduit entries
<b>FP</b>	technopolymer, one conduit entry

Contact blocks	
<b>9</b>	2NC, slow action
<b>18</b>	1NO+1NC, slow action
<b>20</b>	1NO+2NC, slow action
<b>21</b>	3NC, slow action
<b>22</b>	2NO+1NC, slow action
<b>33</b>	1NO+1NC, slow action
<b>34</b>	2NC, slow action

Actuating head	
<b>78</b>	longitudinal head
<b>83</b>	left transversal head (FD-FL housing only)
<b>84</b>	right transversal head (FD-FL housing only)

Actuating force	
	standard
<b>E7</b>	initial 20 N...final 40 N (only head 78)
<b>E9</b>	initial 13 N...final 75 N (only head 83-84)

Ambient temperature	
	-25°C ... +80°C (standard)
<b>T6</b>	-40°C ... +80°C

Pre-installed cable glands or connectors	
	no cable gland or connector (standard)
<b>K23</b>	cable gland for cables Ø 6 ... 12 mm
...	.....
<b>K50</b>	M12 metal connector, 5-pole
...	.....

For the complete list of possible combinations please contact our technical department.

Threaded conduit entry	
<b>M2</b>	M20x1.5 (standard)
	PG 13.5

Contact type	
	silver contacts (standard)
<b>G</b>	silver contacts with 1 µm gold coating
<b>G1</b>	Silver contacts, 2.5 µm gold coating (not for contact blocks 20, 21, 22, 33, 34)

article
options
options

**FC 3378-E7GM2K50T6**

Housing	
<b>FC</b>	metal, one conduit entry

Contact blocks	
<b>33</b>	1NO+1NC, slow action
<b>34</b>	2NC, slow action

Actuating head	
<b>78</b>	longitudinal head
<b>83</b>	left transversal head
<b>84</b>	right transversal head

Actuating force	
	standard
<b>E7</b>	initial 20 N...final 40 N (only head 78)
<b>E9</b>	initial 13 N...final 75 N (only head 83-84)

Ambient temperature	
	-25°C ... +80°C (standard)
<b>T6</b>	-40°C ... +80°C

Pre-installed cable glands or connectors	
	no cable gland (standard)
<b>K23</b>	cable gland for cables Ø 6 ... 12 mm
<b>K50</b>	M12 metal connector, 5-pole

Threaded conduit entry	
<b>M2</b>	M20x1.5 (standard)
	PG 11

Contact type	
	silver contacts (standard)
<b>G</b>	silver contacts with 1 µm gold coating

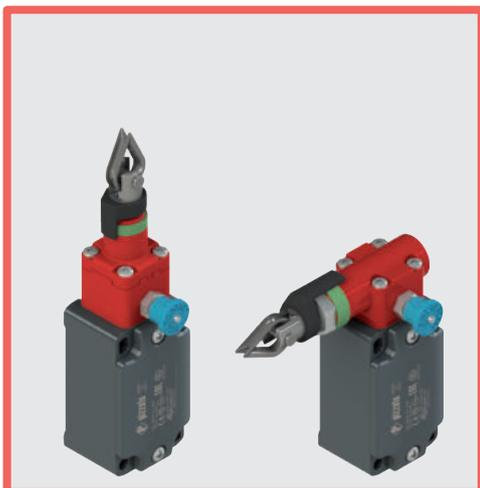

### Main features

- Metal or plastic housing, from one to three conduit entries
- Protection degree IP67
- In compliance with EN ISO 13850
- 7 contact blocks available
- Versions with vertical or horizontal actuation
- Versions with assembled M12 connector
- Versions with gold-plated silver contacts

### Quality marks:



IMQ approval:	EG605
UL approval:	E131787
CCC approval:	2007010305230000
EAC approval:	RU C-IT.YT03.B.00035/19

### Technical data

#### Housing

FP series housing made of glass fibre reinforced technopolymer, self-extinguishing, shock-proof and with double insulation:   
 FD, FL and FC series: metal housing, baked powder coating.  
 FD, FP, FC series: one threaded conduit entry: M20x1.5 (standard)  
 FL series: three threaded conduit entries: M20x1.5 (standard)  
 Protection degree: IP67 acc. to EN 60529 with cable gland of equal or higher protection degree

#### General data

SIL (SIL CL) up to:	SIL 3 acc. to EN 62061
Performance Level (PL) up to:	PL e acc. to EN ISO 13849-1
Safety parameters:	
$B_{10D}$ :	2,000,000 for NC contacts
Mission time:	20 years
Ambient temperature:	-25°C ... +80°C (standard) -40°C ... +80°C (T6 option)
Max. actuation frequency:	1 cycle / 6 s
Mechanical endurance:	1 million operating cycles
Max. actuation speed:	0.5 m/s
Min. actuation speed:	1 mm/s
Tightening torques for installation:	see page 339
Wire cross-sections and wire stripping lengths:	see page 357

#### In compliance with standards:

IEC 60947-5-1, IEC 60947-1, IEC 60204-1, EN ISO 14119, EN ISO 12100, IEC 60529, EN ISO 13850, EN 418, EN 50581, UL 508, CSA 22.2 No.14.

#### Approvals:

EN 60947-5-1, UL 508, CSA 22.2 No.14, GB/T14048.5-2017.

#### Compliance with the requirements of:

Machinery Directive 2006/42/EC, EMC Directive 2014/30/EU, RoHS Directive 2011/65/EU.

#### Positive contact opening in conformity with standards:

IEC 60947-5-1, EN 60947-5-1.

**⚠ If not expressly indicated in this chapter, for correct installation and utilization of all articles see the instructions given on pages 337 to 350.**

	Electrical data	Utilization category
without connector	Thermal current ( $I_{th}$ ):	10 A
	Rated insulation voltage (U):	500 Vac 600 Vdc 400 Vac 500 Vdc (contact blocks 20, 21, 22, 33, 34)
	Rated impulse withstand voltage ( $U_{imp}$ ):	6 kV 4 kV (contact blocks 20, 21, 22, 33, 34)
	Conditional short circuit current: Protection against short circuits: Pollution degree:	1000 A acc. to EN 60947-5-1 type aM fuse 10 A 500 V 3
with M12 connector, 4 and 5-pole	Thermal current ( $I_{th}$ ):	4 A
	Rated insulation voltage (U):	250 Vac 300 Vdc
	Protection against short circuits: Pollution degree:	type gG fuse 4 A 500 V 3
with M12 connector, 8-pole	Thermal current ( $I_{th}$ ):	2 A
	Rated insulation voltage (U):	30 Vac 36 Vdc
	Protection against short circuits: Pollution degree:	type gG fuse 2 A 500 V 3



## Description



These rope-operated safety switches are installed on machines or conveyor belts and allow the machine to be brought to an emergency stop from any point and with any pull on the rope. This means significant cost savings for medium and large machines, since multiple emergency-stop buttons can be replaced with a single switch. They are equipped with a self-control function that constantly checks the correct function and signals a possible loosening or breaking of the rope through the opening of the contacts. These safety switches keep the contacts open after activation until the reset is performed, even if the rope is released.

## Head with variable orientation

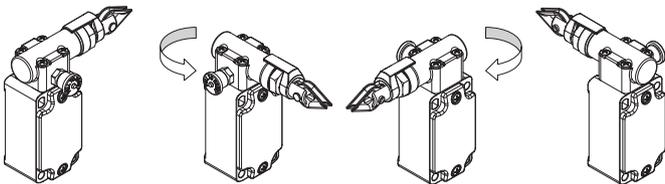

For all switches, the head can be adjusted in 90° steps after removing the four fastening screws.

## Extended temperature range

# -40°C

These devices are also available in a special version suitable for an ambient operating temperature range from -40°C up to +80°C.

They can therefore be used for applications in cold stores, sterilisers and other equipment with low temperature environments. The special materials used to produce these versions retain their characteristics even under these conditions, thereby expanding the installation possibilities.

## Indicator for rope adjustment

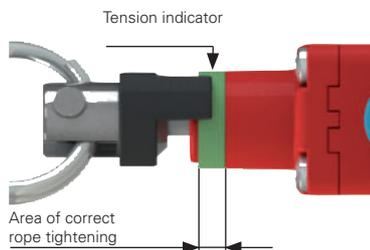

All switches are provided with a green ring that shows the area of the correct tightening of the rope. The installer has only to tighten the rope until the black indicator will be in the middle of the green area. With this setting, the switch can be reset by pulling the blue knob to close the electrical safety

contacts.

If the tension (or loosening) on the rope is so high that the black indicator exits the green area, the electrical safety contacts will open and the reset device will trigger.

## Features approved by IMQ

Rated insulation voltage (Ui):	500 Vac 400 Vac (for contact blocks 20, 21, 22, 33, 34)
Conventional free air thermal current (Ith):	10 A
Protection against short circuits:	type aM fuse 10 A 500 V
Rated impulse withstand voltage (Uimp):	6 kV 4 kV (for contact blocks 20, 21, 22, 33, 34)
Protection degree of the housing:	IP67
MV terminals (screw terminals)	
Pollution degree:	3
Utilization category:	AC15
Operating voltage (Ue):	400 Vac (50 Hz)
Operating current (Ie):	3 A

Forms of the contact element: Zb, Y+Y, Y+Y+X, Y+Y+Y, Y+X+X  
Positive opening contacts on contact blocks 9, 18, 20, 21, 22, 33, 34  
In compliance with standards: EN 60947-1, EN 60947-5-1, fundamental requirements of the Low Voltage Directive 2014/35/EU.

Please contact our technical department for the list of approved products.

## Laser engraving



All devices are marked using a dedicated indelible laser system. These engravings are therefore suitable for extreme environments too. Thanks to this system that does not use labels, the loss of plate data is prevented and a greater resistance of the marking is achieved over time.

## Protection degree IP67

# IP67

These devices are designed to be used in the toughest environmental conditions and they pass the IP67 immersion test acc. to EN 60529. They can therefore be used in all environments where maximum protection degree of the housing is required.

## Reduced actuating force

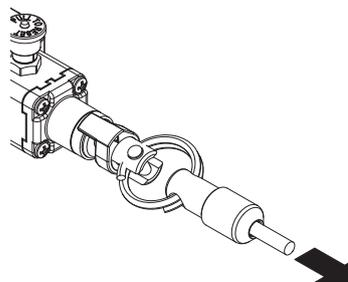

These switches can be supplied with reduced hardness internal springs on request. The force required to actuate the switch can thereby be reduced without changing the actuating path of the electrical contacts. This is particularly advantageous for smaller spans, but must, however, always make use of rope pulleys.

## Indicator for the state of the reset

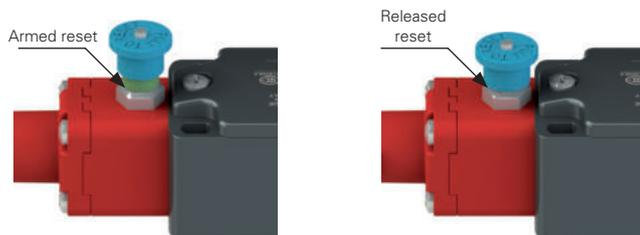

If the tension indicator is in the green area, the electrical safety contacts can be closed by pulling the blue knob. The reset status can be identified quickly by the green ring under the blue knob.

## Features approved by UL

Electrical Ratings:	Q300 pilot duty (69 VA, 125-250 V dc) A600 pilot duty (720 VA, 120-600 V ac)
Environmental Ratings:	Types 1, 4X, 12, 13
	Use 60 or 75°C copper (Cu) conductor and wire size range 12, 14 AWG, stranded or solid.
	The terminal tightening torque of 7.1 lb in (0.8 Nm).
	For FP series: the hub is to be connected to the conduit before the hub is connected to the enclosure.

Please contact our technical department for the list of approved products.

# Safety rope switches with reset for emergency stop

Contact type:

**L** = slow action

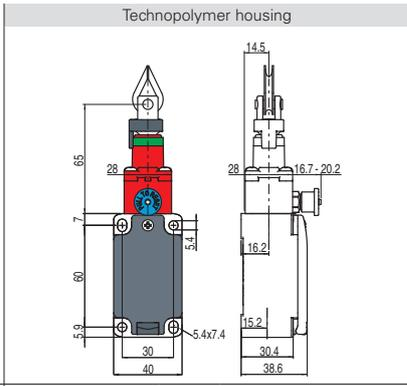

Contact blocks

9	<b>L</b>	FP 978-M2	↔	2NC
18	<b>L</b>	FP 1878-M2	↔	1NO+1NC
20	<b>L</b>	FP 2078-M2	↔	1NO+2NC
21	<b>L</b>	FP 2178-M2	↔	3NC
22	<b>L</b>	FP 2278-M2	↔	2NO+1NC
33	<b>L</b>	FP 3378-M2	↔	1NO+1NC
34	<b>L</b>	FP 3478-M2	↔	2NC
Actuating force		Initial 63 N ... final 83 N (90 N ⊕)		
Travel diagrams		Page 196 - group 1		

Contact type:

**L** = slow action

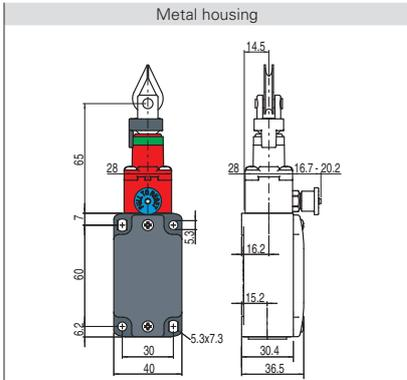

Contact blocks

9	<b>L</b>	FD 978-M2	↔	2NC
18	<b>L</b>	FD 1878-M2	↔	1NO+1NC
20	<b>L</b>	FD 2078-M2	↔	1NO+2NC
21	<b>L</b>	FD 2178-M2	↔	3NC
22	<b>L</b>	FD 2278-M2	↔	2NO+1NC
33	<b>L</b>	FD 3378-M2	↔	1NO+1NC
34	<b>L</b>	FD 3478-M2	↔	2NC
Actuating force		Initial 63 N ... final 83 N (90 N ⊕)		
Travel diagrams		Page 196 - group 1		

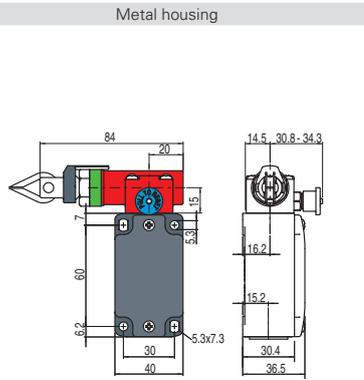

9	<b>L</b>	FD 983-M2	↔	2NC
18	<b>L</b>	FD 1883-M2	↔	1NO+1NC
20	<b>L</b>	FD 2083-M2	↔	1NO+2NC
21	<b>L</b>	FD 2183-M2	↔	3NC
22	<b>L</b>	FD 2283-M2	↔	2NO+1NC
33	<b>L</b>	FD 3383-M2	↔	1NO+1NC
34	<b>L</b>	FD 3483-M2	↔	2NC
Actuating force		Initial 147 N ... final 235 N (250 N ⊕)		
Travel diagrams		Page 196 - group 2		

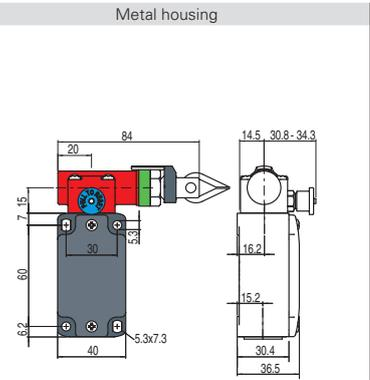

9	<b>L</b>	FD 984-M2	↔	2NC
18	<b>L</b>	FD 1884-M2	↔	1NO+1NC
20	<b>L</b>	FD 2084-M2	↔	1NO+2NC
21	<b>L</b>	FD 2184-M2	↔	3NC
22	<b>L</b>	FD 2284-M2	↔	2NO+1NC
33	<b>L</b>	FD 3384-M2	↔	1NO+1NC
34	<b>L</b>	FD 3484-M2	↔	2NC
Actuating force		Initial 147 N ... final 235 N (250 N ⊕)		
Travel diagrams		Page 196 - group 2		

Contact type:

**L** = slow action

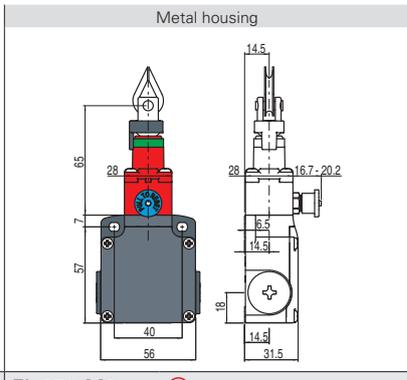

Contact blocks

9	<b>L</b>	FL 978-M2	↔	2NC
18	<b>L</b>	FL 1878-M2	↔	1NO+1NC
20	<b>L</b>	FL 2078-M2	↔	1NO+2NC
21	<b>L</b>	FL 2178-M2	↔	3NC
22	<b>L</b>	FL 2278-M2	↔	2NO+1NC
33	<b>L</b>	FL 3378-M2	↔	1NO+1NC
34	<b>L</b>	FL 3478-M2	↔	2NC
Actuating force		Initial 63 N ... final 83 N (90 N ⊕)		
Travel diagrams		Page 196 - group 1		

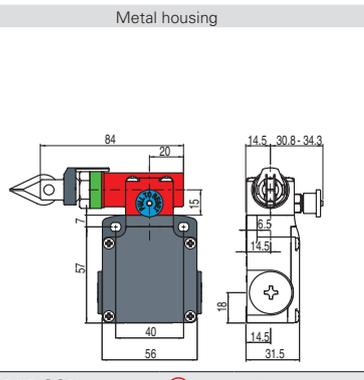

9	<b>L</b>	FL 983-M2	↔	2NC
18	<b>L</b>	FL 1883-M2	↔	1NO+1NC
20	<b>L</b>	FL 2083-M2	↔	1NO+2NC
21	<b>L</b>	FL 2183-M2	↔	3NC
22	<b>L</b>	FL 2283-M2	↔	2NO+1NC
33	<b>L</b>	FL 3383-M2	↔	1NO+1NC
34	<b>L</b>	FL 3483-M2	↔	2NC
Actuating force		Initial 147 N ... final 235 N (250 N ⊕)		
Travel diagrams		Page 196 - group 2		

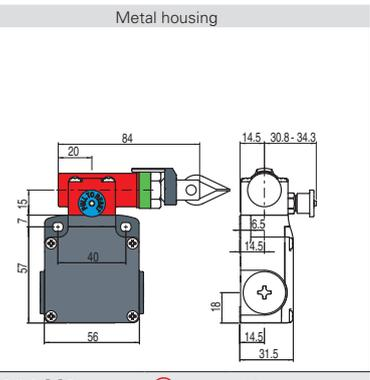

9	<b>L</b>	FL 984-M2	↔	2NC
18	<b>L</b>	FL 1884-M2	↔	1NO+1NC
20	<b>L</b>	FL 2084-M2	↔	1NO+2NC
21	<b>L</b>	FL 2184-M2	↔	3NC
22	<b>L</b>	FL 2284-M2	↔	2NO+1NC
33	<b>L</b>	FL 3384-M2	↔	1NO+1NC
34	<b>L</b>	FL 3484-M2	↔	2NC
Actuating force		Initial 147 N ... final 235 N (250 N ⊕)		
Travel diagrams		Page 196 - group 2		

All values in the drawings are in mm

Accessories See page 321

→ The 2D and 3D files are available at [www.pizzato.com](http://www.pizzato.com)



Contact type:		Metal housing	Metal housing	Metal housing
Contact type: L = slow action				
Contact blocks		33 L FC 3378-M2 1NO+1NC	FC 3383-M2 1NO+1NC	FC 3384-M2 1NO+1NC
		34 L FC 3478-M2 2NC	FC 3483-M2 2NC	FC 3484-M2 2NC
Actuating force		Initial 63 N ... final 83 N (90 N ⊕)		Initial 147 N ... final 235 N (250 N ⊕)
Travel diagrams		Page 196 - group 1		Page 196 - group 2

### How to read travel diagrams

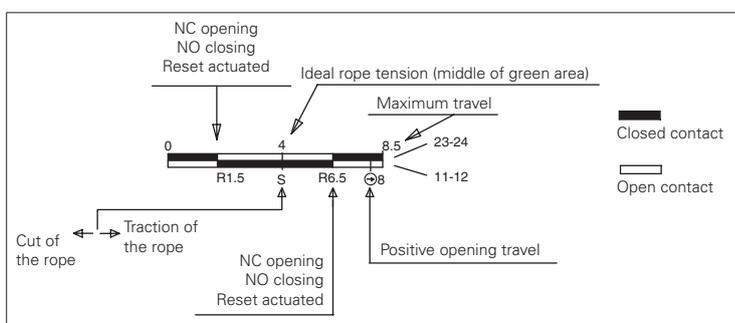

### Travel diagrams table

Contact blocks	Group 1	Group 2
9 2NC		
18 1NO+1NC		
20 1NO+2NC		
21 3NC		
22 2NO+1NC		
33 1NC+1NO		
34 2NC		

#### IMPORTANT:

In **safety applications**, actuate the switch **at least up to the positive opening travel** shown in the travel diagrams with symbol ⊕. Actuate the switch **at least with the positive opening force**, reported in brackets below each article, next to the actuating force value.

Application examples and max. rope length for switches with longitudinal head

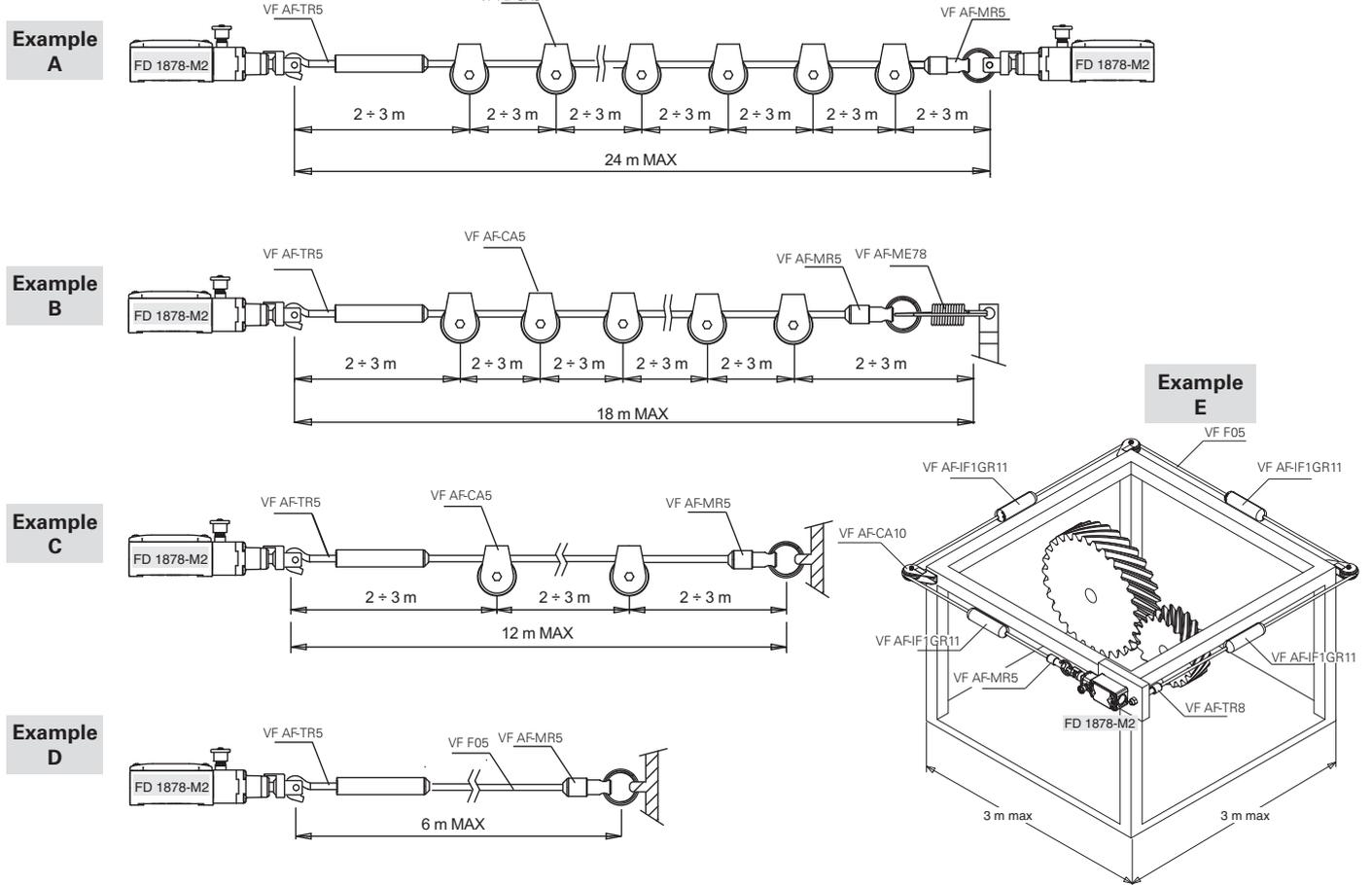

Application examples and max. rope length for switches with transversal head

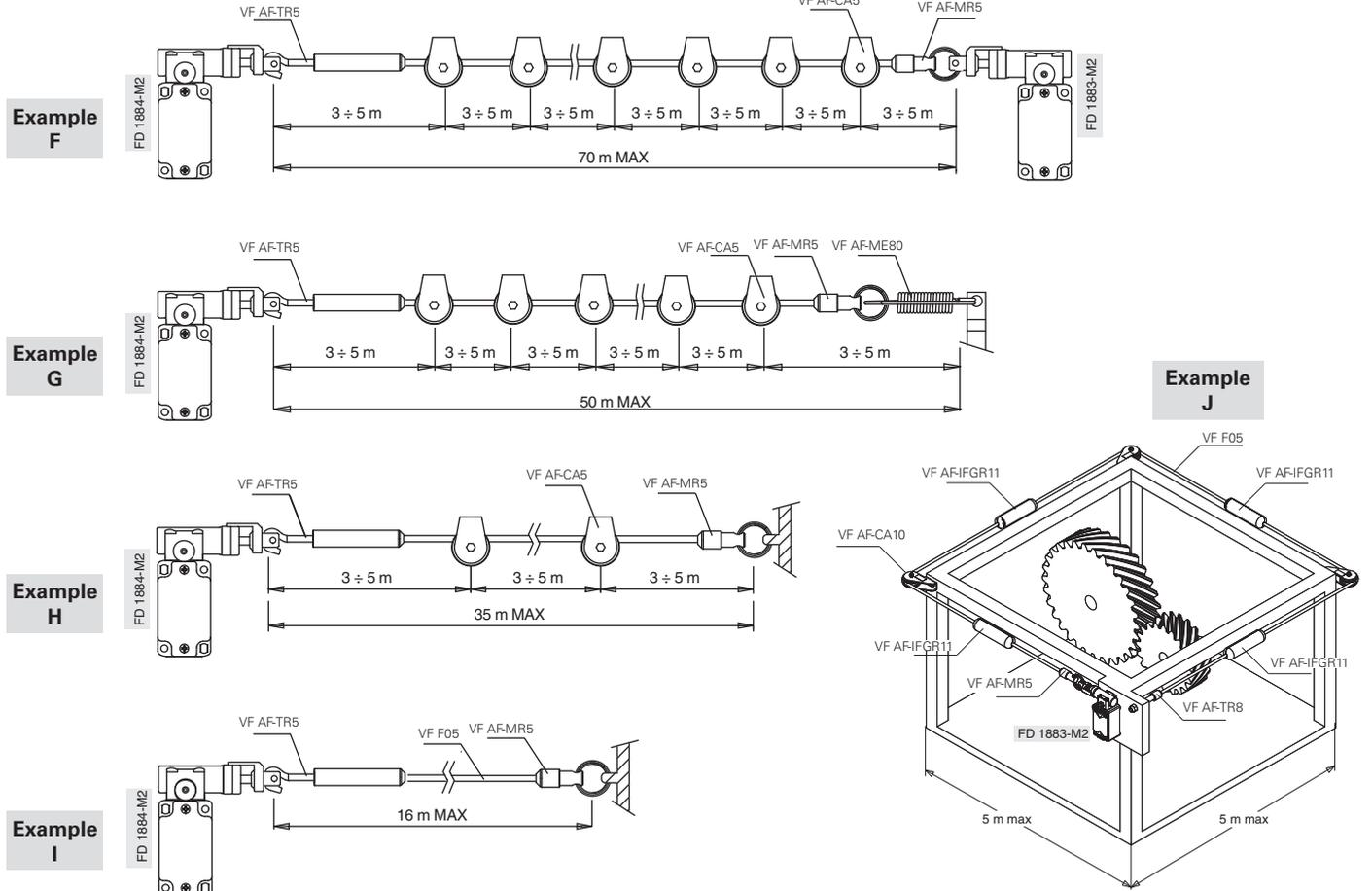



### Maximum spans

Maximum spans for switches with longitudinal head

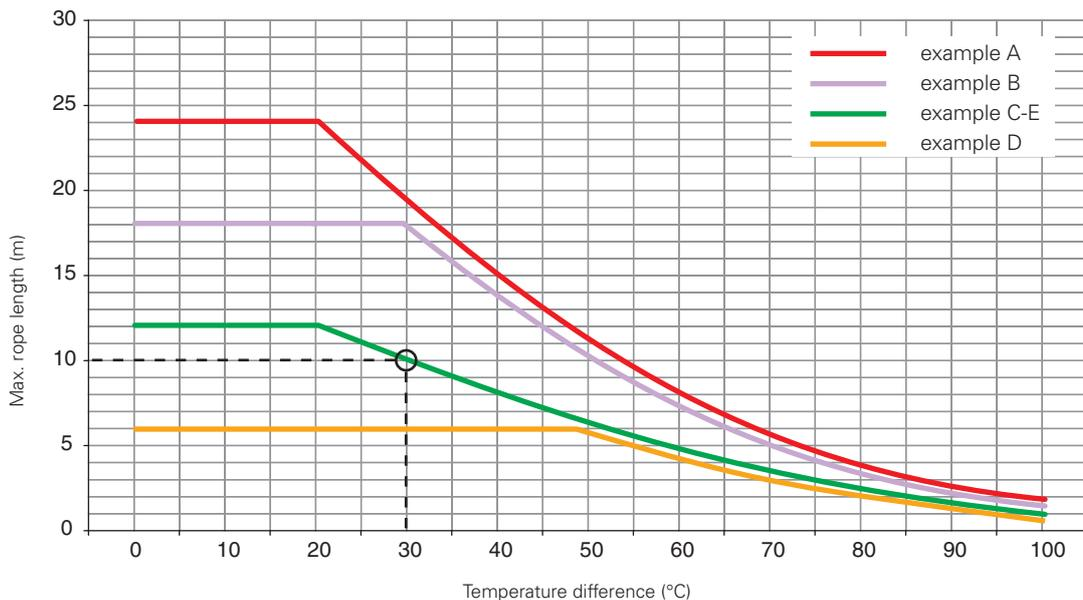

The max. recommended spans are indicated in the diagram as a function of the temperature fluctuations (temperature differences) to which the switch may be exposed at the point of use. For instance, with installation of type C and a temperature difference of 30°C, the max. recommended rope length is 10 metres.

Maximum spans for switches with transversal head

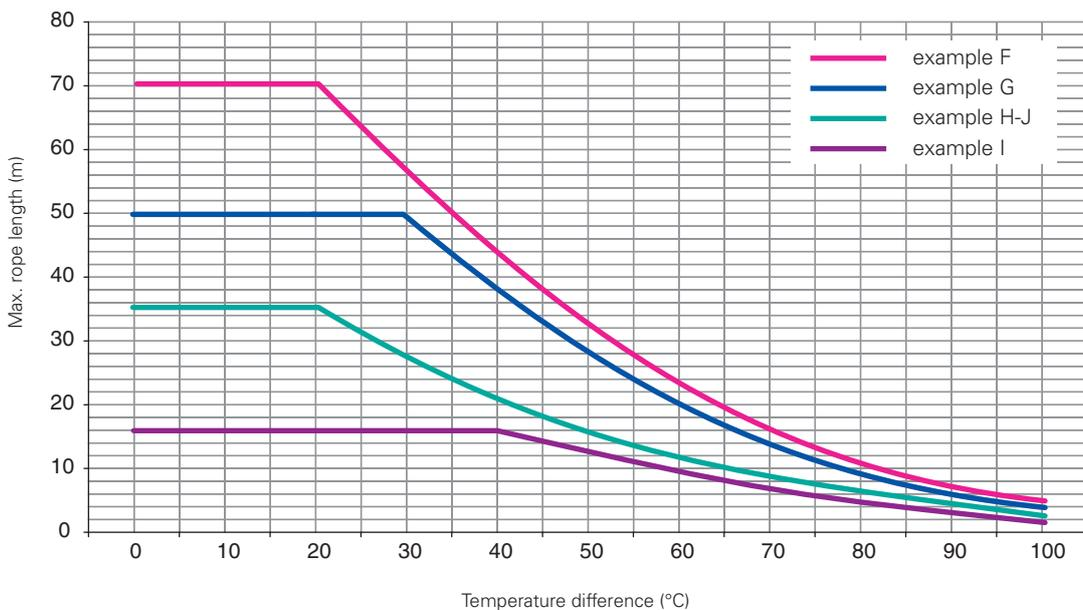

Important: The above data are guaranteed only using original rope and accessories. See page 207.

### Adjustment of the switching point

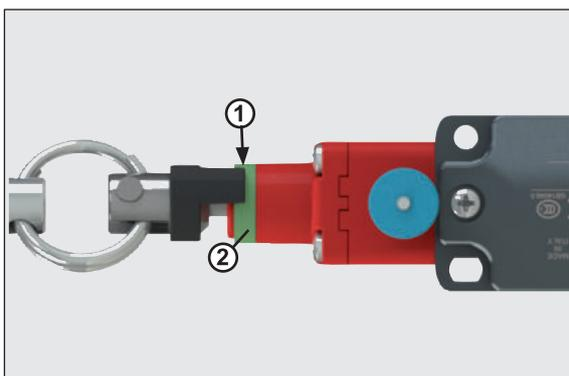

Tighten the rope connected to the switch, until the end of the indicator (1) reaches about the middle of the green ring (2).

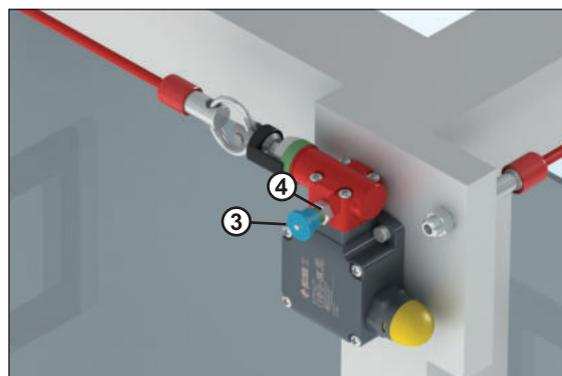

Pull the knob (3) in order to close the safety contacts inside the switch. Below the knob a green ring (4) will be disclosed.

Selection diagram

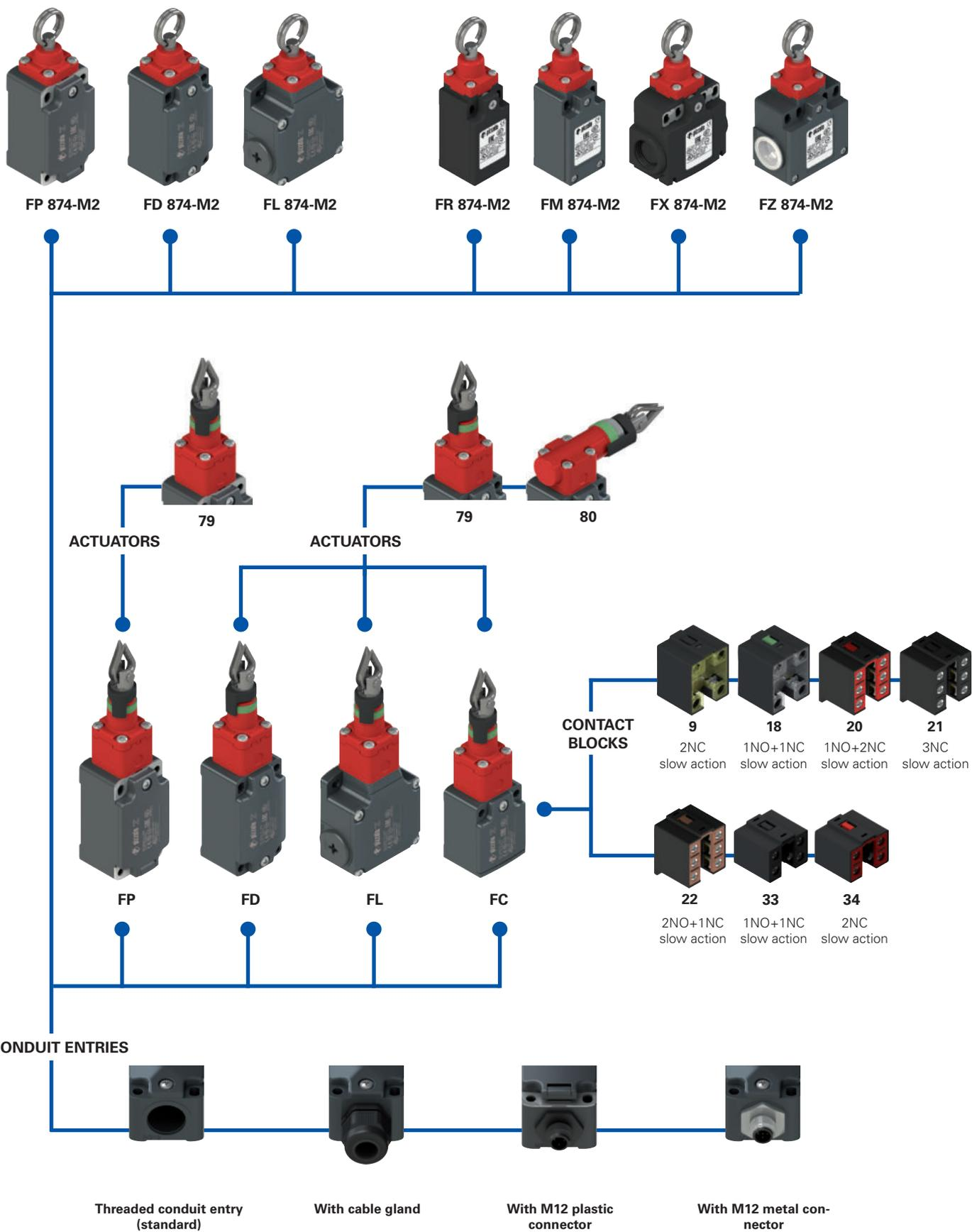

—●— product options





**Code structure** **Attention!** The feasibility of a code number does not mean the effective availability of a product. Please contact our sales office.

article options options  
**FD 1879-E7GM2K50T6**

Housing	
<b>FD</b>	metal, one conduit entry
<b>FL</b>	metal, three conduit entries
<b>FP</b>	technopolymer, one conduit entry

Ambient temperature	
	-25°C ... +80°C (standard)
<b>T6</b>	-40°C ... +80°C

Contact blocks	
<b>9</b>	2NC, slow action
<b>18</b>	1NO+1NC, slow action
<b>20</b>	1NO+2NC, slow action
<b>21</b>	3NC, slow action
<b>22</b>	2NO+1NC, slow action
<b>33</b>	1NO+1NC, slow action
<b>34</b>	2NC, slow action

Pre-installed cable glands or connectors	
	no cable gland or connector (standard)
<b>K23</b>	cable gland for cables Ø 6 ... 12 mm
...	.....
<b>K50</b>	M12 metal connector, 5-pole
...	.....

For the complete list of possible combinations please contact our technical department.

Actuating head	
<b>79</b>	longitudinal head
<b>80</b>	transversal head (FD-FL housing only)

Threaded conduit entry	
<b>M2</b>	M20x1.5 (standard)
	PG 13.5

Actuating force	
	standard
<b>E7</b>	initial 20 N...final 40 N (only head 79)
<b>E9</b>	initial 13 N...final 75 N (only head 80)

Contact type	
	silver contacts (standard)
<b>G</b>	silver contacts with 1 µm gold coating
<b>G1</b>	Silver contacts, 2.5 µm gold coating (not for contact blocks 20, 21, 22, 33, 34)

article options options  
**FC 3379-E7GM2K50T6**

Housing	
<b>FC</b>	metal, one conduit entry

Pre-installed cable glands	
	no cable gland (standard)
<b>K23</b>	cable gland for cables Ø 6 ... 12 mm
<b>K50</b>	M12 metal connector, 5-pole

Actuating head	
<b>79</b>	longitudinal head
<b>80</b>	transversal head

Actuating force	
	standard
<b>E7</b>	initial 20 N...final 40 N (only head 79)
<b>E9</b>	initial 13 N...final 75 N (only head 80)

Threaded conduit entry	
<b>M2</b>	M20x1.5 (standard)
	PG 11

Ambient temperature	
	-25°C ... +80°C (standard)
<b>T6</b>	-40°C ... +80°C

Contact type	
	silver contacts (standard)
<b>G</b>	silver contacts with 1 µm gold coating

article options options  
**FD 874-E7GM2K50T6**

Housing	
<b>FD</b>	metal, one conduit entry
<b>FL</b>	metal, three conduit entries
<b>FP</b>	technopolymer, one conduit entry
<b>FR</b>	technopolymer, one conduit entry
<b>FM</b>	metal, one conduit entry
<b>FX</b>	technopolymer, two conduit entries
<b>FZ</b>	metal, two conduit entries

Pre-installed cable glands or connectors	
	no cable gland or connector (standard)
<b>K23</b>	cable gland for cables Ø 6 ... 12 mm
...	.....
<b>K50</b>	M12 metal connector, 5-pole
...	.....

For the complete list of possible combinations please contact our technical department.

Actuating force	
	standard
<b>E7</b>	initial 20 N...final 40 N

Threaded conduit entry	
<b>M2</b>	M20x1.5 (standard)
<b>M1</b>	M16x1.5 (FR-FX housing only)
	PG 13.5
<b>A</b>	PG 11 (FR-FX housing only)

Ambient temperature	
	-25°C ... +80°C (standard)
<b>T6</b>	-40°C ... +80°C

Contact type	
	silver contacts (standard)
<b>G</b>	silver contacts with 1 µm gold coating
<b>G1</b>	silver contacts with 2.5 µm gold coating



### Main features

- Metal or plastic housing, from one to three conduit entries
- Protection degree IP67
- 7 contact blocks available
- Versions with vertical or horizontal actuation
- Versions with assembled M12 connector
- Versions with gold-plated silver contacts

### Quality marks:



IMQ approval:	EG605 (FD-FL-FP-FC series) EG610 (FR-FX-FM-FZ series)
UL approval:	E131787
CCC approval:	2007010305230000 (FD-FP-FL-FC series) 2007010305230013 (FR-FX-FM-FZ series)
EAC approval:	RU C-IT.YT03.B.00035/19

### Technical data

#### Housing

FP, FR, FX series housing made of glass fibre reinforced technopolymer, self-extinguishing, shock-proof and with double insulation: □

FD, FL, FC, FM, FZ series: metal housing, baked powder coating.

FD, FP, FC, FR, FM series: one threaded conduit entry: M20x1.5 (standard)

FX series: two knock-out threaded conduit entries: M20x1.5 (standard)

FZ series: two threaded conduit entries: M20x1.5 (standard)

FL series: three threaded conduit entries: M20x1.5 (standard)

Protection degree: IP67 acc. to EN 60529 with cable gland of equal or higher protection degree

#### General data

SIL (SIL CL) up to:	SIL 3 acc. to EN 62061
Performance Level (PL) up to:	PL e acc. to EN ISO 13849-1
Safety parameters:	
$B_{10D}$ :	2,000,000 for NC contacts
Mission time:	20 years
Ambient temperature:	-25°C ... +80°C (standard) -40°C ... +80°C (T6 option)
Max. actuation frequency:	1 cycle / 6 s
Mechanical endurance:	1 million operating cycles
Max. actuation speed:	0.5 m/s
Min. actuation speed:	1 mm/s
Tightening torques for installation:	see pages 339 and 341
Wire cross-sections and wire stripping lengths:	see page 357

#### In compliance with standards:

IEC 60947-5-1, IEC 60947-1, IEC 60204-1, EN ISO 14119, EN ISO 12100, IEC 60529, EN 50581, UL 508, CSA 22.2 No.14 .

#### Approvals:

EN 60947-5-1, UL 508, CSA 22.2 No.14, GB/T14048.5-2017.

#### Compliance with the requirements of:

Low Voltage Directive 2014/35/EU, EMC Directive 2014/30/EU, RoHS Directive 2011/65/EU.

#### Positive contact opening in conformity with standards:

IEC 60947-5-1, EN 60947-5-1.

⚠ If not expressly indicated in this chapter, for correct installation and utilization of all articles see the instructions given on pages 337 to 350.

### Electrical data

### Utilization category

without connector	Thermal current ( $I_{th}$ ):	10 A	Alternating current: AC15 (50±60 Hz)			
	Rated insulation voltage ( $U_i$ ):	500 Vac 600 Vdc	$U_e$ (V)	250	400	500
	Rated impulse withstand voltage ( $U_{imp}$ ):	400 Vac 500 Vdc (contact blocks 20, 21, 22, 33, 34)	$I_e$ (A)	6	4	1
		6 kV	Direct current: DC13			
Conditional short circuit current: Protection against short circuits: Pollution degree:	4 kV (contact blocks 20, 21, 22, 33, 34)	$U_e$ (V)	24	125	250	
	1000 A acc. to EN 60947-5-1	$I_e$ (A)	3	0.55	0.3	
	type aM fuse 10 A 500 V					
	3					

with M12 connector, 4 and 5-pole	Thermal current ( $I_{th}$ ):	4 A	Alternating current: AC15 (50±60 Hz)			
	Rated insulation voltage ( $U_i$ ):	250 Vac 300 Vdc	$U_e$ (V)	24	120	250
	Protection against short circuits: Pollution degree:	type gG fuse 4 A 500 V	$I_e$ (A)	4	4	4
		3	Direct current: DC13			
		$U_e$ (V)	24	125	250	
		$I_e$ (A)	3	0.55	0.3	

with M12 connector, 8-pole	Thermal current ( $I_{th}$ ):	2 A	Alternating current: AC15 (50±60 Hz)			
	Rated insulation voltage ( $U_i$ ):	30 Vac 36 Vdc	$U_e$ (V)	24		
	Protection against short circuits: Pollution degree:	type gG fuse 2 A 500 V	$I_e$ (A)	2		
		3	Direct current: DC13			
		$U_e$ (V)	24			
		$I_e$ (A)	2			



## Description



These rope-operated safety switches are installed on machines or conveyor belts and facilitate the simple shut-down of the machine from any point and with any pull on the rope.

Provided with self-control function, they allow the constant monitoring of correct functioning, signalling with the opening of the contacts an eventual loosening or breaking of the rope.

## Head with variable orientation

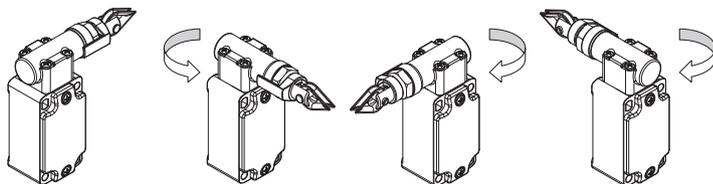

For all switches, the head can be adjusted in 90° steps after removing the four fastening screws.

## Protection degree IP67

# IP67

These devices are designed to be used in the toughest environmental conditions and they pass the IP67 immersion test acc. to EN 60529. They can therefore be used in all environments where maximum protection degree of the housing is required.

## Extended temperature range

# -40°C

These devices are also available in a special version suitable for an ambient operating temperature range from -40°C up to +80°C.

They can therefore be used for applications in cold stores, sterilisers and other equipment with low temperature environments. The special materials used to produce these versions retain their characteristics even under these conditions, thereby expanding the installation possibilities.

## Indicator for rope adjustment

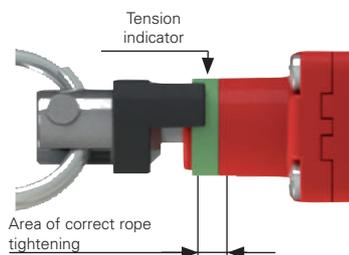

The switches (head 79 and 80) are provided with a green ring that shows the area of the correct tightening of the rope. The installer has only to tighten the rope until the black indicator will be in the middle of the green area. If the tension (or loosening) on the rope is so high that the black indicator exits the green area, the

electrical safety contacts will open.

## Actuating forces

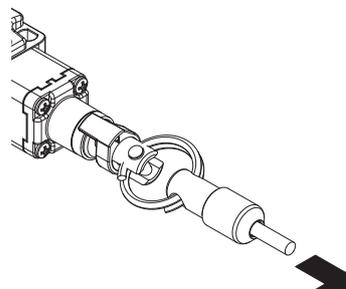

These switches can be supplied with reduced hardness internal springs on request. The force required to actuate the switch can thereby be reduced without changing the actuating path of the electrical contacts. This is particularly advantageous for smaller spans, but must, however, always make use of rope pulleys.

## Features approved by IMQ

Rated insulation voltage (U):	500 Vac 400 Vac (for contact blocks 20, 21, 22, 33, 34)
Conventional free air thermal current (I <sub>th</sub> ):	10 A
Protection against short circuits:	type aM fuse 10 A 500 V
Rated impulse withstand voltage (U <sub>imp</sub> ):	6 kV 4 kV (for contact blocks 20, 21, 22, 33, 34)
Protection degree of the housing:	IP67
MV terminals (screw terminals)	
Pollution degree:	3
Utilization category:	AC15
Operating voltage (U <sub>e</sub> ):	400 Vac (50 Hz)
Operating current (I <sub>a</sub> ):	3 A

Forms of the contact element: Zb, Y+Y, Y+Y+X, Y+Y+Y, Y+X+X  
Positive opening contacts on contact blocks 8, 9, 18, 20, 21, 22, 33, 34  
In compliance with standards: EN 60947-1, EN 60947-5-1, fundamental requirements of the Low Voltage Directive 2014/35/EU.

Please contact our technical department for the list of approved products.

## Features approved by UL

Electrical Ratings:	Q300 pilot duty (69 VA, 125-250 V dc) A600 pilot duty (720 VA, 120-600 V ac)
Environmental Ratings:	Types 1, 4X, 12, 13
Use 60 or 75°C copper (Cu) conductor and wire size range 12, 14 AWG, stranded or solid.	
The terminal tightening torque of 7.1 lb in (0.8 Nm).	
For FR, FP, FX series: the hub is to be connected to the conduit before the hub is connected to the enclosure.	

Please contact our technical department for the list of approved products.





Contact type: L = slow action	Technopolymer housing	Metal housing	Technopolymer housing	Metal housing
Contact blocks				
8 L	FR 874-M2 (+) 1NC	FM 874-M2 (+) 1NC	FX 874-M2 (+) 1NC	FZ 874-M2 (+) 1NC
Actuating force	Initial 63 N...final 83 N (90 N →)	Initial 63 N...final 83 N (90 N →)	Initial 63 N...final 83 N (90 N →)	Initial 63 N...final 83 N (90 N →)
Travel diagrams	Page 204 - group 3	Page 204 - group 3	Page 204 - group 3	Page 204 - group 3

### How to read travel diagrams

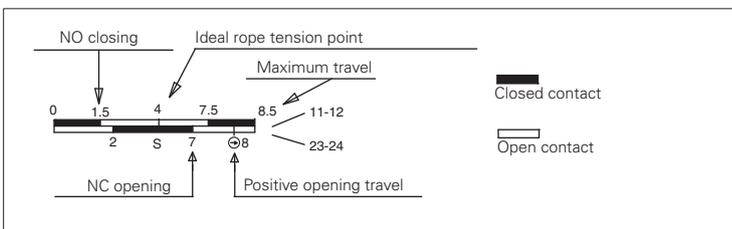

#### IMPORTANT:

In **safety applications**, actuate the switch **at least up to the positive opening travel** shown in the travel diagrams with symbol ⊕. Actuate the switch **at least with the positive opening force**, reported in brackets below each article, next to the actuating force value.

### Travel diagrams table

Contact blocks	Group 1	Group 2	Group 3
8 1NC			
9 2NC			
18 1NO+1NC			
20 1NO+2NC			
21 3NC			
22 2NO+1NC			
33 1NC+1NO			
34 2NC			

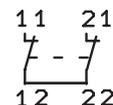

In the rest position (with rope correctly tightened) the two contacts of **contact block 8** are both closed and are activated respectively by tightening or loosening the rope. In order to use this contact block for safety applications it is necessary to connect the two contacts in series. For this reason, in the wiring diagrams the **contact block 8** is indicated as 1NC, whereas in travel diagrams both contacts are indicated.

## Application examples and max. rope length for switches with longitudinal head

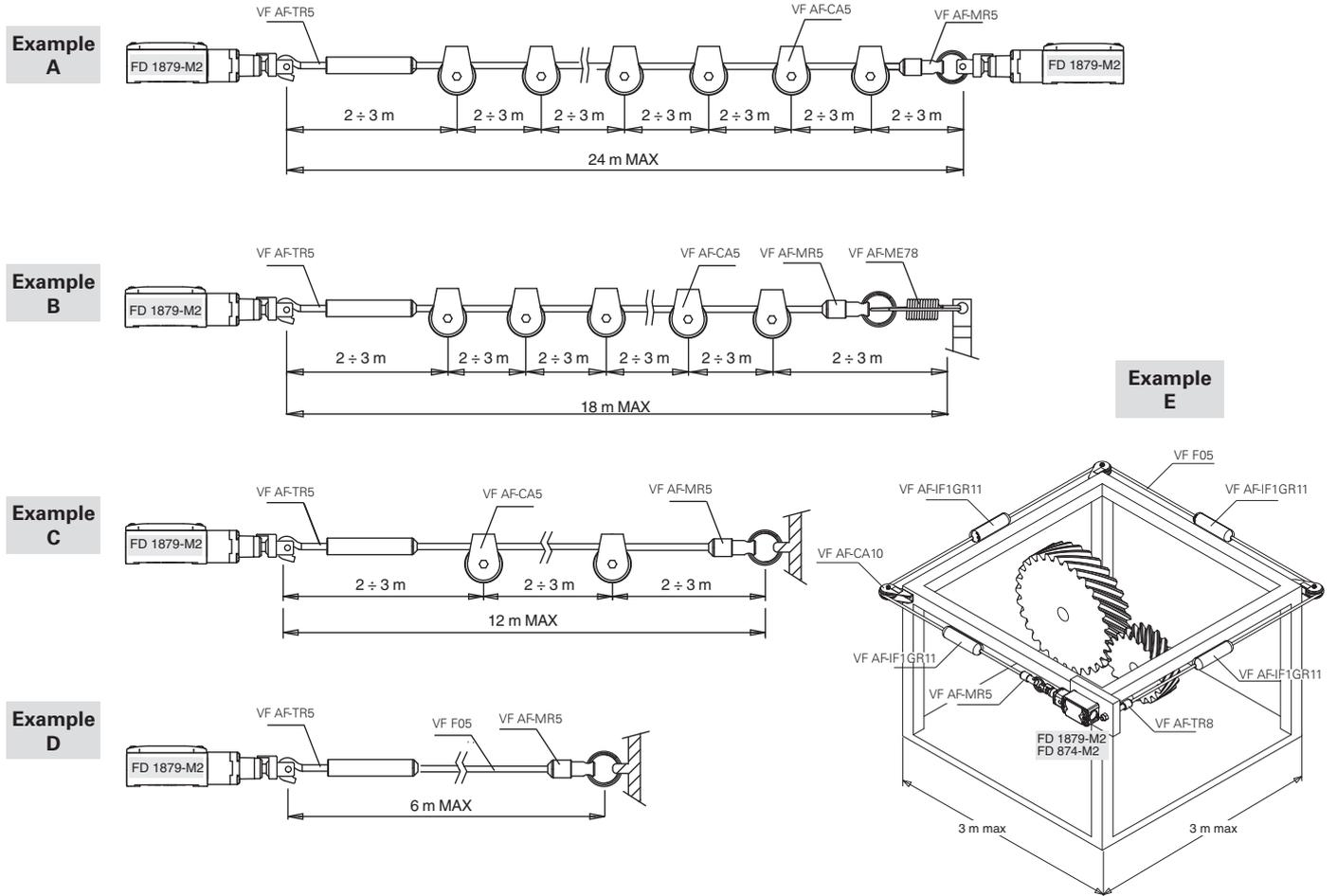

## Application examples and max. rope length for switches with transversal head

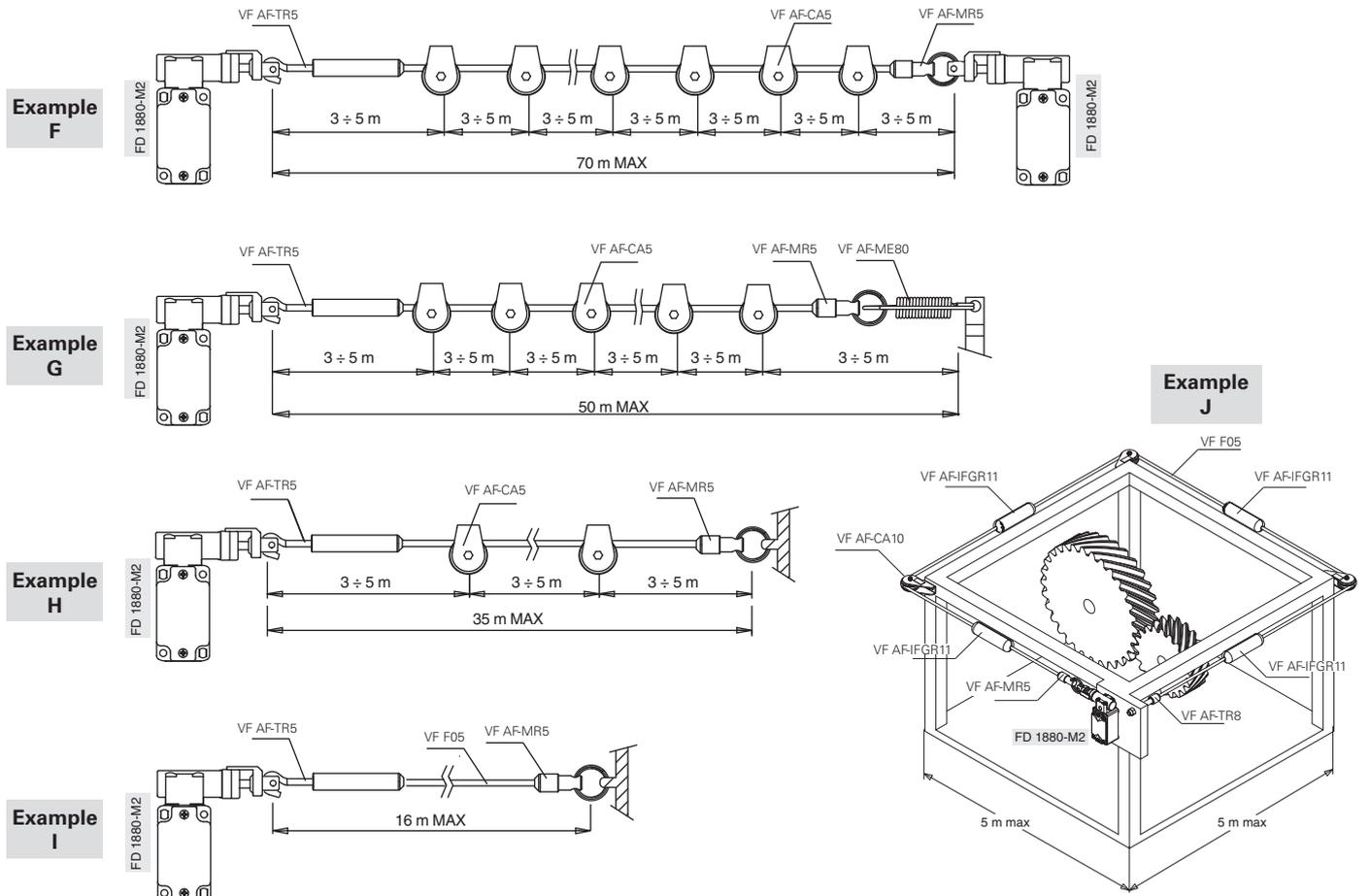

## Maximum spans

Maximum spans for switches with longitudinal head

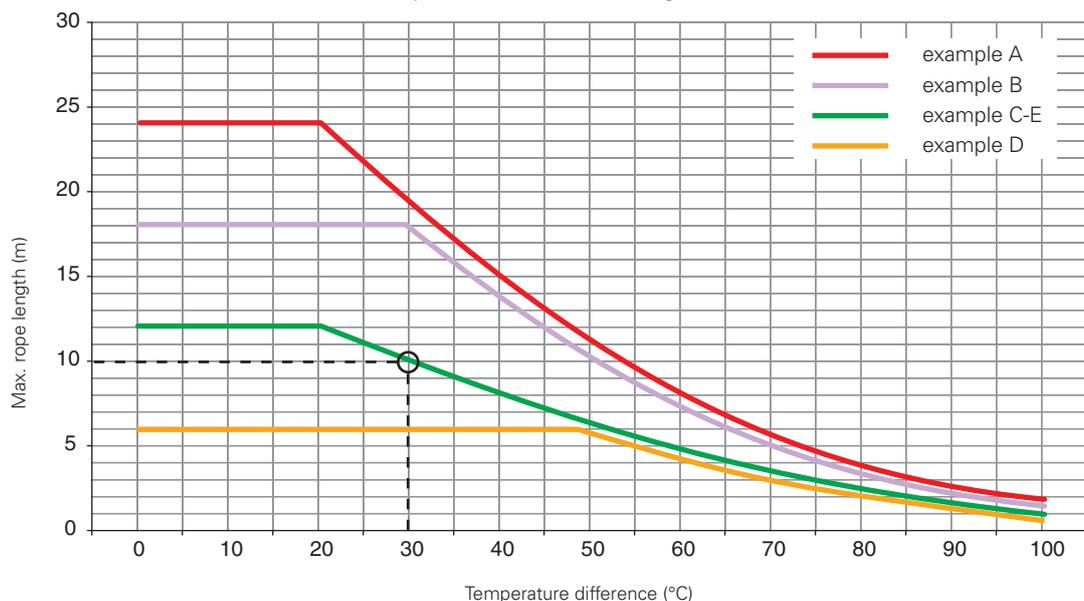

The max. recommended spans are indicated in the diagram as a function of the temperature fluctuations (temperature differences) to which the switch may be exposed at the point of use. For instance, with installation of type C and a temperature difference of 30°C, the max. recommended rope length is 10 metres.

Maximum spans for switches with transversal head

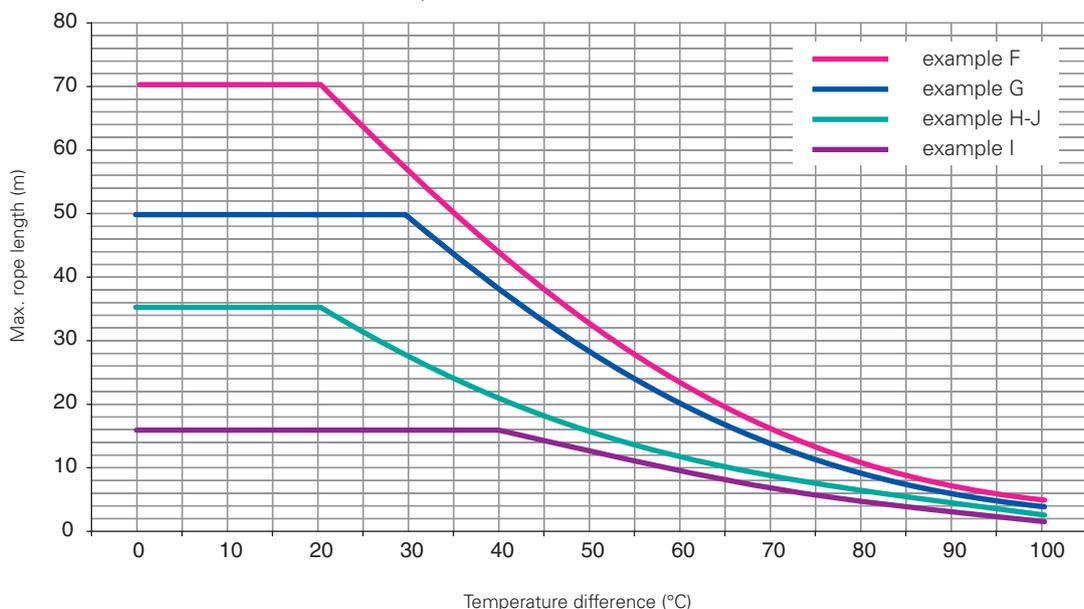

Important: The above data are guaranteed only using original rope and accessories. See page 207.

## Adjustment of the switching point

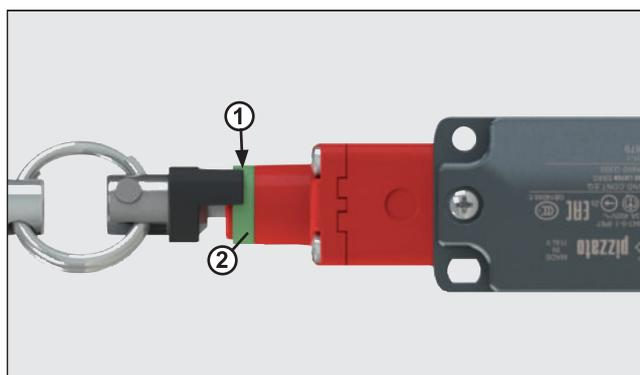

**For switches with head 79 and 80:** Tighten the rope connected to the switch, until the end of the indicator (1) reaches about the middle of the green ring (2).

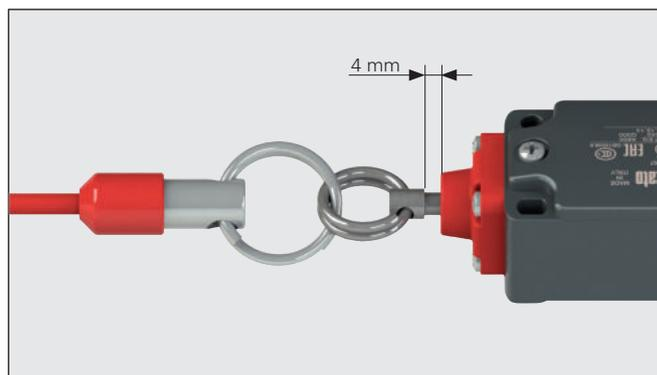

**For switches with head 74:** Tighten the rope connected to the switch until the thimble will be at about 4 mm from the head.

## Accessories for rope installation - FAST line

Article	Description	Article	Description	Article	Description
VF AF-TR5	Adjustable stay bolt	VF AF-MR5	End clamp	VF AF-TR8	Stay bolt

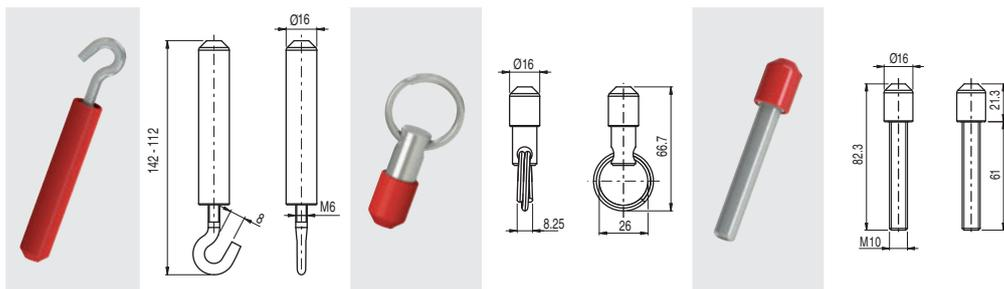

## Accessories for rope installation

Article	Description	Article	Description	Article	Description	Article	Description
VF AF-TR2X	Adjustable stay bolt in stainless steel	VF T870	Stay bolt	VF M870	Terminal	VF C870	Jumper

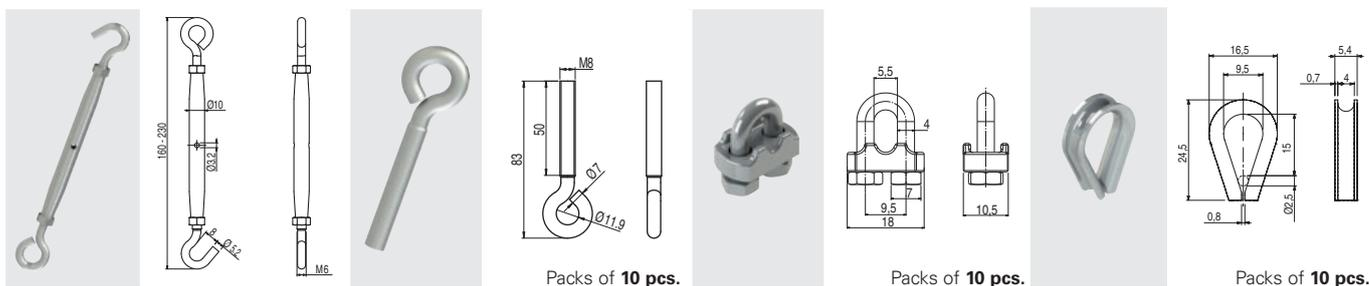

## Pulleys

Article	Description	Article	Description
VF AF-CA5	Stainless steel pulley	VF AF-CA10	Angular pulley, stainless steel

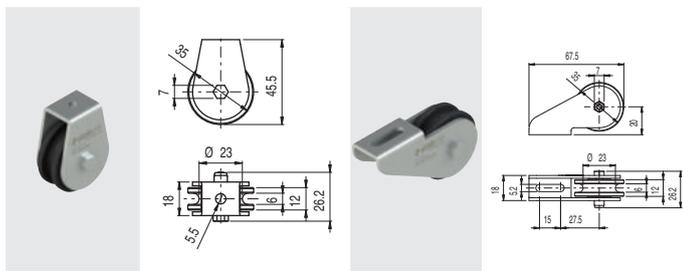

## Safety springs

Article	Description	Article	Description
VF AF-ME78	Safety spring in stainless steel	VF AF-ME80	Safety spring in stainless steel

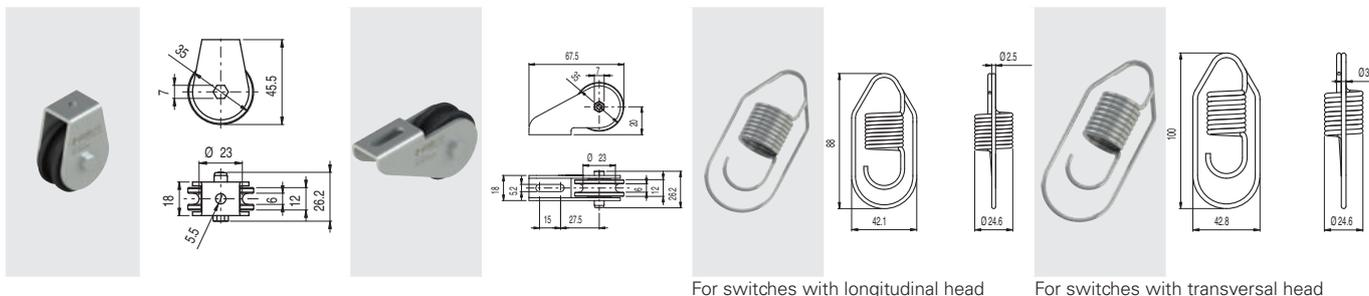

## LED signalling lights

Article	Description
VF SL1A2PA1	White, 24 Vac/dc
VF SL1A3PA1	Red, 24 Vac/dc
VF SL1A4PA1	Green, 24 Vac/dc
VF SL1A5PA1	Yellow, 24 Vac/dc

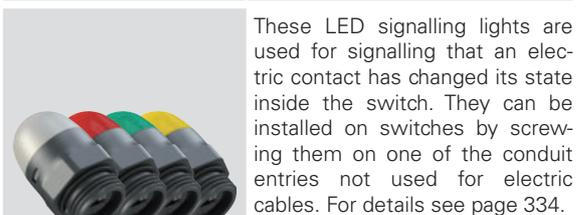

## Function indicators

Article	Engraving	Language	Notes
VF AF-IF1GR00			
VF AF-IF1GR01	STOP EMERGENZA	ita	
VF AF-IF1GR02	EMERGENCY STOP	eng	
VF AF-IF1GR03	STOP	eng	
VF AF-IF1GR04	NOT - AUS	deu	
VF AF-IF1GR05	ARRET D'URGENCE	fra	
VF AF-IF1GR06	PARADA DE EMERGENCIA	esp	
VF AF-IF1GR07	NODSTOP	dan	
VF AF-IF1GR08	⊕ STOP ⊕	eng	
VF AF-IF1GR11	⊕ ⊕		In compliance with EN ISO 13850



Rope function indicators in conformity with standard EN ISO 13850.





## Ropes and further accessories

Article	Description	Weight (Kg)
VF F05-100	100 m of rope on spool	5.1
VF F05-035	35 m of rope on spool	1.8
VF F05-020	20 m of rope, loose	1.0
VF F05-010	10 m of rope, loose	0.5



Zinc-plated steel rope coated with red plastic covering, 5 mm diameter.

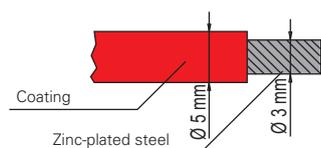

The rope is robust and has long-lasting protection against mechanical damage and corrosion.

Article	Description
VF F05-400	Rope



400 m spool of zinc-plated steel rope coated with red plastic covering, 5 mm diameter.

Weight 20.5 Kg.

Article	Description
VF F05-500B	Rope

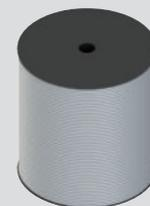

500 m spool of zinc-plated steel rope coated with white plastic covering, 5 mm diameter.

Weight 25.6 Kg.

Article	Description
VF SB400	Rope dispenser



Rope dispenser for 400 m and 500 m spools. This rope dispenser makes it easy to unroll the rope without tangles.

Article	Description
VF SFP2	Ceiling fixing plate



Metal fixing plate, for fixing rope switches on the ceiling.

The plate is provided with bore holes for fastening switches of the series. It is supplied without screws.

## Accessory sets for rope installation - FAST line

Practical installation set containing stay bolts and rope in the same package.



Article	Set content
VF AF-KT10M0	1x VF AF-TR5 1x VF AF-MR5 1x VF F05-010
VF AF-KT20M0	1x VF AF-TR5 1x VF AF-MR5 1x VF F05-020
VF AF-KT35M0	1x VF AF-TR5 1x VF AF-MR5 1x VF F05-035

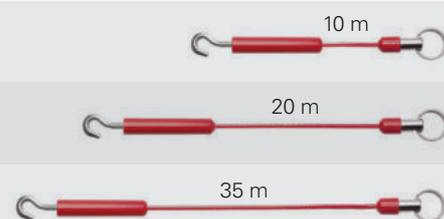

Article	Set content
VF AF-KM10R0	1x VF AF-MR5 1x VF AF-TR8 1x VF F05-010
VF AF-KM20R0	1x VF AF-MR5 1x VF AF-TR8 1x VF F05-020
VF AF-KM35R0	1x VF AF-MR5 1x VF AF-TR8 1x VF F05-035

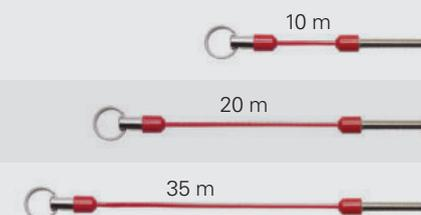

Article	Set content
VF AF-KT10M7	1x VF AF-TR5 1x VF AF-MR5 1x VF F05-010 1x VF AF-ME78
VF AF-KT20M8	1x VF AF-TR5 1x VF AF-MR5 1x VF F05-020 1x VF AF-ME80
VF AF-KT35M8	1x VF AF-TR5 1x VF AF-MR5 1x VF F05-035 1x VF AF-ME80

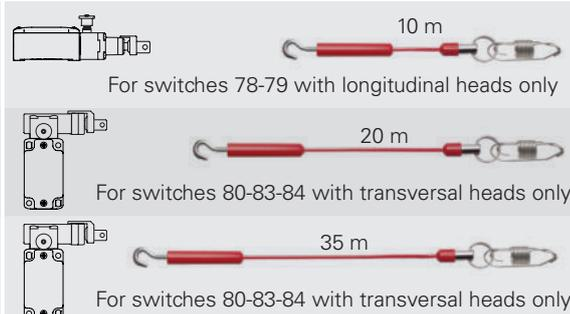

## Combination examples

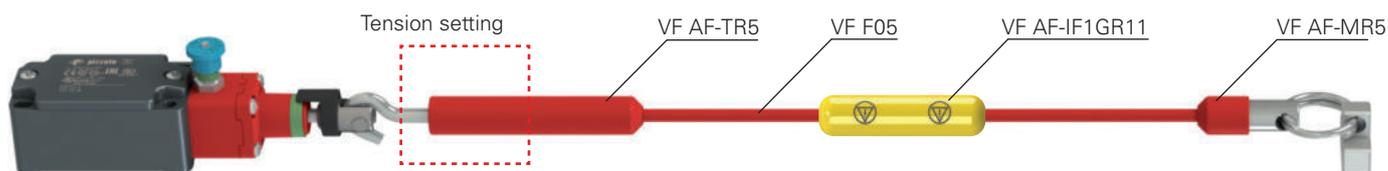

This combination of accessories is suitable for medium rope lengths, where the two rope ends are far away from each other.

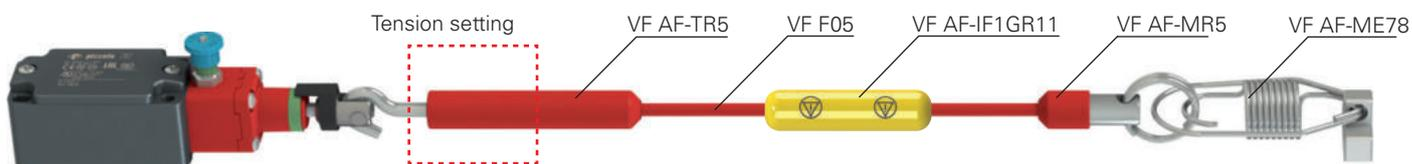

This combination of accessories is suitable for medium-high rope lengths (thanks to VF AF-ME78 safety spring) and where the two rope ends are far away from each other.

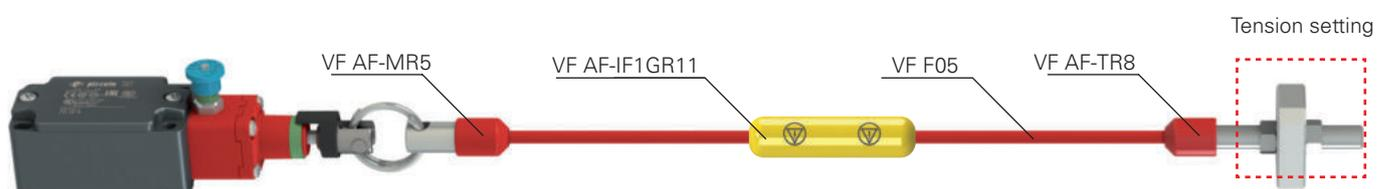

This combination of accessories is suitable for medium rope lengths or where the two rope ends are close to each other.

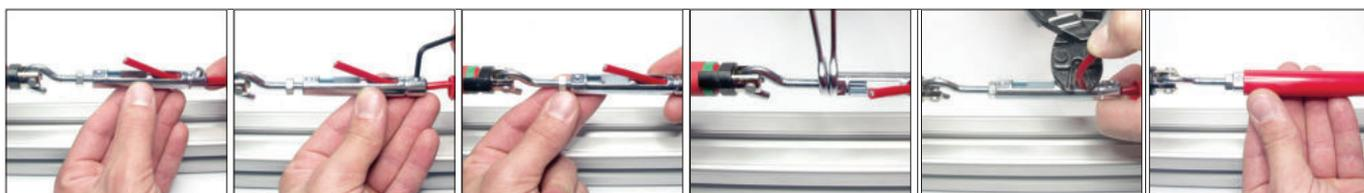
**A Installation of adjustable stay bolt VF AF-TR5**

Rope insertion

Rope fixing

Rope tightening

Stay bolt blocking

Cutting of the rope in excess

Stay bolt covering

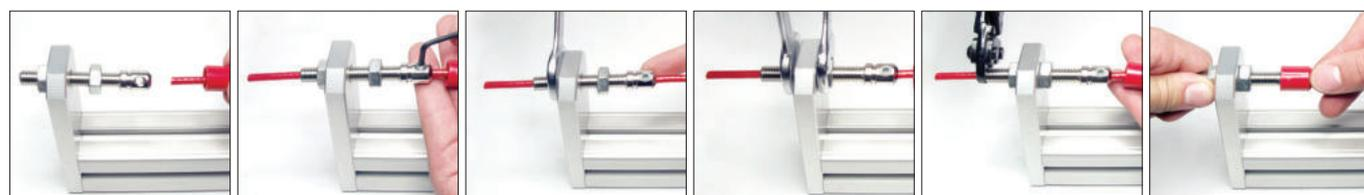
**B Installation of adjustable stay bolt VF AF-TR8**

Rope insertion

Rope fixing

Rope tightening

Stay bolt blocking

Cutting of the rope in excess

Stay bolt covering

**C Installation of end clamp VF AF-MR5**

Rope insertion

Rope fixing

Clamp covering

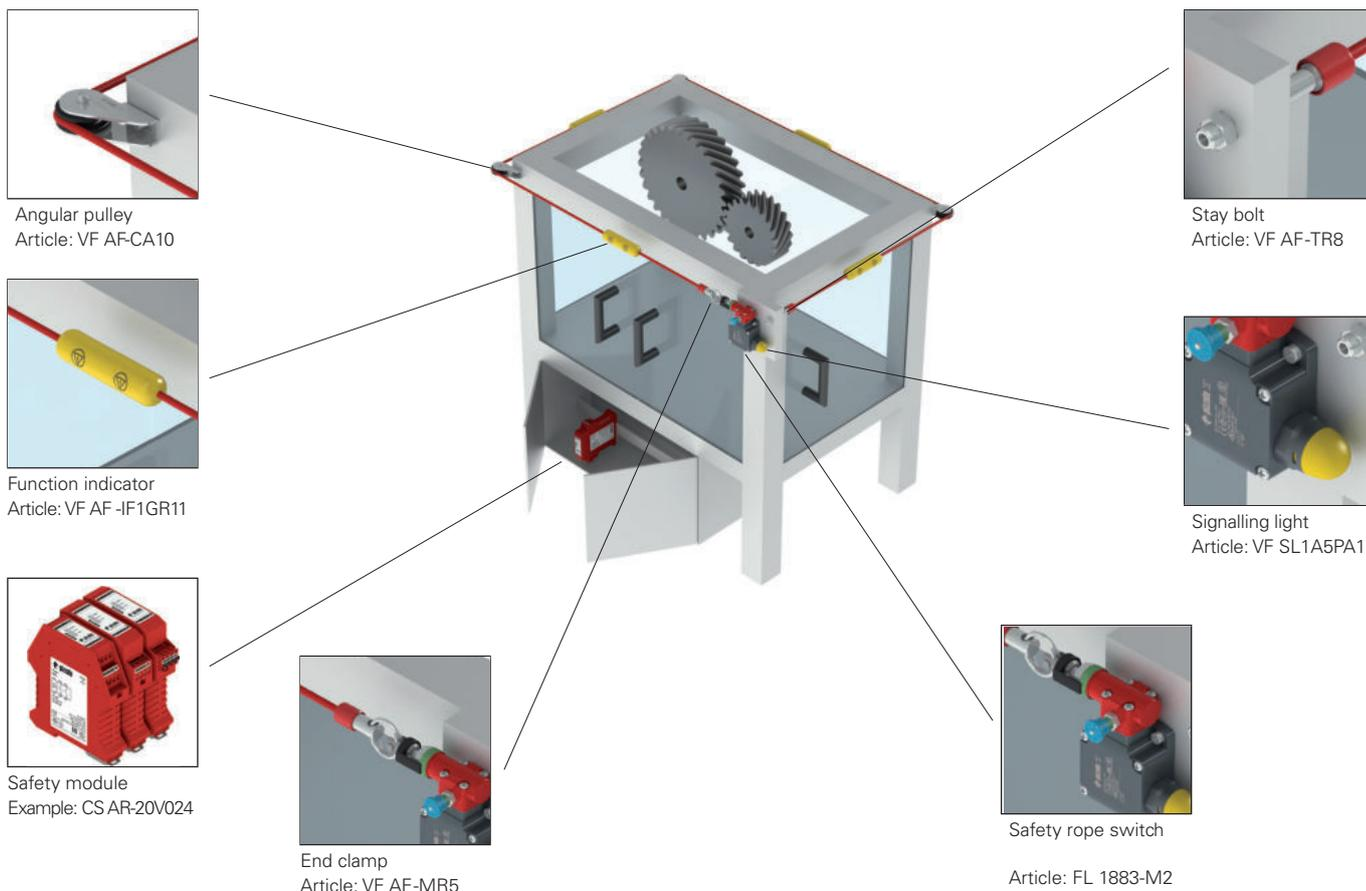
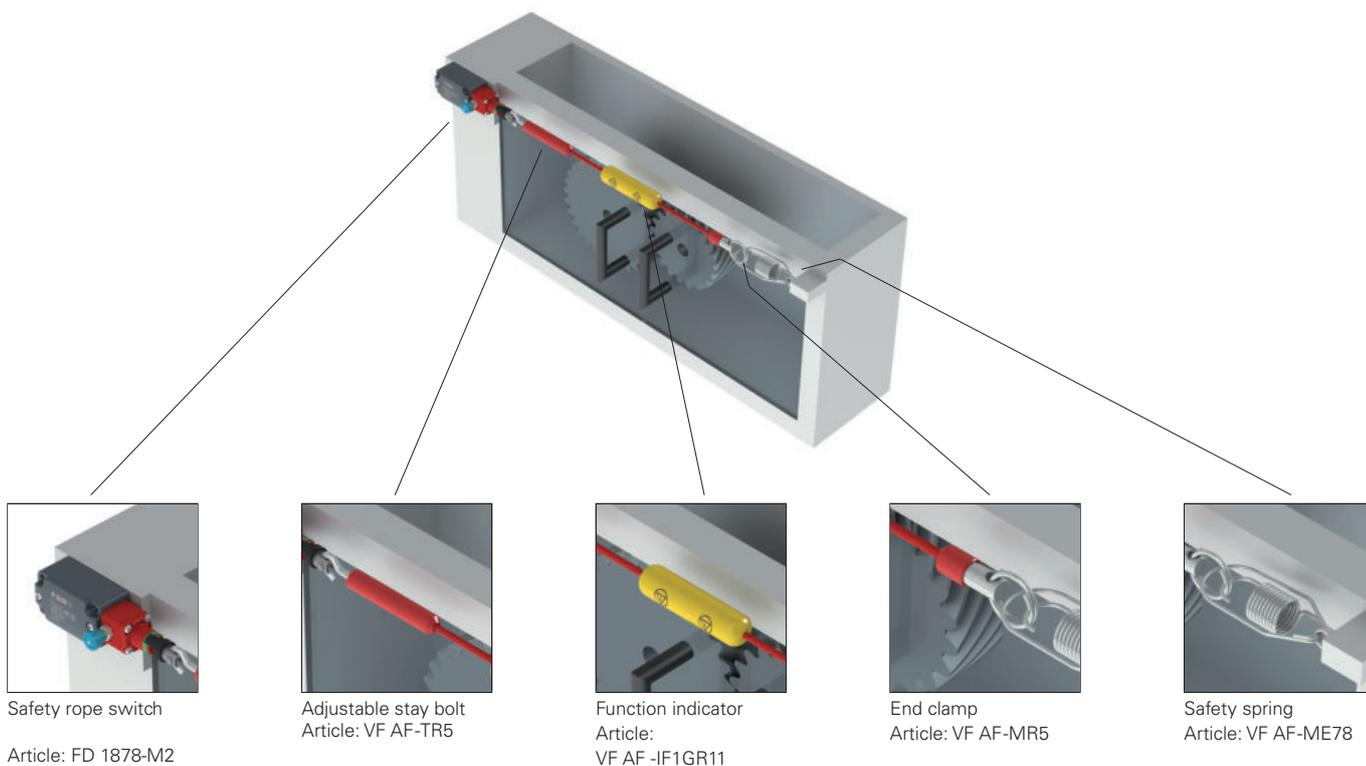
**Application example: possibility of emergency stop along the whole perimeter of the machine with rope supported by angular pulleys**

**Application example: availability of emergency stop along the frontal section of the machine**

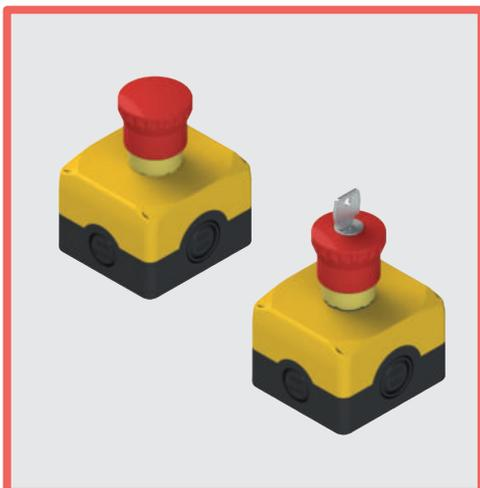
Any information or application example, connection diagrams included, described in this document are to be intended as purely descriptive.  
The choice and application of the products in conformity with the standards, in order to avoid damage to persons or goods, is the user's responsibility.



### Main features

- Protection degrees IP67 and IP69K
- Stainless steel captive screws
- 4 side cable entries
- Screw caps included in the scope of supply

### Quality marks:



EAC approval: RU C-IT.YT03.B.00035/19

### Technical data

#### Housing

Material:

Self-extinguishing shock-proof polycarbonate with double insulation, UV-resistant and glass fibre reinforced, high shock resistance.

Material of the screws:

Stainless steel

Conduit entries:

4x knock-out side entries:  
N°2 M20 - 1/2 NPT, N°2 M20 - 1/2NPT - M25  
2x M16 knock-out base entries

Emergency stop button

Mechanical endurance:

300,000 operating cycles

Max. actuation frequency:

3600 operating cycles/hour

Actuation travel:

4 mm (NO contact),  
4 mm (NC contact)

Actuating force:

25 N

Actuating force at limit of travel:

Push-pull 18.5 N (without contacts)  
Rotary release, 35 N (without contacts)

Maximum travel:

9 mm

Tightening torque of the fixing ring:

2 ... 2.5 Nm

### General data

Protection degree:

IP67 acc. to EN 60529, (with cable gland of equal or higher protection degree)

IP69K acc. to ISO 20653

(only for versions without luminous disc)

Ambient temperature:

-25°C ... +80°C

Tightening torque of the cover screws:

1 ... 1.4 Nm

Utilization requirements:

see page 149 of the General Catalogue HMI

### In compliance with standards:

IEC 60947-1, IEC 60947-5-1, IEC 60204-1, EN 60947-1, EN 60947-5-1, EN 60204-1, EN 50581, EN ISO 13850, UL 508, CSA 22-2 N°14.

### Compliance with the requirements of:

Machinery Directive 2006/42/EC, EMC Directive 2014/30/EU, RoHS Directive 2011/65/EU.

### General data

#### Protection degrees IP67 and IP69K

**IP69K**  
**IP67**

These devices are designed to be used in the toughest environmental conditions and they pass the IP67 immersion test acc. to EN 60529. They can therefore be used in all environments where maximum protection degree of the housing is required. Due to their special design,

these devices are suitable for use in equipment subjected to cleaning with high pressure hot water jets. These devices meet the IP69K test requirements according to ISO 20653 (water jets with 100 bar and 80°C).

#### Fixing of EROUND housings

The housings of the EROUND line by Pizzato Elettrica have 4 additional holes on the cover. The holes enable wall fixing from the outside by means of insertion of the screws, without the need to open the cover to access the holes.

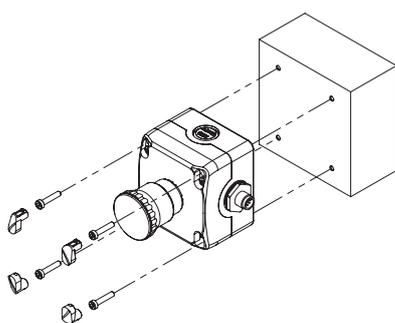

The wall fixing screws and the ones for closing the housing cover can be sealed with 4 caps (supplied with the housing). The caps not only give the housing a more pleasant look, but they also prevent the accumulation of dirt inside the recesses of the screws besides making tampering more difficult.

The external fixing of the housings is particularly valuable for already wired housings, since this simplifies the whole installation: you can simply fix the housing and connect the connector that, thanks to the presence of cable entries on the four sides of the housing, can be oriented in the preferred direction.

#### One housing, two solutions

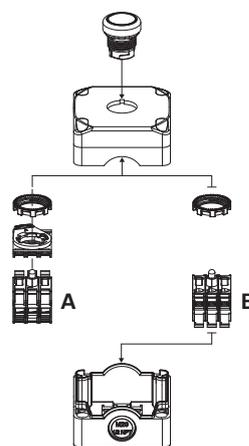

The housing can fit up to 3 contact blocks/LED units (E2 CP, E2 LP) for panel mounting by means of a mounting adapter (A) or up to 3 contact blocks/LED units (E2 CF, E2 LF) for base mounting directly on the bottom of the housing (B).

#### Wiring through the lower surface

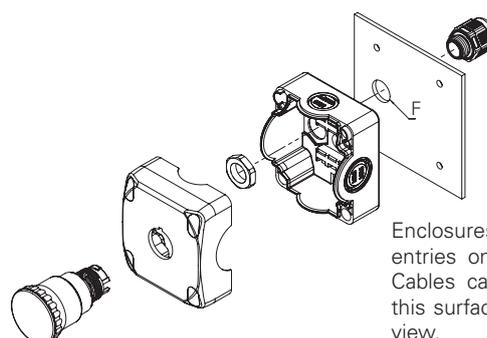

cable gland	F
M16	Ø 25
M20	Ø 28

Enclosures have 2 conduit entries on the lower surface. Cables can be connected via this surface, hiding them from view.



## Complete housing units with emergency stop buttons



Housing cover colour	Actuator design and colour	Contacts			Emergency stop button Push-Pull	Emergency stop button rotary release	Emergency stop button, key release
		pos. 2	pos. 3	pos. 1			
yellow RAL 1003	red	-	1NC ⊕	-	<b>ES AC31004</b> ES 31001 + E2 1PEPZ4531 + E2 CF01G2V1	<b>ES AC31003</b> ES 31001 + E2 1PERZ4531 + E2 CF01G2V1	<b>ES AC31022</b> ES 31001 + E2 1PEBZ4531 + E2 CF01G2V1
yellow RAL 1003	red	-	1NC ⊕ SELF-MONITORED	-	<b>ES AC31081</b> ES 31001 + E2 1PEPZ4531 + E2 CF01S2V1	<b>ES AC31082</b> ES 31001 + E2 1PERZ4531 + E2 CF01S2V1	<b>ES AC31083</b> ES 31001 + E2 1PEBZ4531 + E2 CF01S2V1
yellow RAL 1003	red	1NC ⊕	-	1NC ⊕	<b>ES AC31009</b> ES 31001 + E2 1PEPZ4531 + E2 CF01G2V1 + E2 CF01G2V1	<b>ES AC31005</b> ES 31001 + E2 1PERZ4531 + E2 CF01G2V1 + E2 CF01G2V1	<b>ES AC31023</b> ES 31001 + E2 1PEBZ4531 + E2 CF01G2V1 + E2 CF01G2V1
yellow RAL 1003	red	1NC ⊕	-	1NO	<b>ES AC31010</b> ES 31001 + E2 1PEPZ4531 + E2 CF01G2V1 + E2 CF10G2V1	<b>ES AC31006</b> ES 31001 + E2 1PERZ4531 + E2 CF01G2V1 + E2 CF10G2V1	<b>ES AC31011</b> ES 31001 + E2 1PEBZ4531 + E2 CF01G2V1 + E2 CF10G2V1
yellow RAL 1003	red	1NC ⊕	1NC ⊕	1NO	<b>ES AC31146</b> ES 31001 + E2 1PEPZ4531 + E2 CF01G2V1 + E2 CF01G2V1 + E2 CF10G2V1	<b>ES AC31021</b> ES 31001 + E2 1PERZ4531 + E2 CF01G2V1 + E2 CF01G2V1 + E2 CF10G2V1	<b>ES AC31024</b> ES 31001 + E2 1PEBZ4531 + E2 CF01G2V1 + E2 CF01G2V1 + E2 CF10G2V1

Other combinations on request.  
The standard colour of the base for the codes mentioned above is RAL 9005.  
→ For properties of contact blocks, see the General Catalogue HMI.



Housing cover colour	Actuator design and colour	Contacts			Emergency stop button Push-Pull Yellow luminous disc, flashing Ø 60 mm, 24 Vac/dc	Emergency stop button rotary release Yellow luminous disc, flashing Ø 60 mm, 24 Vac/dc	Emergency stop button, key release Yellow luminous disc, flashing Ø 60 mm, 24 Vac/dc
		pos. 2	pos. 3	pos. 1			
grey RAL 7035	red	1NO	1NC ⊕ CONNECTION BLOCK		<b>ES AC31430</b> ES 31000 + E2 1PEPZ4531 + VE DL1A5L13 + E2 CP10G2V1 + E2 CP01G2V1 + VE BC2PV1	<b>ES AC31433</b> ES 31000 + E2 1PERZ4531 + VE DL1A5L13 + E2 CP10G2V1 + E2 CP01G2V1 + VE BC2PV1	<b>ES AC31436</b> ES 31000 + E2 1PEBZ4531 + VE DL1A5L13 + E2 CP10G2V1 + E2 CP01G2V1 + VE BC2PV1
grey RAL 7035	red	1NO	1NC ⊕ SELF-MONITORED		<b>ES AC31431</b> ES 31000 + E2 1PEPZ4531 + VE DL1A5L13 + E2 CP10G2V1 + E2 CP01S2V1 + VE BC2PV1	<b>ES AC31434</b> ES 31000 + E2 1PERZ4531 + VE DL1A5L13 + E2 CP10G2V1 + E2 CP01S2V1 + VE BC2PV1	<b>ES AC31437</b> ES 31000 + E2 1PEBZ4531 + VE DL1A5L13 + E2 CP10G2V1 + E2 CP01S2V1 + VE BC2PV1
grey RAL 7035	red	1NO	2NC ⊕ CONNECTION BLOCK		<b>ES AC31432</b> ES 31000 + E2 1PEPZ4531 + VE DL1A5L13 + E2 CP10G2V1 + E2 CP02G2V1 + VE BC2PV1	<b>ES AC31435</b> ES 31000 + E2 1PERZ4531 + VE DL1A5L13 + E2 CP10G2V1 + E2 CP02G2V1 + VE BC2PV1	<b>ES AC31438</b> ES 31000 + E2 1PEBZ4531 + VE DL1A5L13 + E2 CP10G2V1 + E2 CP02G2V1 + VE BC2PV1

Other combinations on request.  
The standard colour of the base for the codes mentioned above is RAL 9005.  
→ For the properties of contact blocks and luminous discs, please see the General Catalogue HMI.

Spare caps	
Article	Description
 <b>VETS35RA1</b>	4 spare caps for ES series housing cover. Colour: yellow
 <b>VETS39RA1</b>	4 spare caps for ES series housing cover. Colour: grey

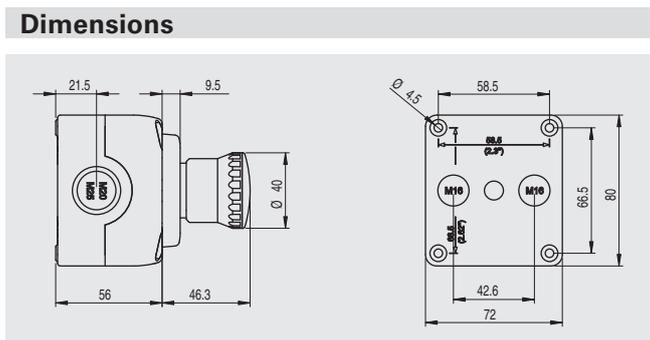

All values in the drawings are in mm

Accessories See page 319

→ The 2D and 3D files are available at [www.pizzato.com](http://www.pizzato.com)

Product code	Supply voltage	For applications up to			Output contacts			Housing dimensions
		PL	SIL	Safety category	instantaneous	delayed	feedback	

### Safety modules for emergency stops and end position monitoring for movable guards

CS AR-01	24 Vac/dc; 120 Vac; 230 Vac: 10...30 Vdc	e	3	4	2 NO + 1 NC	-	-	22,5 x 114 mm
CS AR-02	24 Vac/dc; 120 Vac; 230 Vac: 10...30 Vdc	e	3	4	3 NO	-	-	22,5 x 114 mm
CS AR-04	24 Vac/dc; 120 Vac; 230 Vac	e	3	4	3 NO + 1 NC	-	-	22,5 x 114 mm
CS AR-05	24 Vac/dc; 120 Vac; 230 Vac	e	3	4	3 NO + 1 NC	-	-	22,5 x 114 mm
CS AR-06	24 Vac/dc; 120 Vac; 230 Vac	e	3	4	3 NO + 1 NC	-	-	22,5 x 114 mm
CS AR-07	24 Vac/dc	e	3	4	4 NO + 1 NC	-	-	22,5 x 129 mm
CS AR-08	12 Vdc, 24 Vac/dc; 120 Vac; 230 Vac	e	3	4	2 NO	-	-	22,5 x 114 mm
CS AR-20	24 Vac/dc; 120 Vac; 230 Vac	e	3	3	2 NO	-	-	22,5 x 114 mm
CS AR-21	24 Vac/dc; 120 Vac; 230 Vac	e	3	3	2 NO	-	-	22,5 x 114 mm
CS AR-22	24 Vac/dc; 120 Vac; 230 Vac	e	3	3	3 NO + 1 NC	-	-	22,5 x 114 mm
CS AR-23	24 Vac/dc; 120 Vac; 230 Vac	e	3	3	3 NO + 1 NC	-	-	22,5 x 114 mm
CS AR-24	24 Vac/dc	e	3	3	4 NO + 1 NC	-	-	22,5 x 114 mm
CS AR-25	24 Vac/dc	e	3	3	4 NO + 1 NC	-	-	22,5 x 114 mm
CS AR-40	24 Vac/dc	d	2	2	2 NO	-	-	22,5 x 91 mm
CS AR-41	24 Vac/dc	d	2	2	2 NO	-	-	22,5 x 91 mm
CS AR-46	24 Vac/dc	c	1	1	1 NO	-	-	22,5 x 91 mm
CS AR-91	24 Vac/dc	e	3	4	2 NO + 1 OPT	-	-	22,5 x 114 mm

### Module for emergency stops, end position monitoring for movable guards, safety mats and safety bumpers with 4-wire technology

CS AR-51	24 Vac/dc	e	3	4	2 NO	-	-	22,5 x 114 mm
----------	-----------	---	---	---	------	---	---	---------------

### Safety modules for emergency stop and end position monitoring for movable guards with delayed contacts upon opening of the inputs

CS AT-0③	24 Vac/dc; 120 Vac; 230 Vac	e	3	4 (②)	2 NO + 1 NC	2 NO	-	45 x 114 mm
CS AT-1③	24 Vac/dc; 120 Vac; 230 Vac	e	3	4 (②)	3 NO	2 NO	-	45 x 114 mm
CS AT-3③	24 Vac/dc	e	3	4 (②)	2 NO	1 NO	-	45 x 114 mm

### Safety timer modules

CS FS-1③	24 Vac/dc; 120 Vac; 230 Vac	①	①	①	-	1 NO + 2 NC	-	45 x 114 mm
CS FS-2③	24 Vdc; 120 Vac	d	2	3	-	1 NO + 1 NC + 1 CO	-	45 x 114 mm
CS FS-3③	24 Vdc; 120 Vac	d	2	3	-	1 NO + 1 NC + 1 CO	-	45 x 114 mm
CS FS-5③	24 Vdc; 120 Vac	d	2	3	-	1 NO + 1 NC + 1 CO	-	45 x 114 mm

### Safety modules for two-hand controls or synchronism monitoring

CS DM-01	24 Vac/dc; 120 Vac; 230 Vac	III C acc. to EN 574			3 NO + 1 NC	-	-	22,5 x 114 mm
CS DM-02	24 Vac/dc; 120 Vac; 230 Vac	III C acc. to EN 574			2 NO	-	-	22,5 x 114 mm
CS DM-20	24 Vac/dc; 120 Vac; 230 Vac	III A acc. to EN 574			2 NO	-	-	22,5 x 114 mm

### Safety modules for motor standstill monitoring

CS AM-01	24 ... 230 Vac/dc	d	2	3	2 NO + 1 NC	-	-	45 x 114 mm
----------	-------------------	---	---	---	-------------	---	---	-------------

### Expansion modules with instantaneous contacts or delayed contacts at de-energizing

CS ME-01	24 Vac/dc	①	①	①	5 NO + 1 NC	-	1 NC	22,5 x 114 mm
CS ME-02	24 Vdc	①	①	①	4 NO + 2 NC	-	1 NC	22,5 x 114 mm
CS ME-03	24 Vdc	①	①	①	3 NO	-	1 NC	22,5 x 91 mm
CS ME-20VU24-⑤	24 Vdc	①	①	①	-	4 NO + 2 NC	1 NC	22,5 x 114 mm
CS ME-30VU24-⑥	24 Vdc	①	①	①	-	4 NO + 2 NC	1 NC	45 x 114 mm
CS ME-31VU24-TS12	24 Vdc	①	①	①	-	4 NO + 2 NC	1 NC	45 x 114 mm

- Available for this article
- Not available for this article
- ① Depending on the base module
- ② Category 4 for instantaneous contacts, category 3 for delayed contacts

- ③ Release times for delayed contacts
  - 0 fixed time
  - 1 adjustable, 0,3 ... 3 s, 0,3 s steps
  - 2 adjustable, 1 ... 10 s, 1 s steps
  - 3 adjustable, 3 ... 30 s, 3 s steps
  - 4 adjustable, 30 ... 300 s, 30 s steps

- ④ Connection type
  - V Screw terminals
  - M Connector with screw terminals
  - X Connector with spring terminals

- ⑤ Release time in absence of power supply
  - TF0.5 0,5 s fixed time
  - TF1 1 s fixed time
  - TF2 2 s fixed time
  - TF3 3 s fixed time



Product code	Autom. & manual start	Monitored start	Inputs of opposite potentials	Equipotential inputs	Parallel start (24 Vdc only)	Input type (7)				Connection type (4)			Page
										V	M	X	
CS AR-01	■	■	■	-	■	■	-	⑧	-	■	■	■	215
CS AR-02	■	■	■	-	■	■	-	⑧	-	■	■	■	217
CS AR-04	■	■	■	-	■	■	-	⑧	-	■	■	■	219
CS AR-05	■	-	■	■	■	■	■	■	-	■	■	■	221
CS AR-06	-	■	■	■	■	■	■	■	-	■	■	■	221
CS AR-07	■	■	■	-	■	■	-	-	-	-	■	■	223
CS AR-08	■	■	■	■	■	■	■	■	-	■	■	■	225
CS AR-20	■	-	-	-	-	■	-	-	-	■	■	■	227
CS AR-21	-	■	-	-	-	■	-	-	-	■	■	■	227
CS AR-22	■	-	-	-	-	■	-	-	-	■	■	■	229
CS AR-23	-	■	-	-	-	■	-	-	-	■	■	■	229
CS AR-24	■	-	-	-	-	■	-	-	-	■	■	■	231
CS AR-25	-	■	-	-	-	■	-	-	-	■	■	■	231
CS AR-40	■	-	-	-	-	■	-	-	-	■	■	■	233
CS AR-41	-	■	-	-	-	■	-	-	-	■	■	■	233
CS AR-46	■	-	■	-	-	■	-	■	-	■	■	■	235
CS AR-91	■	■	■	-	■	■	-	■	-	■	■	■	237
CS AR-51	■	■	■	-	-	■	-	-	■	■	■	■	239
CS AT-0③	■	■	■	■	■	■	■	■	-	■	■	■	241
CS AT-1③	■	■	■	■	■	■	■	■	-	■	■	■	243
CS AT-3③	■	■	■	-	-	■	-	■	-	■	■	■	245
CS FS-1③	-	-	-	-	-	■	-	-	-	■	■	■	247
CS FS-2③	-	-	-	-	-	■	-	-	-	■	■	■	249
CS FS-3③	-	-	-	-	-	■	-	-	-	■	■	■	251
CS FS-5③	■	■	-	■	-	■	-	■	-	■	■	■	253
CS DM-01	-	-	■	-	-	■	-	-	-	■	■	■	255
CS DM-02	-	-	■	-	-	■	-	-	-	■	■	■	257
CS DM-20	-	-	■	-	-	■	-	-	-	■	■	■	259
CS AM-01	-	-	-	-	-	■	-	-	-	■	■	■	261
CS ME-01	-	-	①	①	-	■	-	-	-	■	■	■	263
CS ME-02	-	-	①	①	-	■	-	-	-	■	■	■	265
CS ME-03	-	-	-	■	-	■	■	-	-	■	■	■	267
CS ME-20VU24-⑤	-	-	①	①	-	■	-	-	-	■	■	■	269
CS ME-30VU24-⑥	-	-	①	①	-	■	-	-	-	■	■	■	271
CS ME-31VU24-TS12	-	-	①	①	-	■	-	-	-	■	■	■	271

③ Release time in absence of power supply  
 TF1 1 s fixed time  
 ... ..  
 TF12 12 s fixed time

⑦ Input type  
 electromechanical contacts  
 semiconductor outputs (e.g. light barriers)  
 magnetic safety sensors  
 4-wire safety mats and safety bumpers

⑧ Modules compatible with magnetic sensors from June 2014

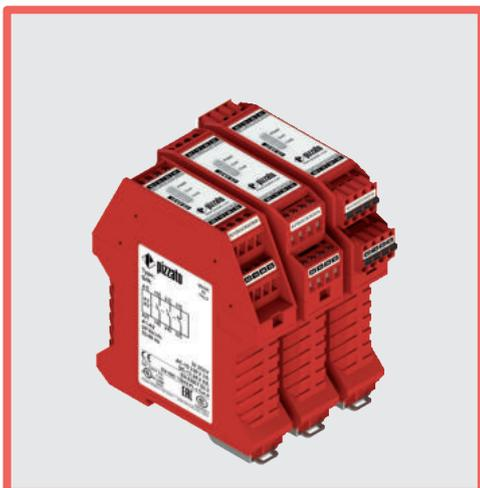

### Module for emergency stops, end position monitoring for movable guards and magnetic safety sensors

#### Main features

- For safety applications up to SIL CL 3/PL e
- Input with 1 or 2 channels
- Choice between automatic start, manual start or monitored start
- Connection of input channels of opposite potentials
- Reduced housing width of 22.5 mm
- Output contacts:
  - 2 NO safety contacts,
  - 1 NC auxiliary contact
- Supply voltage:
  - 10 ... 30 Vdc, 24 Vac/dc, 120 Vac, 230 Vac

#### Utilization categories

Alternating current: AC15 (50...60 Hz)

U<sub>e</sub> (V) 230

I<sub>e</sub> (A) 3

Direct current: DC13 (6 oper. cycles/min.)

U<sub>e</sub> (V) 24

I<sub>e</sub> (A) 4

#### Quality marks:



EC type examination certificate: IMQ CP 432 DM

UL approval: E131787

CCC approval: 2013010305640211

EAC approval: RU C-IT.YT03.B.00035/19

#### Compliance with the requirements of:

Machinery Directive 2006/42/EC,

EMC Directive 2014/30/EC,

RoHS Directive 2011/65/EU.

## Technical data

### Housing

Polyamide housing PA 66, self-extinguishing V0 acc. to UL 94

Protection degree acc. to EN 60529:

IP40 (housing), IP20 (terminal strip)

Dimensions:

see page 317, design A

### General data

SIL level (SIL CL) up to:

SIL CL 3 acc. to EN 62061

Performance Level (PL) up to:

PL e acc. to EN ISO 13849-1

Safety category up to:

cat. 4 acc. to EN ISO 13849-1

Safety parameters:

see page 375

Ambient temperature:

-25°C...+55°C

Mechanical endurance:

>10 million operating cycles

Electrical endurance:

>100,000 operating cycles

Pollution degree:

external 3, internal 2

Rated impulse withstand voltage (U<sub>imp</sub>):

4 kV

Rated insulation voltage (U<sub>i</sub>):

250 V

Overvoltage category:

II

### Supply

Rated supply voltage (U<sub>n</sub>):

10 ... 30 Vdc  
24 Vac/dc; 50...60 Hz  
120 Vac; 50...60 Hz  
230 Vac; 50...60 Hz

Max. DC residual ripple in DC:

10%

Supply voltage tolerance:

±15% of U<sub>n</sub>

Power consumption AC:

< 5 VA

Power consumption DC:

< 2 W

### Control circuit

Protection against short circuits:

PTC resistance, I<sub>h</sub>=0.5 A

PTC times:

Response time > 100 ms, release time > 3 s

Maximum resistance per input:

≤ 50 Ω

Current per input:

30 mA (typical)

Min. duration of start impulse t<sub>MIN</sub>:

> 100 ms, > 50 ms (E02)

Response time t<sub>A</sub>:

< 50 ms, < 150 ms (E02)

Release time t<sub>R1</sub>:

< 20 ms

Release time in absence of power supply t<sub>R2</sub>:

< 70 ms, < 100 ms (E02)

Simultaneity time t<sub>C</sub>:

unlimited

### In compliance with standards:

EN 60204-1, EN ISO 13855, EN 1037, EN ISO 12100, EN ISO 13850, EN 60529, EN 61000-6-2, EN 61000-6-3, EN 61326-1, EN 60664-1, EN 60947-1, EN 50581, EN ISO 13849-1, EN ISO 13849-2, EN 62061, UL 508, CSA C22.2 n° 14-95, GB/T14048.5-2017

### Output circuit

Output contacts:

2 NO safety contacts,  
1 NC auxiliary contact

Contact type:

forcibly guided

Material of the contacts:

gold-plated silver alloy

Maximum switching voltage:

230/240 Vac; 300 Vdc

Max. current per contact:

6 A

Conventional free air thermal current I<sub>th</sub>:

6 A

Max. total current Σ I<sub>th</sub><sup>2</sup>:

72 A<sup>2</sup>

Minimum current:

10 mA

Contact resistance:

≤ 100 mΩ

External protection fuse:

4 A

The number and the load capacity of output contacts can be increased by using expansion modules or contactors. See pages 263-272.

## Code structure

# CS AR-01V024

Connection type	
<b>V</b>	Screw terminals
<b>M</b>	Connector with screw terminals
<b>X</b>	Connector with spring terminals

Supply voltage	
<b>024</b>	24 Vac/dc
<b>120</b>	120 Vac
<b>230</b>	230 Vac
<b>E02</b>	10 ... 30 Vdc

## Features approved by UL

Rated supply voltage (U <sub>n</sub> ):	24 Vac/dc; 50...60 Hz 120 Vac; 50...60 Hz 230 Vac; 50...60 Hz
Power consumption AC:	< 5 VA
Power consumption DC:	< 4 W
Electrical ratings:	230/240 Vac 6 A general use C300 pilot duty

#### Notes:

- Use 60 or 75°C copper (Cu) conductor and wire size No. 30-12 AWG, stranded or solid.
- The terminal tightening torque of 5-7 lb in.
- Only for 24 Vac/dc versions: supply from remote Class 2 source or limited voltage limited energy.





### Safety module CS AR-01

#### Pin assignment

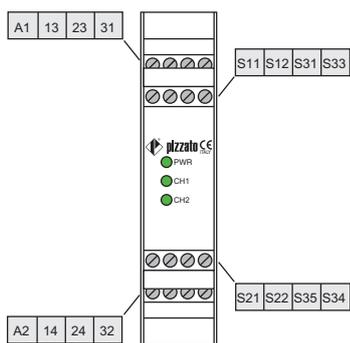

#### Internal block diagram

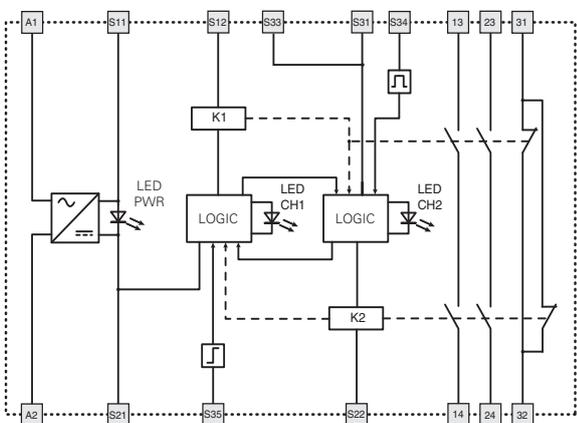

#### Input configuration

Emergency stop circuits	
Input configuration with manual start	
1 channel	2 channels

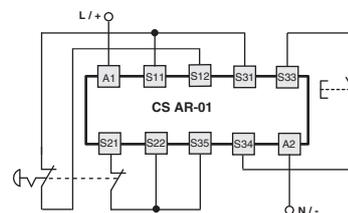
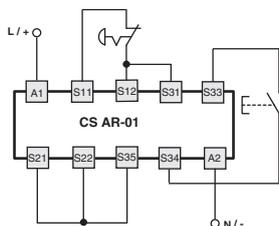

The diagram does not show the exact position of the terminals in the product

#### Automatic start

With regard to the indicated diagrams, bridge the start button between S33 and S34 in order to activate the automatic start module.

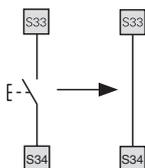

#### Monitored start

With regard to the indicated diagrams, remove the connection between S22 and S35 in order to activate the monitored start module.

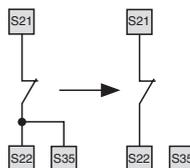

#### Monitoring of movable guards and magnetic safety sensors

The safety module can monitor emergency stop circuits, control circuits for movable guards as well as magnetic safety sensors. Replace the emergency stop contacts with switch contacts or sensor contacts. The sensors can only be used in 2-channel configuration.

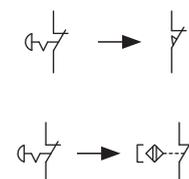

#### Function diagrams

Configuration with automatic start

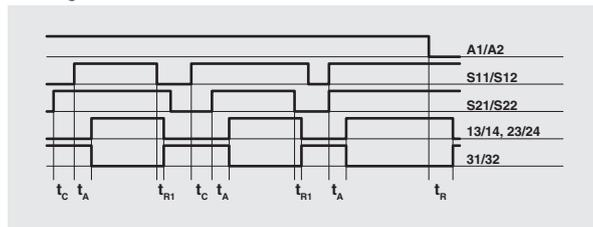

Configuration with monitored start

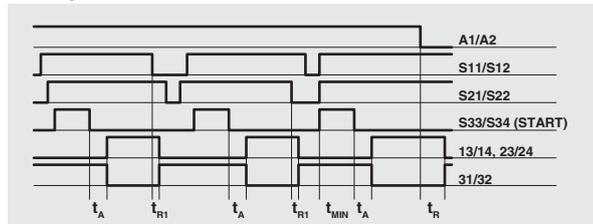

Configuration with manual start

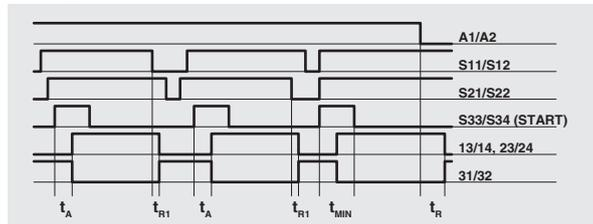

- Legend:
- $t_{MIN}$ : Min. duration of start impulse
  - $t_c$ : simultaneity time
  - $t_A$ : response time
  - $t_{R1}$ : release time
  - $t_r$ : release time in absence of power supply

Notes: The configurations with one channel are obtained taking into consideration the S11/S12 input only. In this case it is necessary to consider time  $t_{R1}$  referred to input S11/S12, time  $t_R$  referred to the supply, time  $t_A$  referred to input S11/S12 and to the start, and time  $t_{MIN}$  referred to the start.

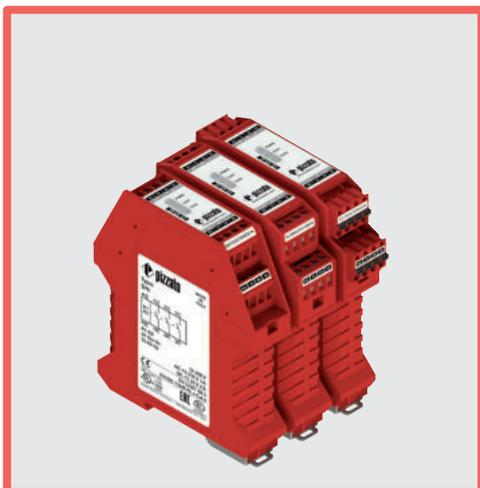

### Module for emergency stops, end position monitoring for movable guards and magnetic safety sensors

#### Main features

- For safety applications up to SIL CL 3/PL e
- Input with 1 or 2 channels
- Choice between automatic start, manual start or monitored start
- Connection of input channels of opposite potentials
- Reduced housing width of 22.5 mm
- Output contacts:  
3 NO safety contacts
- Supply voltage:  
10 ... 30 Vdc, 24 Vac/dc, 120 Vac, 230 Vac

#### Utilization categories

Alternating current: AC15 (50...60 Hz)

U<sub>e</sub> (V) 230

I<sub>e</sub> (A) 3

Direct current: DC13 (6 oper. cycles/min.)

U<sub>e</sub> (V) 24

I<sub>e</sub> (A) 4

#### Quality marks:



EC type examination certificate: IMQ CP 432 DM

UL approval: E131787

CCC approval: 2013010305640211

EAC approval: RU C-IT.YT03.B.00035/19

#### Compliance with the requirements of:

Machinery Directive 2006/42/EC,

EMC Directive 2014/30/EC,

RoHS Directive 2011/65/EU.

### Technical data

#### Housing

Polyamide housing PA 66, self-extinguishing V0 acc. to UL 94

Protection degree acc. to EN 60529:

IP40 (housing), IP20 (terminal strip)

Dimensions:

see page 317, design A

#### General data

SIL level (SIL CL) up to:

SIL CL 3 acc. to EN 62061

Performance Level (PL) up to:

PL e acc. to EN ISO 13849-1

Safety category up to:

cat. 4 acc. to EN ISO 13849-1

Safety parameters:

see page 375

Ambient temperature:

-25°C...+55°C

Mechanical endurance:

>10 million operating cycles

Electrical endurance:

>100,000 operating cycles

Pollution degree:

external 3, internal 2

Rated impulse withstand voltage (U<sub>imp</sub>):

4 kV

Rated insulation voltage (U<sub>i</sub>):

250 V

Overvoltage category:

II

#### Supply

Rated supply voltage (U<sub>n</sub>):

10 ... 30 Vdc

24 Vac/dc; 50...60 Hz

120 Vac; 50...60 Hz

230 Vac; 50...60 Hz

Max. DC residual ripple in DC:

10%

Supply voltage tolerance:

±15% of U<sub>n</sub>

Power consumption AC:

< 5 VA

Power consumption DC:

< 2 W

#### Control circuit

Protection against short circuits:

PTC resistance, I<sub>h</sub>=0.5 A

PTC times:

Response time > 100 ms, release time > 3 s

Maximum resistance per input:

≤ 50 Ω

Current per input:

< 30 mA

Min. duration of start impulse t<sub>MIN</sub>:

> 100 ms

Response time t<sub>A</sub>:

< 50 ms

Release time t<sub>R1</sub>:

< 20 ms

Release time in absence of power supply t<sub>R2</sub>:

< 70 ms

Simultaneity time t<sub>C</sub>:

unlimited

#### In compliance with standards:

EN 60204-1, EN ISO 13855, EN 1037, EN ISO 12100, EN ISO 13850, EN 60529, EN 61000-6-2, EN 61000-6-3, EN 61326-1, EN 60664-1, EN 60947-1, EN 50581, EN ISO 13849-1, EN ISO 13849-2, EN 62061, UL 508, CSA C22.2 n° 14-95, GB/T14048.5-2017

#### Output circuit

Output contacts:

3 NO safety contacts,

Contact type:

forcibly guided

Material of the contacts:

gold-plated silver alloy

Maximum switching voltage:

230/240 Vac; 300 Vdc

Max. current per contact:

6 A

Conventional free air thermal current I<sub>th</sub>:

6 A

Max. total current Σ I<sub>th</sub><sup>2</sup>:

72 A<sup>2</sup>

Minimum current:

10 mA

Contact resistance:

≤ 100 mΩ

External protection fuse:

4 A

The number and the load capacity of output contacts can be increased by using expansion modules or contactors. See pages 263-272.

### Code structure

## CS AR-02V024

Connection type	
<b>V</b>	Screw terminals
<b>M</b>	Connector with screw terminals
<b>X</b>	Connector with spring terminals

Supply voltage	
<b>024</b>	24 Vac/dc
<b>120</b>	120 Vac
<b>230</b>	230 Vac
<b>E02</b>	10 ... 30 Vdc

### Features approved by UL

Rated supply voltage (U <sub>n</sub> ):	24 Vac/dc; 50...60 Hz 120 Vac; 50...60 Hz 230 Vac; 50...60 Hz
Power consumption AC:	< 5 VA
Power consumption DC:	< 4 W
Electrical ratings:	230/240 Vac 6 A general use C300 pilot duty

#### Notes:

- Use 60 or 75°C copper (Cu) conductor and wire size No. 30-12 AWG, stranded or solid.
- The terminal tightening torque of 5-7 lb in.
- Only for 24 Vac/dc versions: supply from remote Class 2 source or limited voltage limited energy.



### Safety module CS AR-02

#### Pin assignment

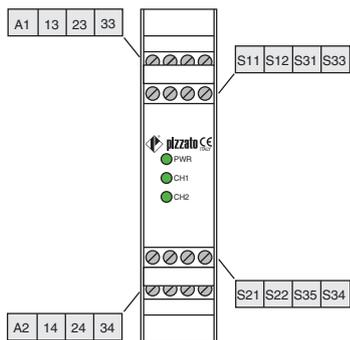

#### Internal block diagram

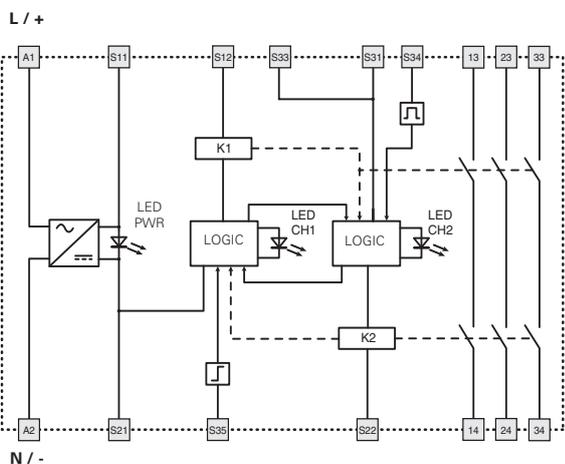

#### Function diagrams

Configuration with automatic start

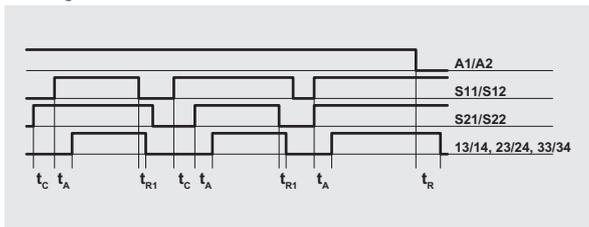

Configuration with monitored start

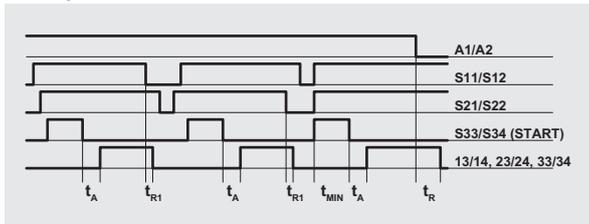

Configuration with manual start

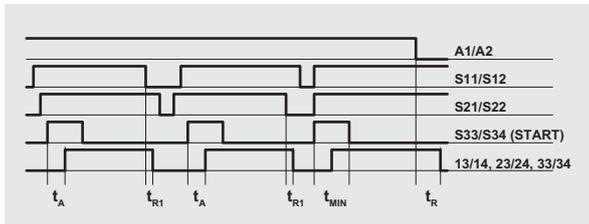

Legend: t\_MIN: Min. duration of start impulse; t\_c: simultaneity time; t\_A: response time; t\_R1: release time; t\_r: release time in absence of power supply

Notes: The configurations with one channel are obtained taking into consideration the S11/S12 input only. In this case it is necessary to consider time t\_R1 referred to input S11/S12, time t\_R referred to the supply, time t\_A referred to input S11/S12 and to the start, and time t\_MIN referred to the start.

#### Input configuration

Emergency stop circuits	
Input configuration with manual start	
1 channel	2 channels

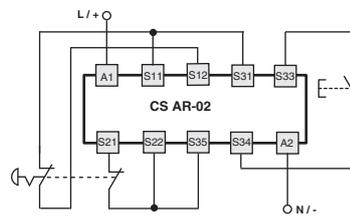
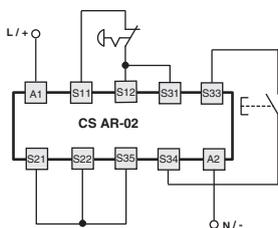

The diagram does not show the exact position of the terminals in the product

#### Automatic start

With regard to the indicated diagrams, bridge the start button between S33 and S34 in order to activate the automatic start module.

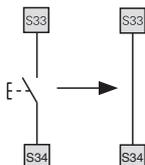

#### Monitored start

With regard to the indicated diagrams, remove the connection between S22 and S35 in order to activate the monitored start module.

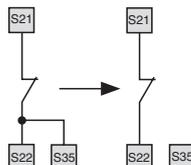

#### Monitoring of movable guards and magnetic safety sensors

The safety module can monitor emergency stop circuits, control circuits for movable guards as well as magnetic safety sensors. Replace the emergency stop contacts with switch contacts or sensor contacts. The sensors can only be used in 2-channel configuration.

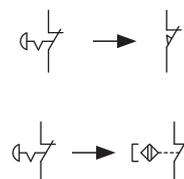

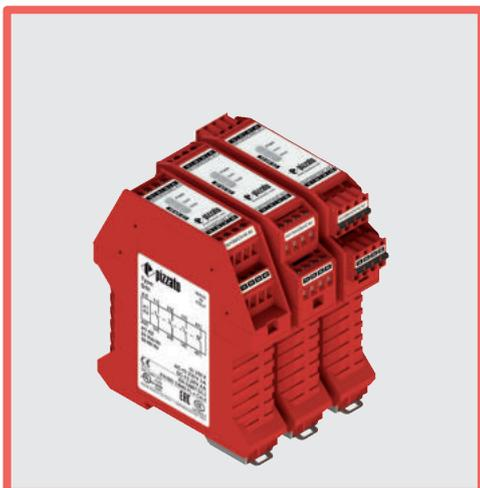

### Module for emergency stops, end position monitoring for movable guards and magnetic safety sensors

#### Main features

- For safety applications up to SIL CL 3/PL e
- Input with 1 or 2 channels
- Choice between automatic start, manual start or monitored start
- Connection of input channels of opposite potentials
- Reduced housing width of 22.5 mm
- Output contacts:  
3 NO safety contacts,  
1 NC auxiliary contact
- Supply voltage:  
24 Vac/dc, 120 Vac, 230 Vac

#### Utilization categories

Alternating current: AC15 (50...60 Hz)

U<sub>e</sub> (V) 230

I<sub>e</sub> (A) 3

Direct current: DC13 (6 oper. cycles/min.)

U<sub>e</sub> (V) 24

I<sub>e</sub> (A) 4

#### Quality marks:



EC type examination certificate: IMQ CP 432 DM

UL approval: E131787

CCC approval: 2013010305640211

EAC approval: RU C-IT.YT03.B.00035/19

#### Compliance with the requirements of:

Machinery Directive 2006/42/EC,

EMC Directive 2014/30/EC,

RoHS Directive 2011/65/EU.

### Technical data

#### Housing

Polyamide housing PA 66, self-extinguishing V0 acc. to UL 94

Protection degree acc. to EN 60529:

IP40 (housing), IP20 (terminal strip)

Dimensions:

see page 317, design A

#### General data

SIL level (SIL CL) up to:

SIL CL 3 acc. to EN 62061

Performance Level (PL) up to:

PL e acc. to EN ISO 13849-1

Safety category up to:

cat. 4 acc. to EN ISO 13849-1

Safety parameters:

see page 375

Ambient temperature:

-25°C...+55°C

Mechanical endurance:

>10 million operating cycles

Electrical endurance:

>100,000 operating cycles

Pollution degree:

external 3, internal 2

Rated impulse withstand voltage (U<sub>imp</sub>):

4 kV

Rated insulation voltage (U<sub>i</sub>):

250 V

Overvoltage category:

II

#### Supply

Rated supply voltage (U<sub>n</sub>):

24 Vac/dc; 50...60 Hz

120 Vac; 50...60 Hz

230 Vac; 50...60 Hz

Max. DC residual ripple in DC:

10%

Supply voltage tolerance:

±15% of U<sub>n</sub>

Power consumption AC:

< 5 VA

Power consumption DC:

< 2 W

#### Control circuit

Protection against short circuits:

PTC resistance, I<sub>h</sub>=0.5 A

PTC times:

Response time > 100 ms, release time > 3 s

Maximum resistance per input:

≤ 50 Ω

Current per input:

30 mA (typical)

Min. duration of start impulse t<sub>MIN</sub>:

> 100 ms

Response time t<sub>A</sub>:

< 50 ms

Release time t<sub>R1</sub>:

< 20 ms

Release time in absence of power supply t<sub>R2</sub>:

< 70 ms

Simultaneity time t<sub>C</sub>:

unlimited

#### In compliance with standards:

EN 60204-1, EN ISO 13855, EN 1037, EN ISO 12100, EN ISO 13850, EN 60529, EN 61000-6-2, EN 61000-6-3, EN 61326-1, EN 60664-1, EN 60947-1, EN 50581, EN ISO 13849-1, EN ISO 13849-2, EN 62061, UL 508, CSA C22.2 n° 14-95, GB/T14048.5-2017

#### Output circuit

Output contacts:

3 NO safety contacts

1 NC auxiliary contact

Contact type:

forcibly guided

Material of the contacts:

gold-plated silver alloy

Maximum switching voltage:

230/240 Vac; 300 Vdc

Max. current per contact:

6 A

Conventional free air thermal current I<sub>th</sub>:

6 A

Max. total current Σ I<sub>th</sub><sup>2</sup>:

64 A<sup>2</sup>

Minimum current:

10 mA

Contact resistance:

≤ 100 mΩ

External protection fuse:

4 A

The number and the load capacity of output contacts can be increased by using expansion modules or contactors. See pages 263-272.

### Code structure

## CS AR-04V024

Connection type	
<b>V</b>	Screw terminals
<b>M</b>	Connector with screw terminals
<b>X</b>	Connector with spring terminals

Supply voltage	
<b>024</b>	24 Vac/dc
<b>120</b>	120 Vac
<b>230</b>	230 Vac

### Features approved by UL

Rated supply voltage (U <sub>n</sub> ):	24 Vac/dc; 50...60 Hz 120 Vac; 50...60 Hz 230 Vac; 50...60 Hz
Power consumption AC:	< 5 VA
Power consumption DC:	< 4 W
Electrical ratings:	230/240 Vac 6 A general use C300 pilot duty

#### Notes:

- Use 60 or 75°C copper (Cu) conductor and wire size No. 30-12 AWG, stranded or solid.
- The terminal tightening torque of 5-7 lb in.
- Only for 24 Vac/dc versions: supply from remote Class 2 source or limited voltage limited energy.



### Safety module CS AR-04

#### Pin assignment

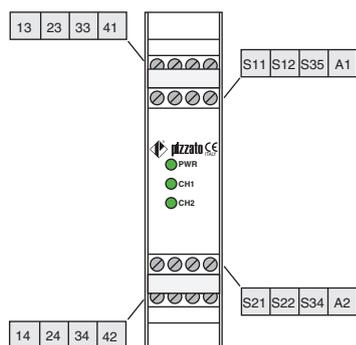

#### Internal block diagram

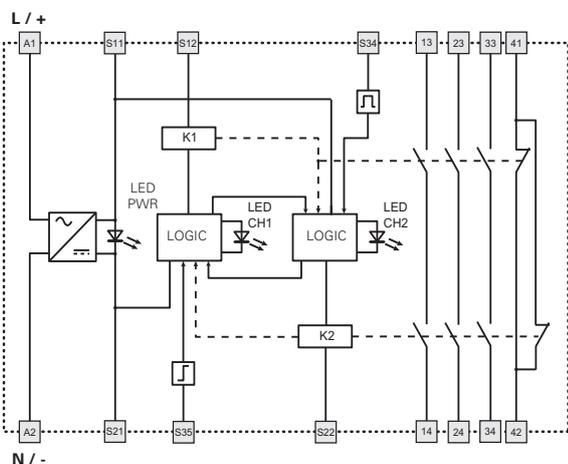

#### Input configuration

Emergency stop circuits	
Input configuration with manual start	
1 channel	2 channels

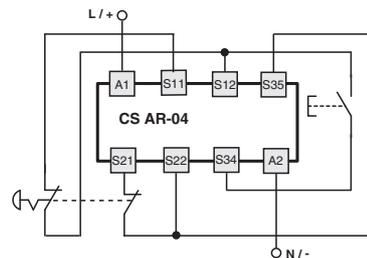
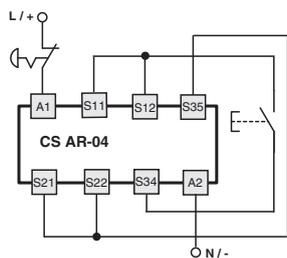

The diagram does not show the exact position of the terminals in the product

#### Automatic start

With regard to the indicated diagrams, bridge the start button between S12 and S34 in order to activate the automatic start module.

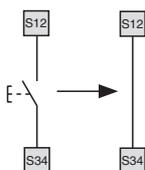

#### Monitored start

With regard to the indicated diagrams, remove the connection between S22 and S35 in order to activate the monitored start module.

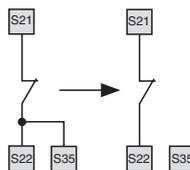

#### Monitoring of movable guards and magnetic safety sensors

The safety module can monitor emergency stop circuits, control circuits for movable guards as well as magnetic safety sensors. Replace the emergency stop contacts with switch contacts or sensor contacts. The sensors can only be used in 2-channel configuration.

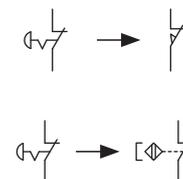

#### Function diagrams

Configuration with automatic start

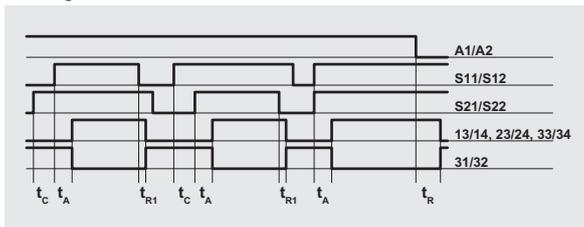

Configuration with monitored start

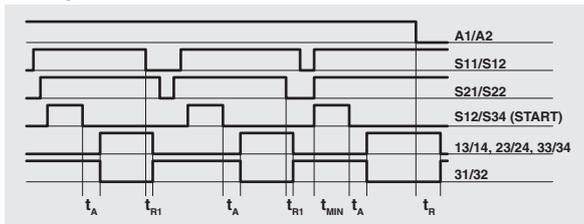

Configuration with manual start

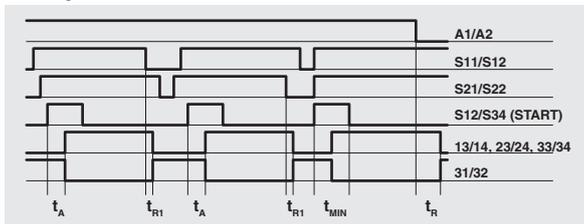

#### Legend:

- $t_{MIN}$ : Min. duration of start impulse
- $t_c$ : simultaneity time
- $t_A$ : response time
- $t_R$ : release time
- $t_{R1}$ : release time in absence of power supply

#### Notes:

The configurations with one channel are obtained taking into consideration only the effect of the S11/S12 input on the supply. In this case it is necessary to consider time  $t_{R1}$  referred to input S11/S12, time  $t_R$  referred to the supply, time  $t_A$  referred to input S11/S12 and to the start, and time  $t_{MIN}$ .



### Module for emergency stops, end position monitoring for movable guards, OSSD semiconductor outputs and magnetic safety sensors

#### Main features

- For safety applications up to SIL CL 3/PL e
- Input with 1 or 2 channels
- Choice between automatic start, manual start (CS AR-05 only) or monitored start (CS AR-06 only)
- Can be connected to OSSD semiconductor outputs, to electromechanical contacts or to magnetic safety sensors
- Output contacts:  
3 NO safety contacts,  
1 NC auxiliary contact
- Supply voltage:  
24 Vac/dc, 120 Vac, 230 Vac

#### Utilization categories

Alternating current: AC15 (50...60 Hz)

U<sub>e</sub> (V) 230

I<sub>e</sub> (A) 3

Direct current: DC13 (6 oper. cycles/min.)

U<sub>e</sub> (V) 24

I<sub>e</sub> (A) 4

#### Quality marks:



EC type examination certificate: IMQ CP 432 DM

UL approval: E131787

CCC approval: 2013010305640211

EAC approval: RU C-IT.YT03.B.00035/19

#### Compliance with the requirements of:

Machinery Directive 2006/42/EC,

EMC Directive 2014/30/EC,

RoHS Directive 2011/65/EU.

## Technical data

### Housing

Polyamide housing PA 66, self-extinguishing V0 acc. to UL 94

Protection degree acc. to EN 60529:

IP40 (housing), IP20 (terminal strip)

Dimensions:

see page 317, design A

### General data

SIL level (SIL CL) up to:

SIL CL 3 acc. to EN 62061

Performance Level (PL) up to:

PL e acc. to EN ISO 13849-1

Safety category up to:

cat. 4 acc. to EN ISO 13849-1

Safety parameters:

see page 375

Ambient temperature:

-25°C...+55°C

Mechanical endurance:

>10 million operating cycles

Electrical endurance:

>100,000 operating cycles

Pollution degree:

external 3, internal 2

Rated impulse withstand voltage (U<sub>imp</sub>):

4 kV

Rated insulation voltage (U<sub>i</sub>):

250 V

Overvoltage category:

II

### Supply

Rated supply voltage (U<sub>n</sub>):

24 Vac/dc; 50...60 Hz

120 Vac; 50...60 Hz

230 Vac; 50...60 Hz

Max. DC residual ripple in DC:

10%

Supply voltage tolerance:

±15% of U<sub>n</sub>

Power consumption AC:

< 5 VA

Power consumption DC:

< 2 W

### Control circuit

Protection against short circuits:

PTC resistance, I<sub>h</sub>=0.5 A

PTC times:

Response time > 100 ms, release time > 3 s

Maximum resistance per input:

≤ 50 Ω

Current per input:

< 30 mA

Min. duration of start impulse t<sub>MIN</sub>:

> 250 ms

Response time t<sub>A</sub>:

< 200 ms

Release time t<sub>R1</sub>:

< 15 ms

Release time in absence of power supply t<sub>R</sub>:

< 70 ms

Simultaneity time t<sub>c</sub>:

unlimited

### In compliance with standards:

EN 60204-1, EN ISO 13855, EN 1037, EN ISO 12100, EN ISO 13850, EN 60529, EN 61000-6-2, EN 61000-6-3, EN 61326-1, EN 60664-1, EN 60947-1, EN 50581, EN ISO 13849-1, EN ISO 13849-2, EN 62061, UL 508, CSA C22.2 n° 14-95, GB/T14048.5-2017

### Output circuit

Output contacts:

3 NO safety contacts

1 NC auxiliary contact

forcibly guided

gold-plated silver alloy

230/240 Vac; 300 Vdc

6 A

Contact type:

Material of the contacts:

Maximum switching voltage:

Max. current per contact:

Conventional free air thermal current I<sub>th</sub>:

Max. total current Σ I<sub>th</sub><sup>2</sup>:

Minimum current:

Contact resistance:

External protection fuse:

6 A

64 A<sup>2</sup>

10 mA

≤ 100 mΩ

4 A

The number and the load capacity of output contacts can be increased by using expansion modules or contactors. See pages 263-272.

## Code structure

# CS AR-05V024

#### Start mode

**05** manual or automatic start

**06** monitored start

#### Connection type

**V** Screw terminals

**M** Connector with screw terminals

**X** Connector with spring terminals

#### Supply voltage

**024** 24 Vac/dc

**120** 120 Vac

**230** 230 Vac

## Features approved by UL

Rated supply voltage (U<sub>n</sub>):

24 Vac/dc; 50...60 Hz

120 Vac; 50...60 Hz

230 Vac; 50...60 Hz

Power consumption AC:

< 5 VA

Power consumption DC:

< 4 W

Electrical ratings:

230/240 Vac

6 A general use

C300 pilot duty

Notes:  
- Use 60 or 75°C copper (Cu) conductor and wire size No. 30-12 AWG, stranded or solid.  
- The terminal tightening torque of 5-7 lb in.  
- Only for 24 Vac/dc versions: supply from remote Class 2 source or limited voltage limited energy.





### Module for emergency stops and end position monitoring for movable guards

#### Main features

- For safety applications up to SIL CL 3/PL e
- Input with 1 or 2 channels
- Choice between automatic start, manual start or monitored start
- Connection of input channels of opposite potentials
- Reduced housing width of 22.5 mm
- Output contacts:  
4 NO safety contacts,  
1 NC auxiliary contact
- Supply voltage:  
24 Vac/dc

#### Utilization categories

Alternating current: AC15 (50...60 Hz)

U<sub>e</sub> (V) 230

I<sub>e</sub> (A) 3

Direct current: DC13 (6 oper. cycles/min.)

U<sub>e</sub> (V) 24

I<sub>e</sub> (A) 4

#### Quality marks:



EC type examination certificate: IMQ CP 432 DM

UL approval: E131787

CCC approval: 2013010305640211

EAC approval: RU C-IT.YT03.B.00035/19

#### Compliance with the requirements of:

Machinery Directive 2006/42/EC,

EMC Directive 2014/30/EC,

RoHS Directive 2011/65/EU.

### Technical data

#### Housing

Polyamide housing PA 66, self-extinguishing V0 acc. to UL 94

Protection degree acc. to EN 60529:

IP40 (housing), IP20 (terminal strip)

Dimensions:

see page 317, design B

#### General data

SIL level (SIL CL) up to:

SIL CL 3 acc. to EN 62061

Performance Level (PL) up to:

PL e acc. to EN ISO 13849-1

Safety category up to:

cat. 4 acc. to EN ISO 13849-1

Safety parameters:

see page 375

Ambient temperature:

-25°C...+55°C

Mechanical endurance:

> 10 million operating cycles

Electrical endurance:

> 100,000 operating cycles

Pollution degree:

external 3, internal 2

Rated impulse withstand voltage (U<sub>imp</sub>):

4 kV

Rated insulation voltage (U<sub>i</sub>):

250 V

Overvoltage category:

II

#### Supply

Rated supply voltage (U<sub>n</sub>):

24 Vac/dc; 50...60 Hz

Max. DC residual ripple in DC:

10%

Supply voltage tolerance:

±15% of U<sub>n</sub>

Power consumption AC:

< 5 VA

Power consumption DC:

< 2 W

#### Control circuit

Protection against short circuits:

PTC resistance, I<sub>h</sub>=0.5 A

PTC times:

Response time > 100 ms, release time > 3 s

Maximum resistance per input:

≤ 50 Ω

Current per input:

30 mA (typical)

Min. duration of start impulse t<sub>MIN</sub>:

> 100 ms

Response time t<sub>A</sub>:

< 70 ms

Release time t<sub>R1</sub>:

< 40 ms

Release time in absence of power supply t<sub>R</sub>:

< 80 ms

Simultaneity time t<sub>c</sub>:

unlimited

#### In compliance with standards:

EN 60204-1, EN ISO 13855, EN 1037, EN ISO 12100, EN ISO 13850, EN 60529, EN 61000-6-2, EN 61000-6-3, EN 61326-1, EN 60664-1, EN 60947-1, EN 50581, EN ISO 13849-1, EN ISO 13849-2, EN 62061, UL 508, CSA C22.2 n° 14-95, GB/T14048.5-2017

#### Output circuit

Output contacts:

4 NO safety contacts

1 NC auxiliary contact

Contact type:

forcibly guided

Material of the contacts:

gold-plated silver alloy

Maximum switching voltage:

230/240 Vac; 220 Vdc

Max. current per contact:

6 A

Conventional free air thermal current I<sub>th</sub>:

6 A

Max. total current Σ I<sub>th</sub><sup>2</sup>:

72 A<sup>2</sup>

Minimum current:

10 mA

Contact resistance:

≤ 100 mΩ

External protection fuse:

4 A

The number and the load capacity of output contacts can be increased by using expansion modules or contactors. See pages 263-272.

### Code structure

## CS AR-07M024

#### Connection type

**M** Connector with screw terminals

**X** Connector with spring terminals

#### Supply voltage

**024** 24 Vac/dc

### Features approved by UL

Rated supply voltage (U<sub>n</sub>): 24 Vac/dc; 50...60 Hz

Power consumption AC: < 5 VA

Power consumption DC: < 4 W

Electrical ratings: 230/240 Vac

6 A general use

C300 pilot duty

#### Notes:

- Use 60 or 75°C copper (Cu) conductor and wire size No. 30-12 AWG, stranded or solid.

- The terminal tightening torque of 5-7 lb in.

- Only for 24 Vac/dc versions: supply from remote Class 2 source or limited voltage limited energy.





# Safety module CS AR-07

## Pin assignment

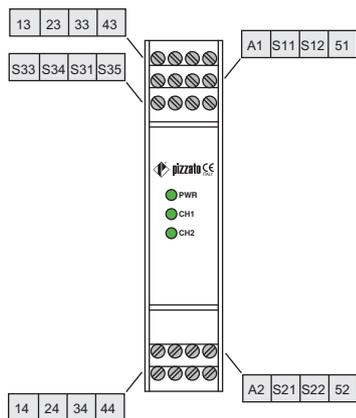

## Internal block diagram

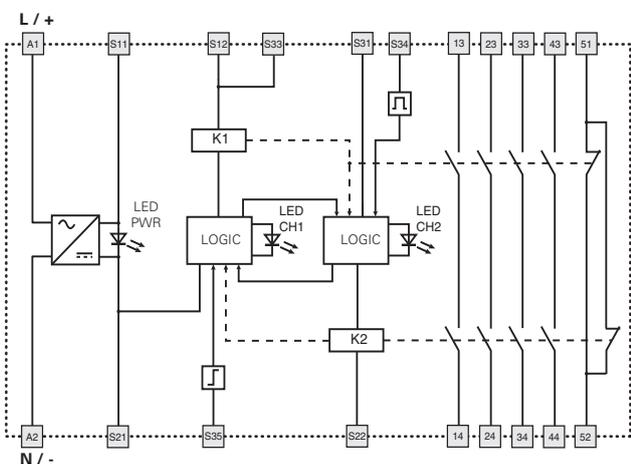

## Input configuration

Emergency stop circuits	
Input configuration with manual start	
1 channel	2 channels

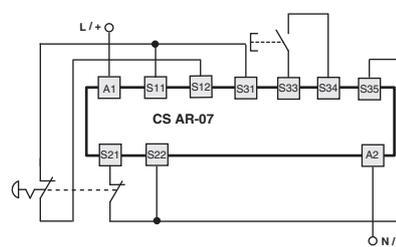
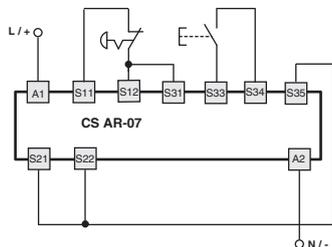

The diagram does not show the exact position of the terminals in the product

### Automatic start

With regard to the indicated diagrams, bridge the start button between S33 and S34 in order to activate the automatic start module.

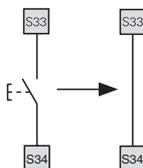

### Monitored start

With regard to the indicated diagrams, remove the connection between S22 and S35 in order to activate the monitored start module.

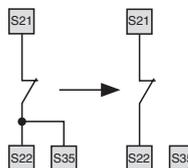

### Movable guard monitoring

The safety module can monitor emergency stop circuits and control circuits for movable guards. Replace the emergency stop contacts with the switch contacts.

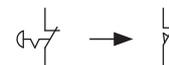

## Function diagrams

Configuration with automatic start

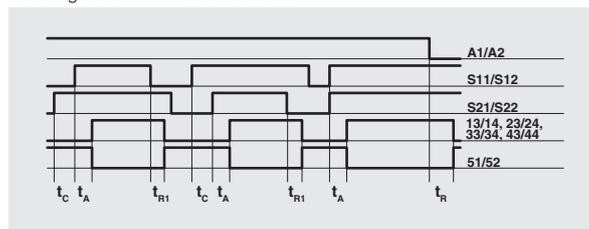

Configuration with monitored start

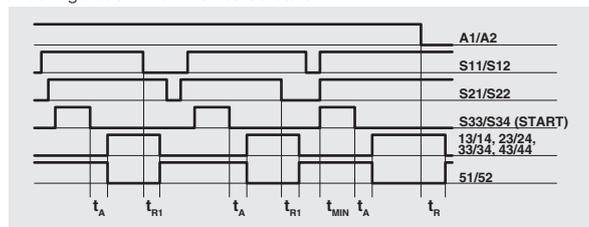

Configuration with manual start

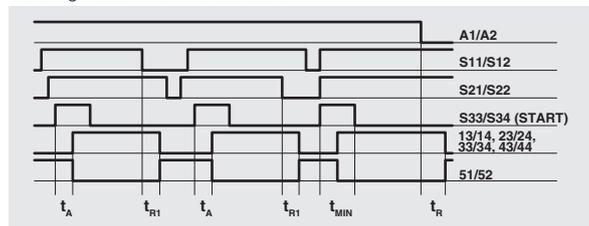

### Legend:

- $t_{MIN}$ : Min. duration of start impulse
- $t_C$ : simultaneity time
- $t_A$ : response time
- $t_{R1}$ : release time
- $t_R$ : release time in absence of power supply

### Notes:

The configurations with one channel are obtained taking into consideration the S11/S12 input only. In this case it is necessary to consider time  $t_{R1}$  referred to input S11/S12, time  $t_R$  referred to the supply, time  $t_A$  referred to input S11/S12 and to the start, and time  $t_{MIN}$  referred to the start.



### Module for emergency stops, end position monitoring for movable guards, OSSD semiconductor outputs and magnetic safety sensors

#### Main features

- For safety applications up to SIL CL 3/PL e
- Input with 1 or 2 channels
- Choice between automatic start, manual start or monitored start
- Can be connected to OSSD semiconductor outputs, to electromechanical contacts or to magnetic safety sensors
- Output contacts:  
2 NO safety contacts
- Supply voltage:  
12 Vdc, 24 Vac/dc, 120 Vac, 230 Vac
- Possibility of parallel reset of several modules

#### Utilization categories

Alternating current: AC15 (50...60 Hz)

U<sub>e</sub> (V) 230

I<sub>e</sub> (A) 3

Direct current: DC13 (6 oper. cycles/min.)

U<sub>e</sub> (V) 24

I<sub>e</sub> (A) 4

#### Quality marks:



EC type examination certificate: IMQ CP 432 DM

UL approval: E131787

CCC approval: 2013010305640211

TÜV SÜD approval: Z10 18 05 75157 018

EAC approval: RU C-IT.YT03.B.00035/19

#### Compliance with the requirements of:

Machinery Directive 2006/42/EC,

EMC Directive 2014/30/EC,

RoHS Directive 2011/65/EU.

#### Code structure

## CS AR-08V024

Connection type	
<b>V</b>	Screw terminals
<b>M</b>	Connector with screw terminals
<b>X</b>	Connector with spring terminals

Supply voltage	
<b>U12</b>	12 Vdc
<b>024</b>	24 Vac/dc
<b>120</b>	120 Vac
<b>230</b>	230 Vac

#### Technical data

##### Housing

Polyamide housing PA 66, self-extinguishing V0 acc. to UL 94

Protection degree acc. to EN 60529:

IP40 (housing), IP20 (terminal strip)

Dimensions:

see page 317, design A

##### General data

SIL level (SIL CL) up to:

SIL CL 3 acc. to EN 62061

Performance Level (PL) up to:

PL e acc. to EN ISO 13849-1

Safety category up to:

cat. 4 acc. to EN ISO 13849-1

Safety parameters:

see page 375

Ambient temperature:

-25°C...+55°C

Mechanical endurance:

>10 million operating cycles

Electrical endurance:

>100,000 operating cycles

Pollution degree:

external 3, internal 2

Rated impulse withstand voltage (U<sub>imp</sub>):

4 kV

Rated insulation voltage (U<sub>i</sub>):

250 V

Overvoltage category:

II

##### Supply

Rated supply voltage (U<sub>n</sub>):

12 Vdc  
24 Vac/dc; 50...60 Hz  
120 Vac; 50...60 Hz  
230 Vac; 50...60 Hz

Max. DC residual ripple in DC:

10%

Supply voltage tolerance

±15% of U<sub>n</sub>

24 Vac/dc, 120 Vac, 230 Vac:

Supply voltage tolerance 12 Vdc:

-10% ... +15% of U<sub>n</sub>

Power consumption AC:

< 5 VA

Power consumption DC:

< 2 W

##### Control circuit

Protection against short circuits:

PTC resistance, I<sub>h</sub>=0.5 A

PTC times:

Response time > 100 ms, release time > 3 s

Maximum resistance per input:

≤ 50 Ω (15 Ω)\*

Current per input:

30 mA (70 mA)\* (typical)

Min. duration of start impulse t<sub>MIN</sub>:

> 200 ms (100 ms)\*

Response time t<sub>A</sub>:

< 150 ms (220 ms)\*

Release time t<sub>R1</sub>:

< 20 ms (15 ms)\*

Release time in absence of power supply t<sub>R2</sub>:

< 200 ms (50 ms)\*

Simultaneity time t<sub>c</sub>:

unlimited

\* Version CS AR-08•U12

#### In compliance with standards:

EN 60204-1, EN ISO 13855, EN 1037, EN ISO 12100, EN ISO 13850, EN 60529, EN 61000-6-2, EN 61000-6-3, EN 61326-1, EN 60664-1, EN 60947-1, EN 60947-5-3, EN 61508-1, EN 61508-2, EN 61508-4, EN 50581, EN ISO 13849-1, EN ISO 13849-2, EN 62061, UL 508, CSA C22.2 n° 14-95, GB/T14048.5-2017

#### Output circuit

Output contacts:

2 NO safety contacts,

Contact type:

forcibly guided

Material of the contacts:

gold-plated silver alloy

Maximum switching voltage:

230/240 Vac; 300 Vdc

Max. current per contact:

6 A

Conventional free air thermal current I<sub>th</sub>:

6 A

Max. total current Σ I<sub>th</sub><sup>2</sup>:

36 A<sup>2</sup>

Minimum current:

10 mA

Contact resistance:

≤ 100 mΩ

External protection fuse:

4 A

The number and the load capacity of output contacts can be increased by using expansion modules or contactors. See pages 263-272.

#### Features approved by UL

Rated supply voltage (U<sub>n</sub>): 24 Vac/dc; 50...60 Hz, 120 Vac; 50...60 Hz  
230 Vac; 50...60 Hz

Power consumption AC: < 5 VA

Power consumption DC: < 4 W

Electrical ratings: 230/240 Vac, 6 A general use, C300 pilot duty

Notes:

- Use 60 or 75°C copper (Cu) conductor and wire size No. 30-12 AWG, stranded or solid.

- The terminal tightening torque of 5-7 lb in.

- Only for 24 Vac/dc versions: supply from remote Class 2 source or limited voltage limited energy.

#### Features approved by TÜV SÜD

Rated supply voltage (U<sub>n</sub>): 24 Vac/dc ± 15%,  
120 Vac ± 15%, 230 Vac ± 15%

Power consumption: 5 VA max AC, 2 W max DC

Rated operating current (max.): 4 A

Maximum switching load (max.): 1380 VA

Ambient temperature: -25°C ... +55°C

Storage temperature: -25°C ... +70°C

Protection degree: IP40 (housing), IP20 (terminal strip)

In compliance with standards: 2006/42/EC Machinery Directive,

EN ISO 13849-1:2015 (fino a Cat. 4 PL e), EN 60947-5-3:2013,

EN 61508-1:2010 (fino a SIL 3), EN 61508-2:2010 (fino a SIL 3),

EN 61508-4:2010 (fino a SIL 3), EN 62061:2005/A2:2015 (fino a SIL CL 3)



# Safety module CS AR-08

## Pin assignment

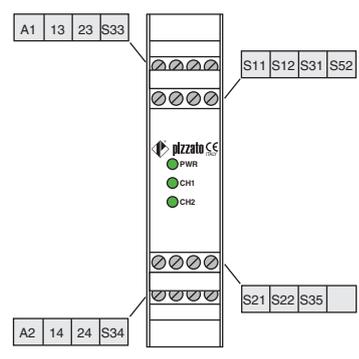

## Internal block diagram

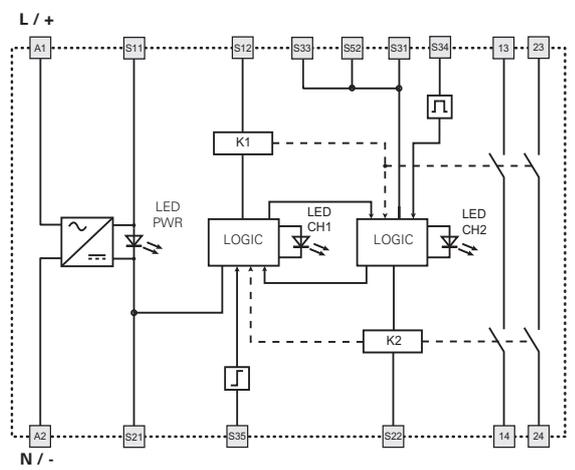

## Input configuration

### OSSD semiconductor outputs (e.g. ST, NS, NG series or light barriers)

#### Input configuration with manual start

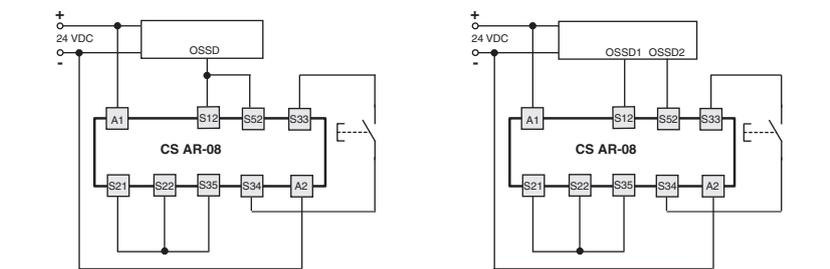

### Emergency stop circuits

#### Input configuration with manual start

#### 1 channel 2 channels

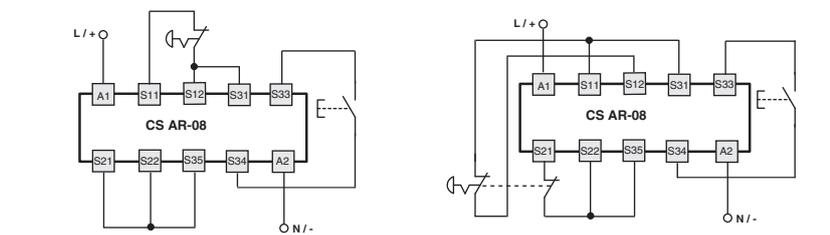

The diagram does not show the exact position of the terminals in the product

## Function diagrams

### Configuration with automatic start

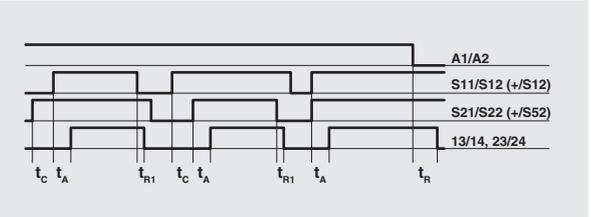

### Configuration with monitored start

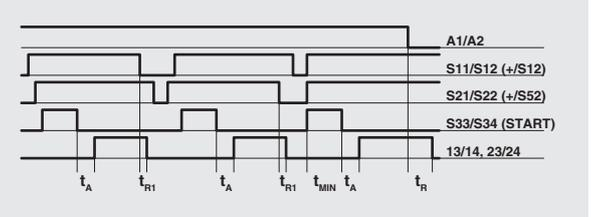

### Configuration with manual start

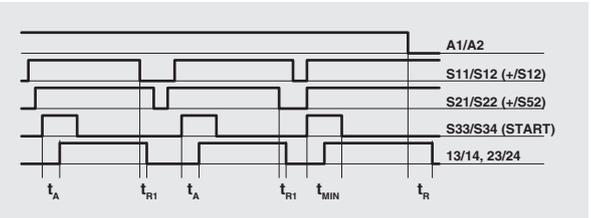

Legend:  
 $t_{MIN}$ : Min. duration of start impulse  
 $t_c$ : simultaneity time  
 $t_A$ : response time  
 $t_{R1}$ : release time  
 $t_R$ : release time in absence of power supply

Notes:  
 The configurations with one channel are obtained taking into consideration the CH1 input only. In this case it is necessary to consider time  $t_{R1}$  referred to input CH1, time  $t_A$  referred to the supply, time  $t_A$  referred to input CH1 and to the start, and time  $t_{MIN}$  referred to the start.

### Automatic start

With regard to the indicated diagrams, bridge the start button between S33 and S34 in order to activate the automatic start module.

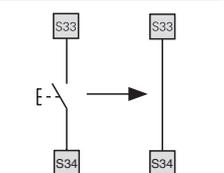

### Monitored start

With regard to the indicated diagrams, remove the connection between S22 and S35 in order to activate the monitored start module.

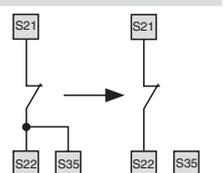

### Monitoring of movable guards and magnetic safety sensors

The safety module can monitor emergency stop circuits, control circuits for movable guards as well as magnetic safety sensors. Replace the emergency stop contacts with switch contacts or sensor contacts. The sensors can only be used in 2-channel configuration.

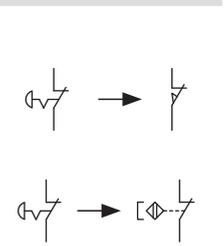

Application examples See page 273



### Module for emergency stops and end position monitoring for movable guards

#### Main features

- For safety applications up to SIL CL 3/PL e
- Input with 1 or 2 channels
- Choice between automatic start, manual start (CS AR-20 only) or monitored start (CS AR-21 only)
- Reduced housing width of 22.5 mm
- 2 NO safety contacts
- Supply voltage: 24 Vac/dc, 120 Vac, 230 Vac

#### Utilization categories

Alternating current: AC15 (50...60 Hz)

U<sub>e</sub> (V) 230

I<sub>e</sub> (A) 3

Direct current: DC13 (6 oper. cycles/min.)

U<sub>e</sub> (V) 24

I<sub>e</sub> (A) 4

#### Quality marks:



EC type examination certificate: IMQ CP 432 DM

UL approval: E131787

CCC approval: 2013010305640211

EAC approval: RU C-IT.YT03.B.00035/19

#### Compliance with the requirements of:

Machinery Directive 2006/42/EC,

EMC Directive 2014/30/EC,

RoHS Directive 2011/65/EU.

#### Technical data

##### Housing

Polyamide housing PA 66, self-extinguishing V0 acc. to UL 94

Protection degree acc. to EN 60529:

IP40 (housing), IP20 (terminal strip)

Dimensions:

see page 317, design A

##### General data

SIL level (SIL CL) up to:

SIL CL 3 acc. to EN 62061

Performance Level (PL) up to:

PL e acc. to EN ISO 13849-1

Safety category up to:

cat. 3 acc. to EN ISO 13849-1

Safety parameters:

see page 375

Ambient temperature:

-25°C...+55°C

Mechanical endurance:

>10 million operating cycles

Electrical endurance:

>100,000 operating cycles

Pollution degree:

external 3, internal 2

Rated impulse withstand voltage (U<sub>imp</sub>):

4 kV

Rated insulation voltage (U<sub>i</sub>):

250 V

Overvoltage category:

II

##### Supply

Rated supply voltage (U<sub>n</sub>):

24 Vac/dc; 50...60 Hz

120 Vac; 50...60 Hz

230 Vac; 50...60 Hz

Max. DC residual ripple in DC:

10%

Supply voltage tolerance:

±15% of U<sub>n</sub>

Power consumption AC:

< 5 VA

Power consumption DC:

< 2 W

##### Control circuit

Protection against short circuits:

PTC resistance, I<sub>h</sub>=0.5 A

PTC times:

Response time > 100 ms, release time > 3 s

Maximum resistance per input:

≤ 50 Ω

Current per input:

70 mA (typical)

Min. duration of start impulse t<sub>MIN</sub>:

> 100 ms

Response time t<sub>A</sub>:

< 50 ms

Release time in absence of power supply t<sub>R</sub>:

< 100 ms

Simultaneity time t<sub>C</sub>:

unlimited

##### In compliance with standards:

EN 60204-1, EN ISO 13855, EN 1037, EN ISO 12100, EN ISO 13850, EN 60529, EN 61000-6-2, EN 61000-6-3, EN 61326-1, EN 60664-1, EN 60947-1, EN 50581, EN ISO 13849-1, EN ISO 13849-2, EN 62061, UL 508, CSA C22.2 n° 14-95, GB/T14048.5-2017

##### Output circuit

Output contacts:

2 NO safety contacts

Contact type:

forcibly guided

Material of the contacts:

gold-plated silver alloy

Maximum switching voltage:

230/240 Vac; 300 Vdc

Max. current per contact:

6 A

Conventional free air thermal current I<sub>th</sub>:

6 A

Max. total current Σ I<sub>th</sub><sup>2</sup>:

36 A<sup>2</sup>

Minimum current:

10 mA

Contact resistance:

≤ 100 mΩ

External protection fuse:

4 A

The number and the load capacity of output contacts can be increased by using expansion modules or contactors. See pages 263-272.

#### Code structure

## CS AR-20V024

#### Start mode

**20** manual or automatic start

**21** monitored start

#### Connection type

**V** Screw terminals

**M** Connector with screw terminals

**X** Connector with spring terminals

#### Supply voltage

**024** 24 Vac/dc

**120** 120 Vac

**230** 230 Vac

#### Features approved by UL

Rated supply voltage (U<sub>n</sub>): 24 Vac/dc; 50...60 Hz

120 Vac; 50...60 Hz

230 Vac; 50...60 Hz

Power consumption AC: < 5 VA

Power consumption DC: < 4 W

Electrical ratings: 230/240 Vac

6 A general use

C300 pilot duty

#### Notes:

- Use 60 or 75°C copper (Cu) conductor and wire size No. 30-12 AWG, stranded or solid.

- The terminal tightening torque of 5-7 lb in.

- Only for 24 Vac/dc versions: supply from remote Class 2 source or limited voltage limited energy.



# Safety module CS AR-20 / CS AR-21

## Pin assignment

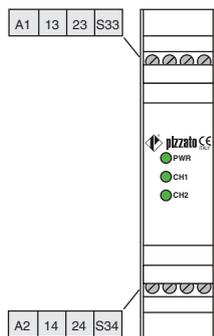

## Internal block diagram

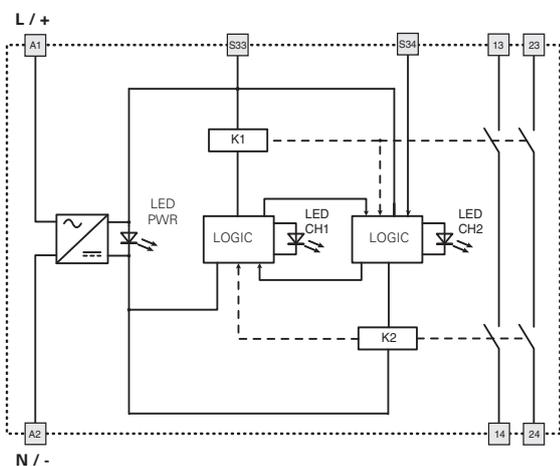

## Function diagrams

Configuration with automatic start (CS AR-20 only)

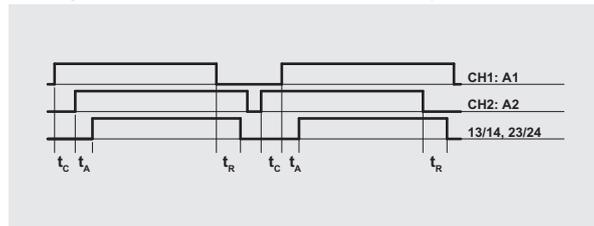

Configuration with monitored start (CS AR-21 only)

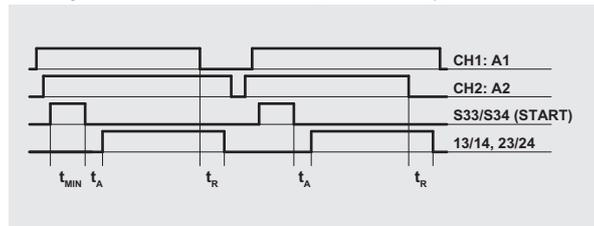

Configuration with manual start (CS AR-20 only)

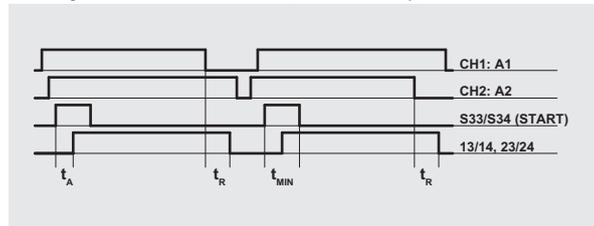

Legend:  
 $t_{MIN}$ : Min. duration of start impulse       $t_A$ : response time  
 $t_c$ : simultaneity time                               $t_R$ : release time in absence of power supply

Notes:  
 The configurations with one channel are obtained taking into consideration the CH1:A1 input only. In this case it is necessary to consider time  $t_R$  referred to input CH1:A1, time  $t_A$  referred to input CH1:A1 and to the start, and time  $t_{MIN}$  referred to the start.

## Input configuration

Emergency stop circuits	
Input configuration with manual start	
1 channel	2 channels

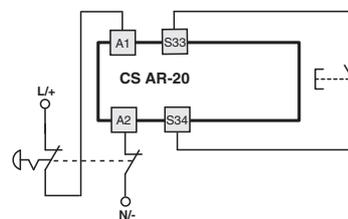
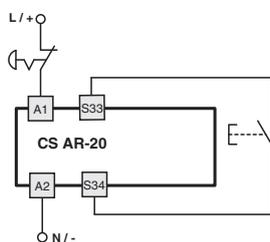

The diagram does not show the exact position of the terminals in the product

### Automatic start

With regard to the indicated diagrams, bridge the start button between S33 and S34 in order to activate the automatic start module.

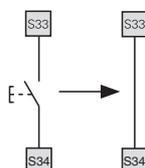

### Monitored start

Use module CS AR-21 with the circuit diagrams for manual start.

### Movable guard monitoring

The safety module can monitor emergency stop circuits and control circuits for movable guards. Replace the emergency stop contacts with the switch contacts.

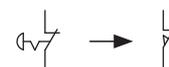

Application examples See page 273



### Module for emergency stops and end position monitoring for movable guards

#### Main features

- For safety applications up to SIL CL 3/PL e
- Input with 1 or 2 channels
- Choice between automatic start, manual start (CS AR-22 only) or monitored start (CS AR-23 only)
- Reduced housing width of 22.5 mm
- 3 NO safety contacts, 1 NC auxiliary contact
- Supply voltage: 24 Vac/dc, 120 Vac, 230 Vac

#### Utilization categories

Alternating current: AC15 (50...60 Hz)

U<sub>e</sub> (V) 230

I<sub>e</sub> (A) 3

Direct current: DC13 (6 oper. cycles/min.)

U<sub>e</sub> (V) 24

I<sub>e</sub> (A) 4

#### Quality marks:



EC type examination certificate: IMQ CP 432 DM

UL approval: E131787

CCC approval: 2013010305640211

EAC approval: RU C-IT.YT03.B.00035/19

#### Compliance with the requirements of:

Machinery Directive 2006/42/EC,

EMC Directive 2014/30/EC,

RoHS Directive 2011/65/EU.

#### Technical data

##### Housing

Polyamide housing PA 66, self-extinguishing V0 acc. to UL 94

Protection degree acc. to EN 60529:

IP40 (housing), IP20 (terminal strip)

Dimensions:

see page 317, design A

##### General data

SIL level (SIL CL) up to:

SIL CL 3 acc. to EN 62061

Performance Level (PL) up to:

PL e acc. to EN ISO 13849-1

Safety category up to:

cat. 3 acc. to EN ISO 13849-1

Safety parameters:

see page 375

Ambient temperature:

-25°C...+55°C

Mechanical endurance:

>10 million operating cycles

Electrical endurance:

>100,000 operating cycles

Pollution degree:

external 3, internal 2

Rated impulse withstand voltage (U<sub>imp</sub>):

4 kV

Rated insulation voltage (U<sub>i</sub>):

250 V

Overvoltage category:

II

##### Supply

Rated supply voltage (U<sub>n</sub>):

24 Vac/dc; 50...60 Hz

120 Vac; 50...60 Hz

230 Vac; 50...60 Hz

Max. DC residual ripple in DC:

10%

Supply voltage tolerance:

±15% of U<sub>n</sub>

Power consumption AC:

< 5 VA

Power consumption DC:

< 2 W

##### Control circuit

Protection against short circuits:

PTC resistance, I<sub>h</sub>=0.5 A

PTC times:

Response time > 100 ms, release time > 3 s

Maximum resistance per input:

≤ 50 Ω

Current per input:

70 mA (typical)

Min. duration of start impulse t<sub>MIN</sub>:

> 100 ms

Response time t<sub>A</sub>:

< 50 ms

Release time in absence of power supply t<sub>R</sub>:

< 75 ms

Simultaneity time t<sub>C</sub>:

unlimited

##### In compliance with standards:

EN 60204-1, EN ISO 13855, EN 1037, EN ISO 12100, EN ISO 13850, EN 60529, EN 61000-6-2, EN 61000-6-3, EN 61326-1, EN 60664-1, EN 60947-1, EN 50581, EN ISO 13849-1, EN ISO 13849-2, EN 62061, UL 508, CSA C22.2 n° 14-95, GB/T14048.5-2017

##### Output circuit

Output contacts:

3 NO safety contacts

1 NC auxiliary contact

forcibly guided

Contact type:

gold-plated silver alloy

Material of the contacts:

Maximum switching voltage:

230/240 Vac; 300 Vdc

Max. current per contact:

6 A

Conventional free air thermal current I<sub>th</sub>:

6 A

Max. total current Σ I<sub>th</sub><sup>2</sup>:

80 A<sup>2</sup>

Minimum current:

10 mA

Contact resistance:

≤ 100 mΩ

External protection fuse:

4 A

The number and the load capacity of output contacts can be increased by using expansion modules or contactors. See pages 263-272.

#### Code structure

## CS AR-22V024

#### Start mode

**22** manual or automatic start

**23** monitored start

#### Connection type

**V** Screw terminals

**M** Connector with screw terminals

**X** Connector with spring terminals

#### Supply voltage

**024** 24 Vac/dc

**120** 120 Vac

**230** 230 Vac

#### Features approved by UL

Rated supply voltage (U<sub>n</sub>): 24 Vac/dc; 50...60 Hz

120 Vac; 50...60 Hz

230 Vac; 50...60 Hz

Power consumption AC: < 5 VA

Power consumption DC: < 4 W

Electrical ratings: 230/240 Vac

6 A general use

C300 pilot duty

#### Notes:

- Use 60 or 75°C copper (Cu) conductor and wire size No. 30-12 AWG, stranded or solid.

- The terminal tightening torque of 5-7 lb in.

- Only for 24 Vac/dc versions: supply from remote Class 2 source or limited voltage limited energy.



### Safety module CS AR-22 / CS AR-23

#### Pin assignment

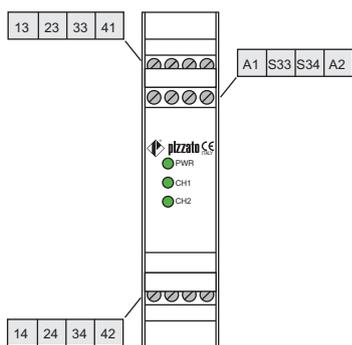

#### Internal block diagram

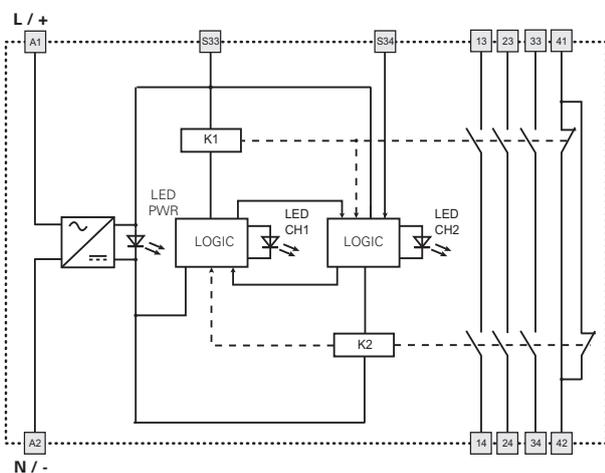

#### Input configuration

Emergency stop circuits	
Input configuration with manual start	
1 channel	2 channels

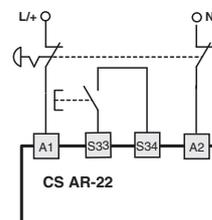
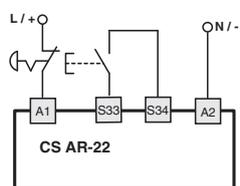

The diagram does not show the exact position of the terminals in the product

#### Automatic start

With regard to the indicated diagrams, bridge the start button between S33 and S34 in order to activate the automatic start module.

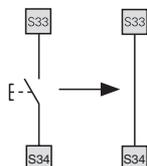

#### Monitored start

Use module CS AR-23 with the circuit diagrams for manual start.

#### Movable guard monitoring

The safety module can monitor emergency stop circuits and control circuits for movable guards. Replace the emergency stop contacts with the switch contacts.

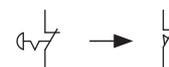

#### Function diagrams

Configuration with automatic start (CS AR-22 only)

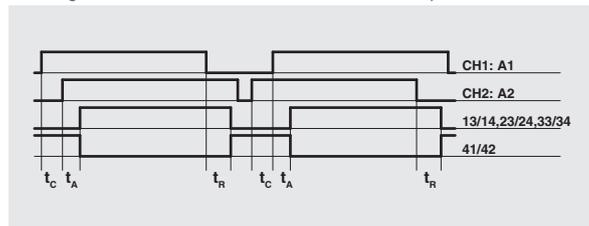

Configuration with monitored start (CS AR-23 only)

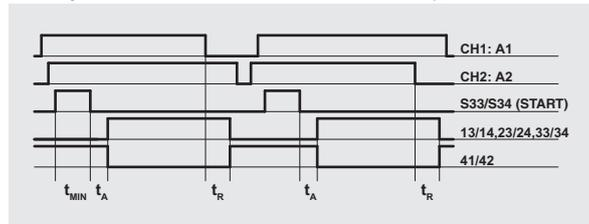

Configuration with manual start (CS AR-22 only)

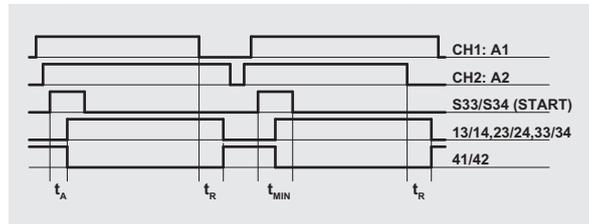

Legend:

- $t_{MIN}$ : Min. duration of start impulse
- $t_C$ : simultaneity time
- $t_A$ : response time
- $t_R$ : release time in absence of power supply

Notes:

The configurations with one channel are obtained taking into consideration the CH1:A1 input only. In this case it is necessary to consider time  $t_R$  referred to input CH1:A1, time  $t_A$  referred to input CH1:A1 and to the start, and time  $t_{MIN}$  referred to the start.



### Module for emergency stops and end position monitoring for movable guards

#### Main features

- For safety applications up to SIL CL 3/PL e
- Input with 1 or 2 channels
- Choice between automatic start, manual start (CS AR-24 only) or monitored start (CS AR-25 only)
- Reduced housing width of 22.5 mm
- 4 NO safety contacts
- 1 NC auxiliary contact
- Supply voltage: 24 Vac/dc

#### Utilization categories

Alternating current: AC15 (50...60 Hz)

U<sub>e</sub> (V) 230

I<sub>e</sub> (A) 3

Direct current: DC13 (6 oper. cycles/min.)

U<sub>e</sub> (V) 24

I<sub>e</sub> (A) 4

#### Quality marks:



EC type examination certificate: IMQ CP 432 DM

UL approval: E131787

CCC approval: 2013010305640211

EAC approval: RU C-IT.YT03.B.00035/19

#### Compliance with the requirements of:

Machinery Directive 2006/42/EC,

EMC Directive 2014/30/EC,

RoHS Directive 2011/65/EU.

### Technical data

#### Housing

Polyamide housing PA 66, self-extinguishing V0 acc. to UL 94

Protection degree acc. to EN 60529:

IP40 (housing), IP20 (terminal strip)

Dimensions:

see page 317, design A

#### General data

SIL level (SIL CL) up to:

SIL CL 3 acc. to EN 62061

Performance Level (PL) up to:

PL e acc. to EN ISO 13849-1

Safety category up to:

cat. 3 acc. to EN ISO 13849-1

Safety parameters:

see page 375

Ambient temperature:

-25°C...+55°C

Mechanical endurance:

>10 million operating cycles

Electrical endurance:

>100,000 operating cycles

Pollution degree:

external 3, internal 2

Rated impulse withstand voltage (U<sub>imp</sub>):

4 kV

Rated insulation voltage (U<sub>i</sub>):

250 V

Overvoltage category:

II

#### Supply

Rated supply voltage (U<sub>n</sub>):

24 Vac/dc; 50...60 Hz

Max. DC residual ripple in DC:

10%

Supply voltage tolerance:

±15% of U<sub>n</sub>

Power consumption AC:

< 5 VA

Power consumption DC:

< 2 W

#### Control circuit

Protection against short circuits:

PTC resistance, I<sub>h</sub>=0.5 A

PTC times:

Response time > 100 ms, release time > 3 s

Maximum resistance per input:

≤ 50 Ω

Current per input:

30 mA (typical)

Min. duration of start impulse t<sub>MIN</sub>:

> 100 ms

Response time t<sub>A</sub>:

< 85 ms

Release time t<sub>R1</sub>:

< 40 ms

Release time in absence of power supply t<sub>R2</sub>:

< 170 ms

Simultaneity time t<sub>c</sub>:

unlimited

#### In compliance with standards:

EN 60204-1, EN ISO 13855, EN 1037, EN ISO 12100, EN ISO 13850, EN 60529, EN 61000-6-2, EN 61000-6-3, EN 61326-1, EN 60664-1, EN 60947-1, EN 50581, EN ISO 13849-1, EN ISO 13849-2, EN 62061, UL 508, CSA C22.2 n° 14-95, GB/T14048.5-2017

#### Output circuit

Output contacts:

4 NO safety contacts

1 NC auxiliary contact

forcibly guided

gold-plated silver alloy

230/240 Vac; 300 Vdc

Contact type:

Material of the contacts:

Maximum switching voltage:

Max. current per contact:

Conventional free air thermal current I<sub>th</sub>:

Max. total current Σ I<sub>th</sub><sup>2</sup>:

Minimum current:

Contact resistance:

External protection fuse:

6 A

6 A

72 A<sup>2</sup>

10 mA

≤ 100 mΩ

4 A

The number and the load capacity of output contacts can be increased by using expansion modules or contactors. See pages 263-272.

### Code structure

## CS AR-24V024

#### Start mode

**24** manual or automatic start

**25** monitored start

#### Supply voltage

**024** 24 Vac/dc

#### Connection type

**V** Screw terminals

**M** Connector with screw terminals

**X** Connector with spring terminals

### Features approved by UL

Rated supply voltage (U<sub>n</sub>): 24 Vac/dc; 50...60 Hz

Power consumption AC: < 5 VA

Power consumption DC: < 4 W

Electrical ratings: 230/240 Vac

6 A general use

C300 pilot duty

#### Notes:

- Use 60 or 75°C copper (Cu) conductor and wire size No. 30-12 AWG, stranded or solid.

- The terminal tightening torque of 5-7 lb in.

- Only for 24 Vac/dc versions: supply from remote Class 2 source or limited voltage limited energy.





### Safety module CS AR-24 / CS AR-25

#### Pin assignment

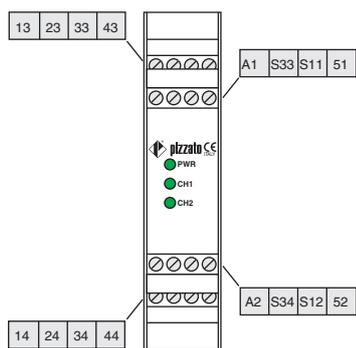

#### Function diagrams

Configuration with automatic start (CS AR-24 only)

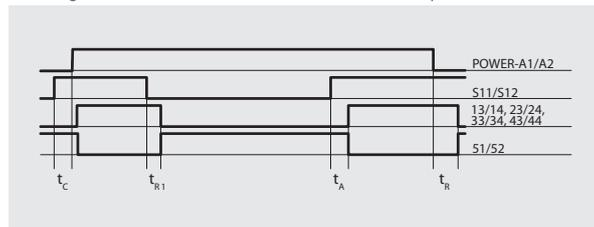

Configuration with monitored start (CS AR-25 only)

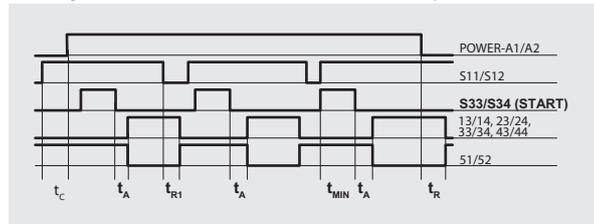

#### Internal block diagram

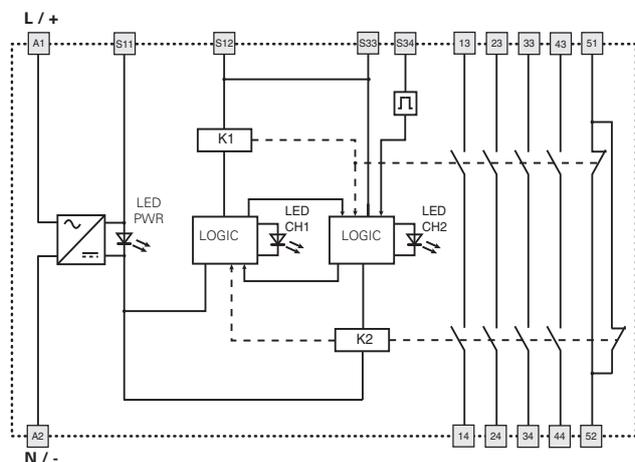

Configuration with manual start (CS AR-24 only)

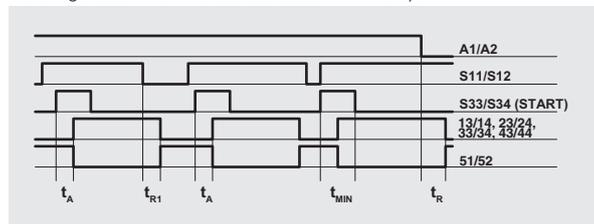

- Legend:
- $t_{MIN}$ : Min. duration of start impulse
  - $t_c$ : simultaneity time
  - $t_A$ : response time
  - $t_r$ : release time
  - $t_{r1}$ : release time in absence of power supply

Notes:  
The configurations with one channel are obtained taking into consideration the S11/S12 input only. In this case it is necessary to consider time  $t_{r1}$  referred to input S11/S12, time  $t_r$  referred to the supply, time  $t_A$  referred to input S11/S12 and to the start, and time  $t_{MIN}$  referred to the start.

#### Input configuration

Emergency stop circuits	
Input configuration with manual start	
1 channel	2 channels

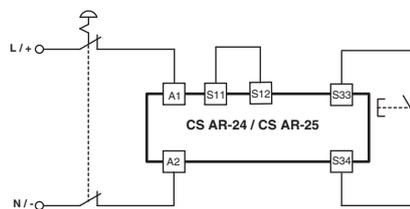
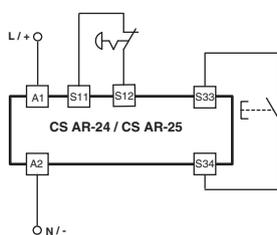

The diagram does not show the exact position of the terminals in the product

#### Automatic start

With regard to the indicated diagrams, bridge the start button between S33 and S34 in order to activate the automatic start module.

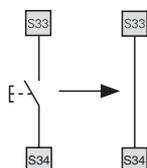

#### Monitored start

Use module CS AR-25 with the circuit diagrams for manual start.

#### Movable guard monitoring

The safety module can monitor emergency stop circuits and control circuits for movable guards. Replace the emergency stop contacts with the switch contacts.

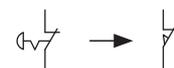



### Module for emergency stops and end position monitoring for movable guards

#### Main features

- For safety applications up to SIL CL 2/PL d
- Choice between automatic start, manual start (CS AR-40 only) or monitored start (CS AR-41 only)
- Reduced housing width of 22.5 mm
- 2 NO safety contacts
- Supply voltage: 24 Vac/dc

#### Utilization categories

Alternating current: AC15 (50...60 Hz)

U<sub>e</sub> (V) 230

I<sub>e</sub> (A) 3

Direct current: DC13 (6 oper. cycles/min.)

U<sub>e</sub> (V) 24

I<sub>e</sub> (A) 4

#### Quality marks:



EC type examination certificate: IMQ CP 432 DM

UL approval: E131787

CCC approval: 2013010305640211

EAC approval: RU C-IT.YT03.B.00035/19

#### Compliance with the requirements of:

Machinery Directive 2006/42/EC,

EMC Directive 2014/30/EC,

RoHS Directive 2011/65/EU.

#### Technical data

##### Housing

Polyamide housing PA 66, self-extinguishing V0 acc. to UL 94

Protection degree acc. to EN 60529:

IP40 (housing), IP20 (terminal strip)

Dimensions:

see page 317, design D

##### General data

SIL level (SIL CL) up to:

SIL CL 2 acc. to EN 62061

Performance Level (PL) up to:

PL d acc. to EN ISO 13849-1

Safety category up to:

cat. 2 acc. to EN ISO 13849-1

Safety parameters:

see page 375

Ambient temperature:

-25°C...+55°C

Mechanical endurance:

>10 million operating cycles

Electrical endurance:

>100,000 operating cycles

Pollution degree:

external 3, internal 2

Rated impulse withstand voltage (U<sub>imp</sub>):

4 kV

Rated insulation voltage (U<sub>i</sub>):

250 V

Overvoltage category:

II

##### Supply

Rated supply voltage (U<sub>n</sub>):

24 Vac/dc; 50...60 Hz

Max. DC residual ripple in DC:

10%

Supply voltage tolerance:

±15% of U<sub>n</sub>

Power consumption AC:

< 5 VA

Power consumption DC:

< 2 W

##### Control circuit

Protection against short circuits:

PTC resistance, I<sub>h</sub>=0.5 A

PTC times:

Response time > 100 ms, release time > 3 s

Maximum resistance per input:

≤ 50 Ω

Current per input:

70 mA (typical)

Min. duration of start impulse t<sub>MIN</sub>:

> 100 ms

Response time t<sub>A</sub>:

< 50 ms

Release time in absence of power supply t<sub>R</sub>:

< 105 ms

Simultaneity time t<sub>C</sub>:

unlimited

##### In compliance with standards:

EN 60204-1, EN ISO 13855, EN 1037, EN ISO 12100, EN ISO 13850, EN 60529, EN 61000-6-2, EN 61000-6-3, EN 61326-1, EN 60664-1, EN 60947-1, EN 50581, EN ISO 13849-1, EN ISO 13849-2, EN ISO 62061, UL 508, CSA C22.2 n° 14-95, GB/T14048.5-2017

##### Output circuit

Output contacts:

2 NO safety contacts

Contact type:

forcibly guided

Material of the contacts:

silver alloy

Maximum switching voltage:

230/240 Vac; 300 Vdc

Max. current per contact:

6 A

Conventional free air thermal current I<sub>th</sub>:

6 A

Max. total current Σ I<sub>th</sub><sup>2</sup>:

36 A<sup>2</sup>

Minimum current:

10 mA

Contact resistance:

≤ 100 mΩ

External protection fuse:

4 A

The number and the load capacity of output contacts can be increased by using expansion modules or contactors. See pages 263-272.

#### Code structure

## CS AR-40V024

##### Start mode

**40** manual or automatic start

**41** monitored start

##### Supply voltage

**024** 24 Vac/dc

##### Connection type

**V** Screw terminals

**M** Connector with screw terminals

**X** Connector with spring terminals

#### Features approved by UL

Rated supply voltage (U<sub>n</sub>): 24 Vac/dc; 50...60 Hz

Power consumption AC: < 5 VA

Power consumption DC: < 4 W

Electrical ratings: 230/240 Vac

6 A general use

C300 pilot duty

##### Notes:

- Use 60 or 75°C copper (Cu) conductor and wire size No. 30-12 AWG, stranded or solid.

- The terminal tightening torque of 5-7 lb in.

- Only for 24 Vac/dc versions: supply from remote Class 2 source or limited voltage limited energy.



### Safety module CS AR-40 / CS AR-41

#### Pin assignment

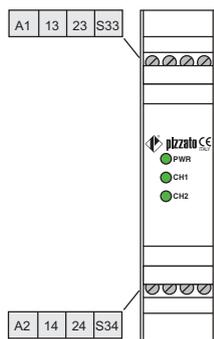

#### Internal block diagram

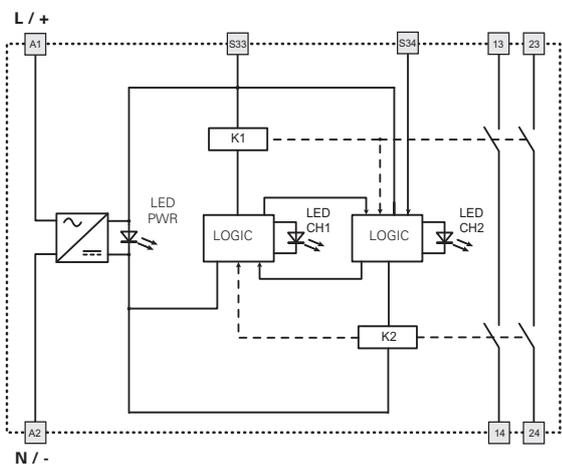

#### Input configuration

Emergency stop circuits
One channel input configuration with manual start

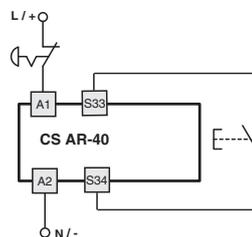

The diagram does not show the exact position of the terminals in the product

#### Automatic start

With regard to the indicated diagram, bridge the start button between S33 and S34 in order to activate the automatic start module.

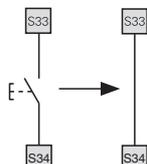

#### Monitored start

Use module CS AR-41 with the circuit diagrams for manual start.

#### Movable guard monitoring

The safety module can monitor emergency stop circuits and control circuits for movable guards. Replace the emergency stop contacts with the switch contacts.

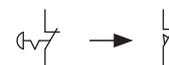

#### Function diagrams

1-channel configuration with automatic start (CS AR-40 only)

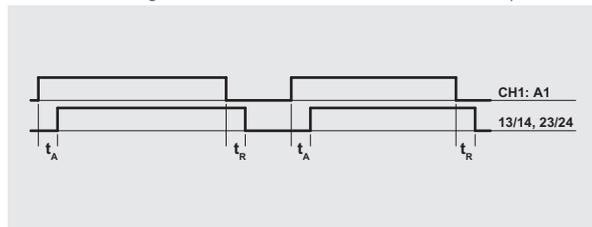

1-channel configuration with manual start (CS AR-40 only)

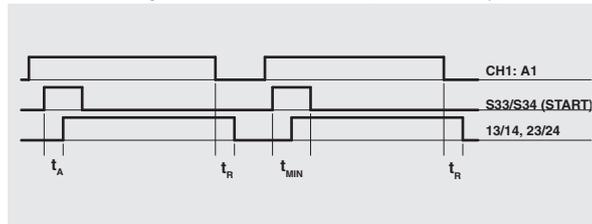

1-channel configuration with monitored start (CS AR-41 only)

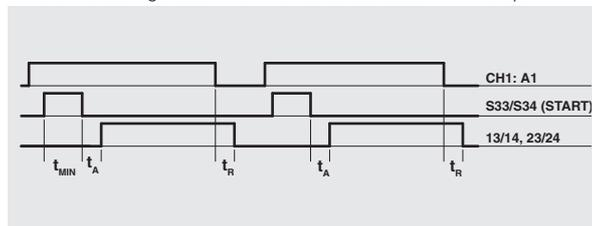

Legend:  
 $t_{MIN}$ : Min. duration of start impulse  
 $t_A$ : response time  
 $t_R$ : release time in absence of power supply

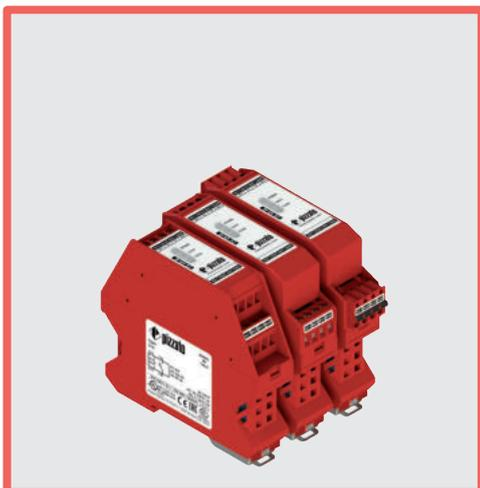

### Module for emergency stop, end position monitoring for movable guards, and magnetic safety sensors and devices

#### Main features

- For safety applications up to SIL CL 1/PL c
- Reduced housing width of 22.5 mm
- 1 NO safety contact
- Supply voltage: 24 Vac/dc

#### Utilization categories

Alternating current: AC15 (50...60 Hz)

U<sub>e</sub> (V) 230

I<sub>e</sub> (A) 3

Direct current: DC13 (6 oper. cycles/min.)

U<sub>e</sub> (V) 24

I<sub>e</sub> (A) 4

#### Quality marks:



UL approval: E131787

CCC approval: 2013010305640211

EAC approval: RU C-IT.YT03.B.00035/19

#### Compliance with the requirements of:

Machinery Directive 2006/42/EC,

EMC Directive 2014/30/EC,

RoHS Directive 2011/65/EU.

#### Technical data

##### Housing

Polyamide housing PA 66, self-extinguishing V0 acc. to UL 94

Protection degree acc. to EN 60529:

IP40 (housing), IP20 (terminal strip)

Dimensions:

see page 317, design D

##### General data

SIL level (SIL CL) up to:

SIL CL 1 acc. to EN 62061

Performance Level (PL) up to:

PL c acc. to EN ISO 13849-1

Safety category up to:

cat. 1 acc. to EN ISO 13849-1

Safety parameters:

see page 375

Ambient temperature:

-25°C...+55°C

Mechanical endurance:

>10 million operating cycles

Electrical endurance:

>100,000 operating cycles

Pollution degree:

external 3, internal 2

Rated impulse withstand voltage (U<sub>imp</sub>):

4 kV

Rated insulation voltage (U<sub>i</sub>):

250 V

Overvoltage category:

II

##### Supply

Rated supply voltage (U<sub>n</sub>):

24 Vac/dc; 50...60 Hz

Max. DC residual ripple in DC:

10%

Supply voltage tolerance:

±15% of U<sub>n</sub>

Power consumption AC:

< 5 VA

Power consumption DC:

< 2 W

##### Control circuit

Protection against short circuits:

PTC resistance, I<sub>h</sub>=0.5 A

PTC times:

Response time > 100 ms, release time > 3 s

Maximum resistance per input:

≤ 50 Ω

Current per input:

20 mA (typical)

Response time t<sub>A</sub>:

< 15 ms

Release time t<sub>R1</sub>:

< 20 ms

Release time in absence of power supply t<sub>R</sub>:

< 100 ms

Simultaneity time t<sub>C</sub>:

unlimited

##### In compliance with standards:

EN 60204-1, EN ISO 13855, EN 1037, EN ISO 12100, EN ISO 13850, EN 60529, EN 61000-6-2, EN 61000-6-3, EN 61326-1, EN 60664-1, EN 60947-1, EN 50581, EN ISO 13849-1, EN ISO 13849-2, EN 62061, UL 508, CSA C22.2 n° 14-95, GB/T14048.5-2017

##### Output circuit

Output contacts:

1 NO safety contact

Material of the contacts:

silver alloy

Maximum switching voltage:

230/240 Vac; 300 Vdc

Max. current per contact:

6 A

Conventional free air thermal current I<sub>th</sub>:

6 A

Minimum current:

10 mA

Contact resistance:

≤ 100 mΩ

External protection fuse:

4 A

The number and the load capacity of output contacts can be increased by using expansion modules or contactors. See pages 263-272.

#### Code structure

## CS AR-46V024

#### Connection type

<b>V</b>	Screw terminals
<b>M</b>	Connector with screw terminals
<b>X</b>	Connector with spring terminals

#### Supply voltage

**024** 24 Vac/dc

#### Features approved by UL

Rated supply voltage (U <sub>n</sub> ):	24 Vac/dc; 50...60 Hz
Power consumption AC:	< 5 VA
Power consumption DC:	< 4 W
Electrical ratings:	230/240 Vac 6 A general use C300 pilot duty

#### Notes:

- Use 60 or 75°C copper (Cu) conductor and wire size No. 30-12 AWG, stranded or solid.
- The terminal tightening torque of 5-7 lb.in.
- Only for 24 Vac/dc versions: supply from remote Class 2 source or limited voltage limited energy.



# Safety module CS AR-46

## Pin assignment

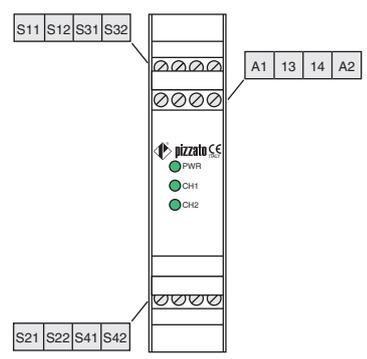

## Function diagrams

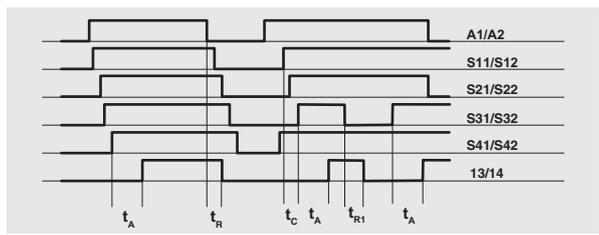

Legend:  
 $t_C$ : simultaneity time  
 $t_A$ : response time  
 $t_{R1}$ : release time  
 $t_A''$ : release time in absence of power supply

## Internal block diagram

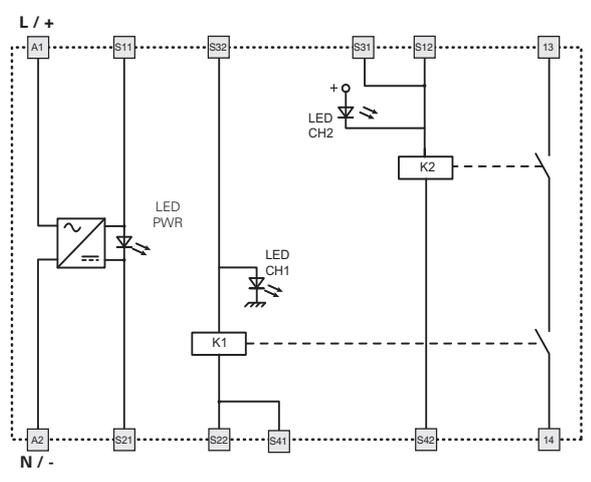

## Input configuration

Emergency stop circuits		
Input configuration with automatic start		
2 channels and 1 emergency button	2 channels and 2 emergency buttons	2 channels and 4 switches

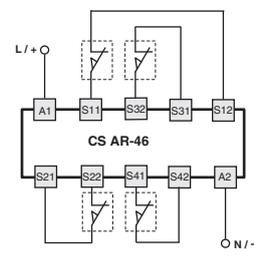
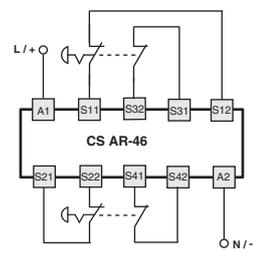
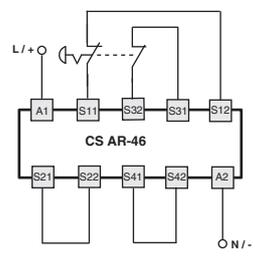

## Monitoring of movable guards and magnetic safety sensors

The safety module can monitor emergency stop circuits, control circuits for movable guards as well as magnetic safety sensors. Replace the emergency stop contacts with switch contacts or sensor contacts. The sensors can only be used in 2-channel configuration.

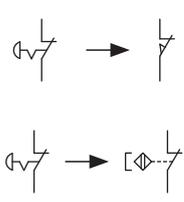

## 1 channel and 1 emergency button

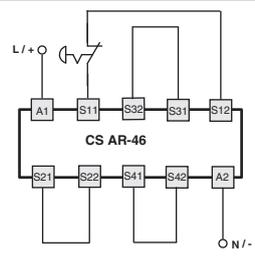



### Module for emergency stops, end position monitoring for movable guards and magnetic safety sensors

#### Main features

- For safety applications up to SIL 3/PL e
- Choice between automatic start, manual start or monitored start
- Connection of input channels of opposite potentials
- Reduced housing width of 22.5 mm
- Output contacts:  
2 NO safety contacts, 1 NO opto-decoupled auxiliary contact
- Supply voltage: 24 Vac/dc
- Insensitive to voltage dips

#### Utilization categories

Alternating current: AC15 (50...60 Hz)

U<sub>e</sub> (V) 230

I<sub>e</sub> (A) 3

Direct current: DC13 (6 oper. cycles/min.)

U<sub>e</sub> (V) 24

I<sub>e</sub> (A) 4

#### Quality marks:



EU-type examination certificate: IMQ n. 340

(EN 81-20:2014; EN 81-50:2014; EN 81-1:1998+A3:2009;

EN 81-2:1998+A3:2009)

EC type examination certificate: IMQ CP 432 DM

(Machinery Directive)

UL approval: E131787

CCC approval: 2013010305640211

EAC approval: RU C-IT.YT03.B.00035/19

#### Compliance with the requirements of:

Machinery Directive 2006/42/EC,

EMC Directive 2014/30/EC,

RoHS Directive 2011/65/EU,

Lifts Directive 2014/33/EU

### Technical data

#### Housing

Polyamide housing PA 66, self-extinguishing V0 acc. to UL 94

Protection degree acc. to EN 60529:

IP40 (housing), IP20 (terminal strip)

Dimensions:

see page 317, design A

#### General data

SIL level (SIL CL) up to:

SIL CL 3 acc. to EN 62061

Performance Level (PL) up to:

PL e acc. to EN ISO 13849-1

Safety category up to:

cat. 4 acc. to EN ISO 13849-1

Safety parameters:

see page 375

Ambient temperature:

-25°C...+55°C

Mechanical endurance:

>10 million operating cycles

Electrical endurance:

>100,000 operating cycles

Pollution degree:

external 3, internal 2

Rated impulse withstand voltage (U<sub>imp</sub>):

4 kV

Rated insulation voltage (U<sub>i</sub>):

250 V

Overvoltage category:

II

#### Supply

Rated supply voltage (U<sub>n</sub>):

24 Vac/dc; ±15%; 50...60 Hz

Max. DC residual ripple in DC:

10%

Power consumption AC:

< 5 VA

Power consumption DC:

< 2.5 W

#### Control circuit

Protection against short circuits:

PTC resistance, I<sub>h</sub>=0.5 A

PTC response time:

Response time > 100 ms, release time > 3 s

Maximum resistance per input:

≤ 50 Ω

Current per input:

< 40 mA

Min. duration of start impulse t<sub>MIN</sub>:

> 50 ms

Response time t<sub>A</sub>:

< 120 ms

Release time t<sub>R1</sub>:

< 15 ms

Release time in absence of power supply t<sub>R</sub>:

< 65 ms

Simultaneity time t<sub>c</sub>:

unlimited

Response time starting from application of the

supply:

< 300 ms

#### Auxiliary signalling circuit

Auxiliary output (Y43-Y44):

1 NO opto-decoupled

Rated operating voltage (U<sub>e</sub>):

24 Vdc

Rated operating current (I<sub>e</sub>):

25 mA

Rated impulse withstand voltage (U<sub>imp</sub>):

4 kV

Release time t<sub>R2</sub>:

< 1 ms

#### In compliance with standards:

EN 60204-1, EN ISO 13855, EN 1037, EN ISO 12100, EN ISO 13850, EN 60529,

EN 61000-6-2, EN 61000-6-3, EN 61326-1, EN 60664-1, EN 60947-1, EN 50581,

EN ISO 13849-1, EN ISO 13849-2, EN 62061, UL 508, CSA C22.2 n° 14-95,

GB/T 14048.5-2017

#### Output circuit

Output contacts:

2 NO safety contacts,

Contact type:

forcibly guided

Material of the contacts:

gold-plated silver alloy

Maximum switching voltage:

230/240 Vac; 300 Vdc

Max. current per contact:

6 A

Conventional free air thermal current I<sub>th</sub>:

6 A

Max. total current Σ I<sub>th</sub><sup>2</sup>:

36 A<sup>2</sup>

Minimum current:

10 mA

Contact resistance:

≤ 100 mΩ

External protection fuse:

4 A type F

The number and the load capacity of output contacts can be increased by using expansion modules or contactors. See pages 263-272.

### Code structure

## CS AR-91V024

#### Connection type

<b>V</b>	Screw terminals
<b>M</b>	Connector with screw terminals
<b>X</b>	Connector with spring terminals

#### Supply voltage

**024** 24 Vac/dc

### Features approved by UL

Rated supply voltage (U <sub>n</sub> ):	24 Vac/dc; 50...60 Hz
Power consumption AC:	< 5 VA
Power consumption DC:	< 4 W
Electrical ratings:	230/240 Vac 6 A general use C300 pilot duty

#### Notes:

- Use 60 or 75°C copper (Cu) conductor and wire size No. 30-12 AWG, stranded or solid.

- The terminal tightening torque of 5-7 lb in.

- Only for 24 Vac/dc versions: supply from remote Class 2 source or limited voltage limited energy.



### Safety module CS AR-91

#### Pin assignment

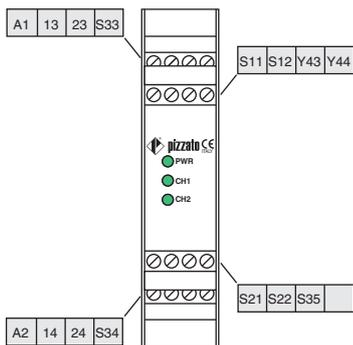

#### Voltage dips, short interruptions and voltage variations

The CS AR-91 safety module has a built-in voltage drop sensor which serves to protect and safeguard the internal state of the safety relays, in the event of dips or short voltage interruptions. This is to prevent unwanted switching states in relation to the state of the inputs from occurring. When voltage is restored, the device continues to operate with a switching state that is consistent with the input signals. The safety module retains its normal function during voltage dips and brief interruptions; for longer voltage interruptions, the safety outputs open and reset themselves automatically during an automatic start if voltage is restored or – in the case of a manual or monitored start – require that the system be reset by the operator.

#### Function diagrams

Configuration with automatic start

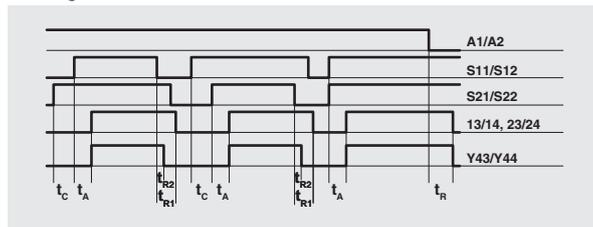

Configuration with monitored start

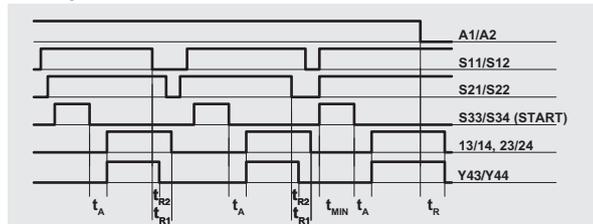

Configuration with manual start

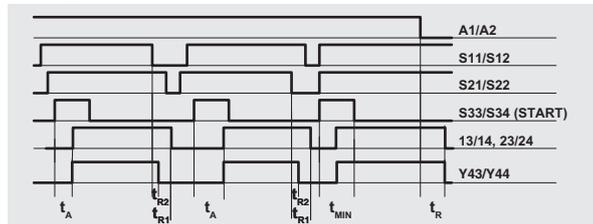

Legend:  
 $t_{MIN}$ : Min. duration of start impulse  
 $t_{R1}$ : release time  
 $t_{R2}$ : release time in absence of power supply  
 $t_C$ : simultaneity time  
 $t_A$ : response time

Notes:  
 The configurations with one channel are obtained taking into consideration the S11/ S12 input only. In this case it is necessary to consider time  $t_{R1}$  referred to input S11/S12, time  $t_R$  referred to the supply, time  $t_A$  referred to input S11/S12 and to the start, and time  $t_{MIN}$  referred to the start.

#### Internal block diagram

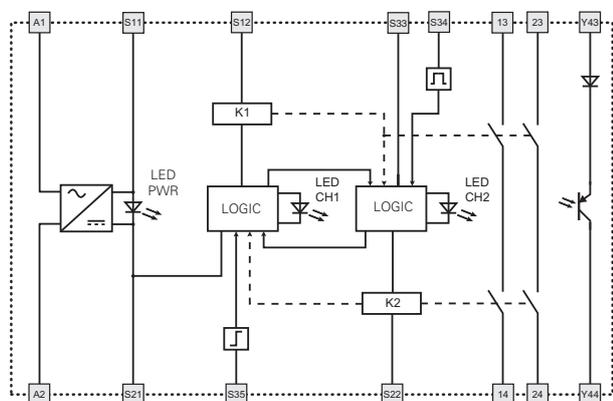

#### Input configuration

#### Input configuration with magnetic sensors 2 channels

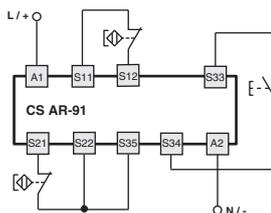

The diagram does not show the exact position of the terminals in the product

#### Automatic start

With regard to the indicated diagrams, bridge the start button between S33 and S34 in order to activate the automatic start module.

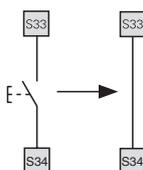

#### Monitored start

With regard to the indicated diagrams, remove the connection between S22 and S35 in order to activate the monitored start module.

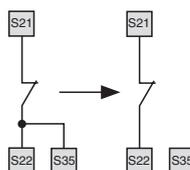

#### Monitoring of movable guards and magnetic safety sensors

The safety module can monitor emergency stop circuits, control circuits for movable guards as well as magnetic safety sensors. Replace the emergency stop contacts with switch contacts or sensor contacts. The sensors can only be used in 2-channel configuration.

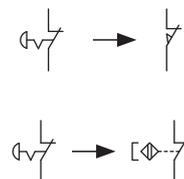



### Module for emergency stops, end position monitoring for movable guards, safety mats and safety bumpers with 4-wire technology

#### Main features

- For safety applications up to SIL CL 3/PL e
- Input with 2 channels
- Choice between automatic start, manual start or monitored start
- Connection of input channels of opposite potentials
- Can be connected to electromechanical contacts, safety mats or safety bumpers with 4-wire technology
- Output contacts:  
2 NO safety contacts,
- Supply voltage:  
24 Vac/dc

#### Utilization categories

Alternating current: AC15 (50...60 Hz)

U<sub>e</sub> (V) 230

I<sub>e</sub> (A) 3

Direct current: DC13 (6 oper. cycles/min.)

U<sub>e</sub> (V) 24

I<sub>e</sub> (A) 4

#### Quality marks:



EC type examination certificate: IMQ CP 432 DM

UL approval: E131787

CCC approval: 2013010305640211

EAC approval: RU C-IT.YT03.B.00035/19

#### Compliance with the requirements of:

Machinery Directive 2006/42/EC,

EMC Directive 2014/30/EC,

RoHS Directive 2011/65/EU.

### Technical data

#### Housing

Polyamide housing PA 66, self-extinguishing V0 acc. to UL 94

Protection degree acc. to EN 60529:

IP40 (housing), IP20 (terminal strip)

Dimensions:

see page 317, design A

#### General data

SIL level (SIL CL) up to:

SIL CL 3 acc. to EN 62061

Performance Level (PL) up to:

PL e acc. to EN ISO 13849-1

Safety category up to:

cat. 4 acc. to EN ISO 13849-1

Safety parameters:

see page 375

Ambient temperature:

-25°C...+55°C

Mechanical endurance:

>10 million operating cycles

Electrical endurance:

>100,000 operating cycles

Pollution degree:

external 3, internal 2

Rated impulse withstand voltage (U<sub>imp</sub>):

4 kV

Rated insulation voltage (U):

250 V

Overvoltage category:

II

#### Supply

Rated supply voltage (U<sub>n</sub>):

24 Vac/dc; 50...60 Hz

Max. DC residual ripple in DC:

10%

Supply voltage tolerance:

±15% of U<sub>n</sub>

Power consumption AC:

< 5 VA

Power consumption DC:

< 2.5 W

#### Control circuit

Protection against short circuits:

PTC resistance, I<sub>h</sub>=0.5 A

PTC times:

Response time > 100 ms, release time > 3 s

Maximum resistance per input:

≤ 200 Ω

Current per input:

10 mA (typical)

Min. duration of start impulse t<sub>MIN</sub>:

> 150 ms

Response time t<sub>A</sub>:

< 120 ms

Release time t<sub>R1</sub>:

< 15 ms

Release time in absence of power supply t<sub>R2</sub>:

< 100 ms

Simultaneity time t<sub>C</sub>:

unlimited

#### In compliance with standards:

EN 60204-1, EN ISO 13855, EN 1037, EN ISO 12100, EN ISO 13850, EN 60529, EN 61000-6-2, EN 61000-6-3, EN 61326-1, EN 60664-1, EN 60947-1, EN 50581, EN ISO 13849-1, EN ISO 13849-2, EN 62061, UL 508, CSA C22.2 n° 14-95, GB/T14048.5-2017

#### Output circuit

Output contacts:

2 NO safety contacts

Contact type:

forcibly guided

Material of the contacts:

gold-plated silver alloy

Maximum switching voltage:

230/240 Vac; 300 Vdc

Max. current per contact:

6 A

Conventional free air thermal current I<sub>th</sub>:

6 A

Max. total current Σ I<sub>th</sub><sup>2</sup>:

36 A<sup>2</sup>

Minimum current:

10 mA

Contact resistance:

≤ 100 mΩ

External protection fuse:

4 A

The number and the load capacity of output contacts can be increased by using expansion modules or contactors. See pages 263-272.

### Code structure

## CS AR-51V024

#### Connection type

**V** Screw terminals

**M** Connector with screw terminals

**X** Connector with spring terminals

#### Supply voltage

**024** 24 Vac/dc

### Features approved by UL

Rated supply voltage (U<sub>n</sub>): 24 Vac/dc; 50...60 Hz

Power consumption AC: < 5 VA

Power consumption DC: < 4 W

Electrical ratings: 230/240 Vac

6 A general use

C300 pilot duty

#### Notes:

- Use 60 or 75°C copper (Cu) conductor and wire size No. 30-12 AWG, stranded or solid.

- The terminal tightening torque of 5-7 lb in.

- Only for 24 Vac/dc versions: supply from remote Class 2 source or limited voltage limited energy.





### Safety module CS AR-51

#### Pin assignment

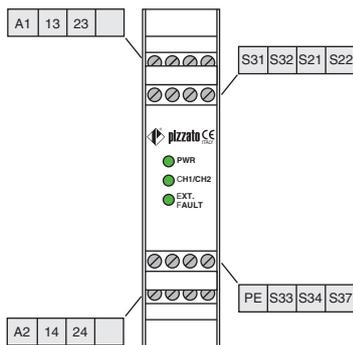

#### PE terminal connection

The PE terminal has to be connected to the equipotential circuit of machine protection if it is necessary. This connection is made for functional reason, to reduce effects of an insulation fault on the machine operation. In particular, ground faults in control circuits must not cause unwanted start-up or dangerous movements or prevent the machine from stopping.

#### Function of "EXT. FAULT" LED

When a pressure is exerted on the surface of a safety bumper or safety mat, a short-circuit occurs between the two conductive elements, which constitute the apparatus and can be connected to the input channels of the safety module.

The signal thereby generated causes the EXT.FAULT LED to illuminate and signal the short-circuit and the opening of the output contacts, resulting in the blocking of the control circuit and causing the machine to switch to the safety setting. The EXT. FAULT LED does not switch on if the wires or internal connections of the safety mat or safety bumper are interrupted.

#### Internal block diagram

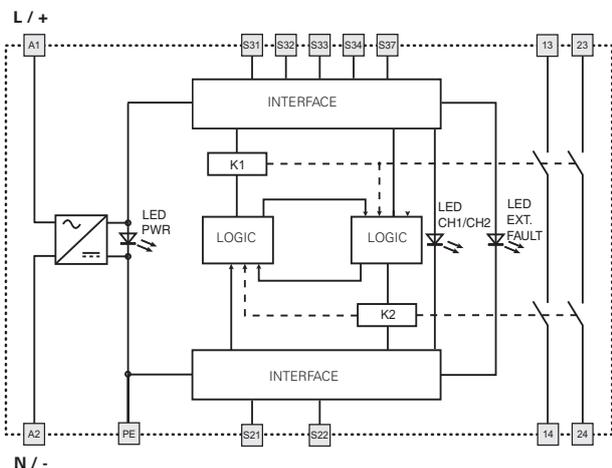

#### Input configuration

Safety mats and safety bumpers  
Input configuration with manual start  
2 channels

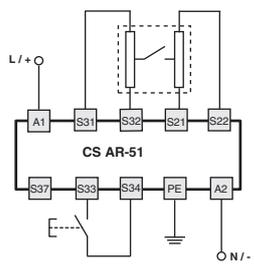

Emergency stop circuits  
Input configuration with manual start  
2 channels

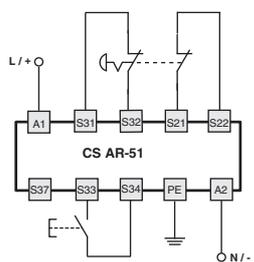

#### Function diagrams

Configuration with automatic start

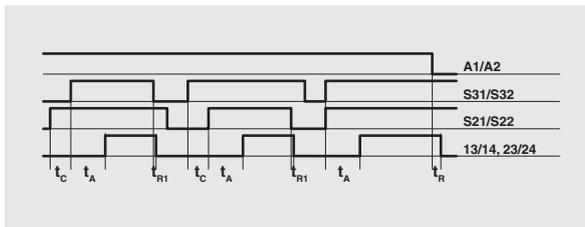

Configuration with monitored start

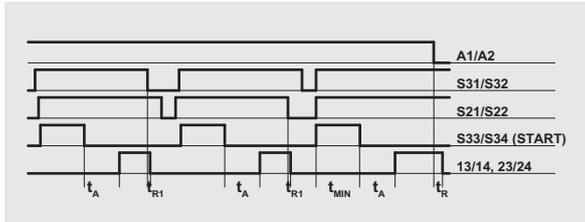

Configuration with manual start

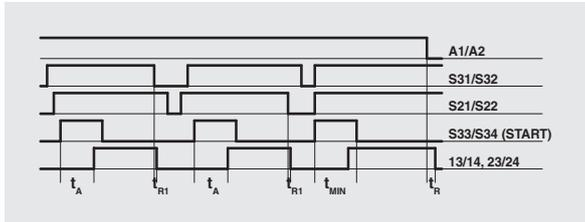

Legend:  
t<sub>MIN</sub>: Min. duration of start impulse  
t<sub>C</sub>: simultaneity time  
t<sub>A</sub>: response time  
t<sub>R1</sub>: release time  
t<sub>R</sub>: release time in absence of power supply

#### Automatic start

With regard to the indicated diagrams, bridge the start button between S33 and S34 in order to activate the automatic start module.

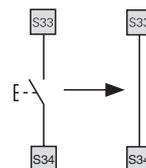

#### Monitored start

With regard to the indicated diagrams, establish the connection between S34 and S37 in order to activate the monitored start module.

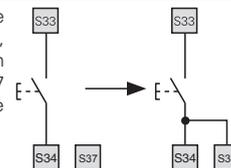

#### Movable guard monitoring

The safety module can monitor emergency stop circuits and control circuits for movable guards. Replace the emergency stop contacts with the switch contacts.

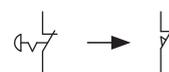

The diagram does not show the exact position of the terminals in the product



**Module for emergency stops, end position monitoring for movable guards with delayed contacts at the opening of the input channels, OSSD semiconductor outputs and magnetic safety sensors**

**Main features**

- For safety applications up to SIL CL 3/PL e
- Input with 1 or 2 channels
- Choice between automatic start, manual start or monitored start
- Connection of input channels of opposite potentials
- Can be connected to OSSD semiconductor outputs, to electromechanical contacts or to magnetic safety sensors
- Standard housing width of 45 mm
- 2 instantaneous NO safety contacts, 1 instantaneous NC auxiliary contact, 2 delayed NO safety contacts.
- Supply voltage: 24 Vac/dc, 120 Vac, 230 Vac

**Utilization categories**

Alternating current: AC15 (50...60 Hz)

U<sub>e</sub> (V) 230

I<sub>e</sub> (A) 3

Direct current: DC13 (6 oper. cycles/min.)

U<sub>e</sub> (V) 24

I<sub>e</sub> (A) 4

**Quality marks:**



EC type examination certificate: IMQ CP 432 DM

UL approval: E131787

CCC approval: 2013010305640211

EAC approval: RU C-IT.YT03.B.00035/19

**Compliance with the requirements of:**

Machinery Directive 2006/42/EC, EMC Directive 2014/30/EC, RoHS Directive 2011/65/EU.

**Technical data**

**Housing**

Polyamide housing PA 66, self-extinguishing V0 acc. to UL 94

Protection degree acc. to EN 60529:

IP40 (housing), IP20 (terminal strip)

Dimensions:

see page 317, design C

**General data**

SIL level (SIL CL) up to:

SIL CL 3 acc. to EN 62061

Performance Level (PL) up to:

PL e acc. to EN ISO 13849-1

Safety category up to:

category 4 (instantaneous contacts),

category 3 (delayed contacts)

acc. to EN ISO 13849-1

see page 375

Safety parameters:

Ambient temperature:

-25°C...+55°C

Mechanical endurance:

> 10 million operating cycles

Electrical endurance:

> 100,000 operating cycles

Pollution degree:

external 3, internal 2

Rated impulse withstand voltage (U<sub>imp</sub>):

4 kV

Rated insulation voltage (U<sub>i</sub>):

250 V

Overvoltage category:

II

**Supply**

Rated supply voltage (U<sub>n</sub>):

24 Vac/dc; 50...60 Hz

120 Vac; 50...60 Hz

230 Vac; 50...60 Hz

Max. DC residual ripple in DC:

10%

Supply voltage tolerance:

±15% of U<sub>n</sub>

Power consumption AC:

< 10 VA

Power consumption DC:

< 5 W

**Control circuit**

Protection against short circuits:

PTC resistance, I<sub>h</sub>=0.5 A

PTC times:

Response time > 100 ms, release time > 3 s

Maximum resistance per input:

≤ 50 Ω

Current per input:

30 mA (typical)

Min. duration of start impulse t<sub>MIN</sub>:

> 200 ms

Response time t<sub>A</sub>:

< 150 ms

Release time t<sub>R1</sub>:

< 25 ms

Release time in absence of power supply t<sub>R</sub>:

< 150 ms

Release time, delayed contacts t<sub>R2</sub>:

see "Code structure"

Simultaneity time t<sub>C</sub>:

unlimited

**In compliance with standards:**

EN 60204-1, EN ISO 13855, EN 1037, EN ISO 12100, EN ISO 13850, EN 60529, EN 61000-6-2, EN 61000-6-3, EN 61326-1, EN 60664-1, EN 60947-1, EN 50581, EN ISO 13849-1, EN ISO 13849-2, EN 62061, UL 508, CSA C22.2 n° 14-95, GB/T 14048.5-2017

**Output circuit**

Output contacts:

2 instantaneous NO safety contacts,

1 instantaneous NC auxiliary contact,

2 delayed NO safety contacts.

Contact type:

forcibly guided

Material of the contacts:

gold-plated silver alloy

Maximum switching voltage:

230/240 Vac; 300 Vdc

Max. current per contact:

6 A

Conventional free air thermal current I<sub>th</sub>:

6 A

Max. total current Σ I<sub>th</sub><sup>2</sup>:

72 (instant. contacts), 36 (del. contacts) A<sup>2</sup>

Minimum current:

10 mA

Contact resistance:

≤ 100 mΩ

External protection fuse:

4 A

The number and the load capacity of output contacts can be increased by using expansion modules or contactors. See pages 263-272.

**Code structure**

article options  
**CS AT-00V024-TF1**

Release time, delayed contacts (t<sub>R2</sub>)

<b>0</b>	Fixed time (see TF)
<b>1</b>	0.3 ... 3 s, 0.3 s steps
<b>2</b>	1 ... 10 s, 1 s steps
<b>3</b>	3 ... 30 s, 3 s steps
<b>4</b>	30 ... 300 s, 30 s steps

Release time, delayed contacts (t<sub>R2</sub>)

<b>TF0.5</b>	0.5 s fixed time
<b>TF1</b>	1 s fixed time
<b>TF3</b>	3 s fixed time
...	.....

Supply voltage

<b>024</b>	24 Vac/dc
<b>120</b>	120 Vac
<b>230</b>	230 Vac

Connection type

<b>V</b>	Screw terminals
<b>M</b>	Connector with screw terminals
<b>X</b>	Connector with spring terminals

**Features approved by UL**

Rated supply voltage (U <sub>n</sub> ):	24 Vac/dc; 50...60 Hz 120 Vac; 50...60 Hz 230 Vac; 50...60 Hz
Power consumption AC:	< 10 VA
Power consumption DC:	< 4 W
Electrical ratings:	230/240 Vac 6 A general use C300 pilot duty

Notes:

- Use 60 or 75°C copper (Cu) conductor and wire size No. 30-12 AWG, stranded or solid.
- The terminal tightening torque of 5-7 lb in.
- Only for 24 Vac/dc versions: supply from remote Class 2 source or limited voltage limited energy.
- Surrounding air of 55°C.



### Safety module CS AT-0

#### Pin assignment

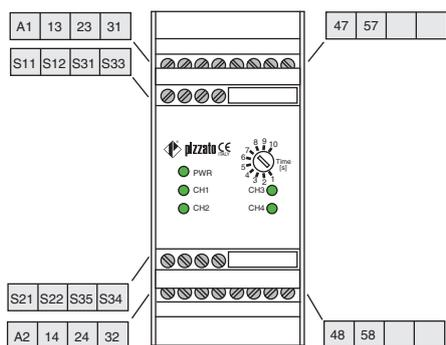

#### Internal block diagram

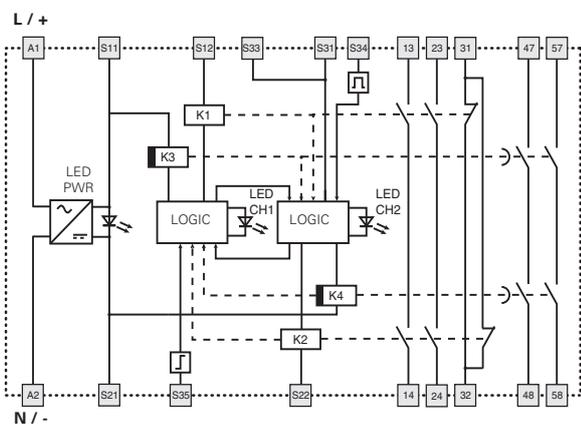

#### Input configuration

OSSD semiconductor outputs (e.g. ST, NS, NG series or light barriers)  
 Input configuration with manual start

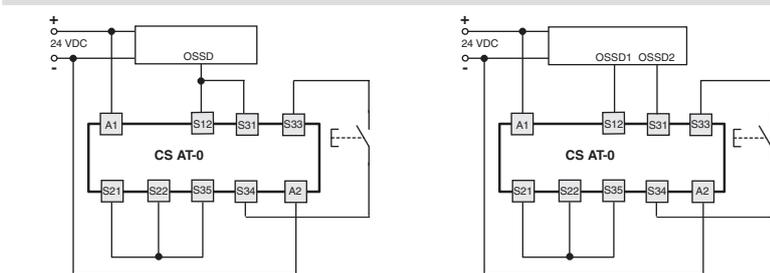

Emergency stop circuits  
 Input configuration with manual start

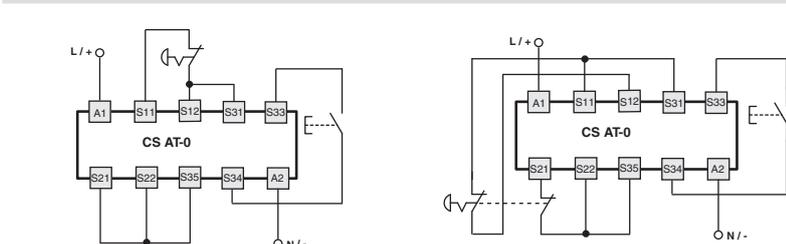

#### Function diagrams

Configuration with automatic start

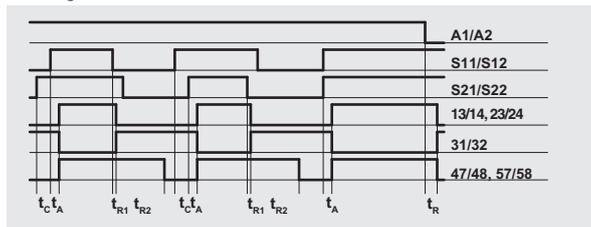

Configuration with monitored start

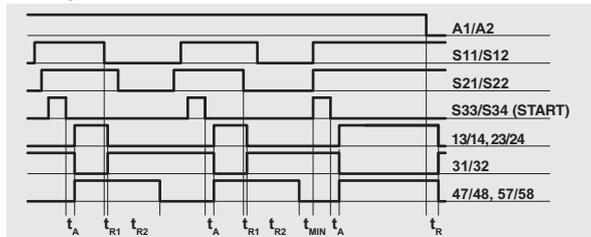

Configuration with manual start

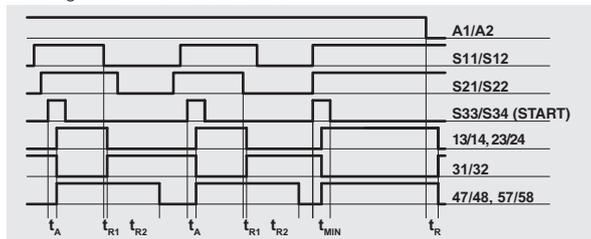

- Legend:
- $t_{MIN}$ : Min. duration of start impulse
  - $t_c$ : simultaneity time
  - $t_r$ : response time
  - $t_{r1}$ : release time
  - $t_{r2}$ : release time in absence of power supply
  - $t_{r2}$ : release time, delayed contacts adjustable (see "Code structure")

Notes:  
 The configurations with one channel are obtained taking into consideration the S11/S12 input only. In this case it is necessary to consider time  $t_{r1}$  and  $t_{r2}$  referred to input S11/S12, time  $t_r$  referred to the supply, time  $t_A$  referred to input S11/S12 and to the start, and time  $t_{MIN}$  referred to the start.

#### Automatic start

With regard to the indicated diagrams, bridge the start button between S33 and S34 in order to activate the automatic start module.

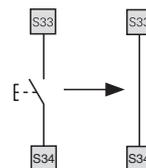

#### Monitored start

With regard to the indicated diagrams, remove the connection between S22 and S35 in order to activate the monitored start module.

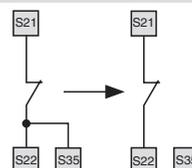

#### Monitoring of movable guards and magnetic safety sensors

The safety module can monitor emergency stop circuits, control circuits for movable guards as well as magnetic safety sensors. Replace the emergency stop contacts with switch contacts or sensor contacts. The sensors can only be used in 2-channel configuration.

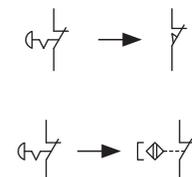

The diagram does not show the exact position of the terminals in the product



**Module for emergency stops, end position monitoring for movable guards with delayed contacts at the opening of the input channels, OSSD semiconductor outputs and magnetic safety sensors**

#### Main features

- For safety applications up to SIL CL 3/PL e
- Input with 1 or 2 channels
- Choice between automatic start, manual start or monitored start
- Connection of input channels of opposite potentials
- Can be connected to OSSD semiconductor outputs, to electromechanical contacts or to magnetic safety sensors
- Standard housing width of 45 mm
- 3 instantaneous NO safety contacts, 2 delayed NO safety contacts.
- Supply voltage: 24 Vac/dc, 120 Vac, 230 Vac

#### Utilization categories

Alternating current: AC15 (50...60 Hz)

U<sub>e</sub> (V) 230

I<sub>e</sub> (A) 3

Direct current: DC13 (6 oper. cycles/min.)

U<sub>e</sub> (V) 24

I<sub>e</sub> (A) 4

#### Quality marks:



EC type examination certificate: IMQ CP 432 DM

UL approval: E131787

CCC approval: 2013010305640211

EAC approval: RU C-IT.YT03.B.00035/19

#### Compliance with the requirements of:

Machinery Directive 2006/42/EC, EMC Directive 2014/30/EC, RoHS Directive 2011/65/EU.

#### Technical data

##### Housing

Polyamide housing PA 66, self-extinguishing V0 acc. to UL 94

Protection degree acc. to EN 60529:

IP40 (housing), IP20 (terminal strip)

Dimensions:

see page 317, design C

##### General data

SIL level (SIL CL) up to:

SIL CL 3 acc. to EN 62061

Performance Level (PL) up to:

PL e acc. to EN ISO 13849-1

Safety category up to:

category 4 (instantaneous contacts), category 3 (delayed contacts) acc. to EN ISO 13849-1

Safety parameters:

see page 375

Ambient temperature:

-25°C...+55°C

Mechanical endurance:

>10 million operating cycles

Electrical endurance:

>100,000 operating cycles

Pollution degree:

external 3, internal 2

Rated impulse withstand voltage (U<sub>imp</sub>):

4 kV

Rated insulation voltage (U):

250 V

Overtoltage category:

II

##### Supply

Rated supply voltage (U<sub>n</sub>):

24 Vac/dc; 50...60 Hz

120 Vac; 50...60 Hz

230 Vac; 50...60 Hz

Max. DC residual ripple in DC:

10%

Supply voltage tolerance:

±15% of U<sub>n</sub>

Power consumption AC:

< 10 VA

Power consumption DC:

< 5 W

##### Control circuit

Protection against short circuits:

PTC resistance, I<sub>h</sub>=0.5 A

PTC times:

Response time > 100 ms, release time > 3 s

Maximum resistance per input:

≤ 50 Ω

Current per input:

30 mA (typical)

Min. duration of start impulse t<sub>MIN</sub>:

> 200 ms

Response time t<sub>A</sub>:

< 150 ms

Release time t<sub>R1</sub>:

< 25 ms

Release time in absence of power supply t<sub>R</sub>:

< 150 ms

Release time, delayed contacts t<sub>R2</sub>:

see "Code structure"

Simultaneity time t<sub>C</sub>:

unlimited

##### In compliance with standards:

EN 60204-1, EN ISO 13855, EN 1037, EN ISO 12100, EN ISO 13850, EN 60529, EN 61000-6-2, EN 61000-6-3, EN 61326-1, EN 60664-1, EN 60947-1, EN 50581, EN ISO 13849-1, EN ISO 13849-2, EN 62061, UL 508, CSA C22.2 n° 14-95, GB/T14048.5-2017

##### Output circuit

Output contacts:

3 instantaneous NO safety contacts, 2 delayed NO safety contacts.

Contact type:

forcibly guided

Material of the contacts:

gold-plated silver alloy

Maximum switching voltage:

230/240 Vac; 300 Vdc

Max. current per contact:

6 A

Conventional free air thermal current I<sub>th</sub>:

6 A

Max. total current Σ I<sub>th</sub><sup>2</sup>:

72 (instant. contacts), 36 (del. contacts) A<sup>2</sup>

Minimum current:

10 mA

Contact resistance:

≤ 100 mΩ

External protection fuse:

4 A

The number and the load capacity of output contacts can be increased by using expansion modules or contactors. See pages 263-272.

#### Code structure

article options  
**CS AT-10V024-TF1**

Release time, delayed contacts (t<sub>R2</sub>)

- |   |                          |
|---|--------------------------|
| 0 | Fixed time (see TF)      |
| 1 | 0.3 ... 3 s, 0.3 s steps |
| 2 | 1 ... 10 s, 1 s steps    |
| 3 | 3 ... 30 s, 3 s steps    |
| 4 | 30 ... 300 s, 30 s steps |

Release time, delayed contacts (t<sub>R2</sub>)

- |       |                  |
|-------|------------------|
| TF0.5 | 0.5 s fixed time |
| TF1   | 1 s fixed time   |
| TF3   | 3 s fixed time   |
| ...   | .....            |

Connection type

- |   |                                 |
|---|---------------------------------|
| V | Screw terminals                 |
| M | Connector with screw terminals  |
| X | Connector with spring terminals |

Supply voltage

- |     |           |
|-----|-----------|
| 024 | 24 Vac/dc |
| 120 | 120 Vac   |
| 230 | 230 Vac   |

#### Features approved by UL

- |   |   |
|---|---|
| Rated supply voltage (U <sub>n</sub> ): | 24 Vac/dc; 50...60 Hz<br>120 Vac; 50...60 Hz<br>230 Vac; 50...60 Hz |
| Power consumption AC:                   | < 10 VA   |
| Power consumption DC:                   | < 4 W   |
| Electrical ratings:                     | 230/240 Vac<br>6 A general use<br>C300 pilot duty                   |

##### Notes:

- Use 60 or 75°C copper (Cu) conductor and wire size No. 30-12 AWG, stranded or solid.
- The terminal tightening torque of 5-7 lb in.
- Only for 24 Vac/dc versions: supply from remote Class 2 source or limited voltage limited energy.
- Surrounding air of 55°C.



### Safety module CS AT-1

#### Pin assignment

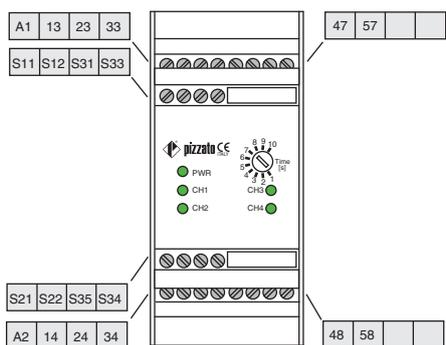

#### Internal block diagram

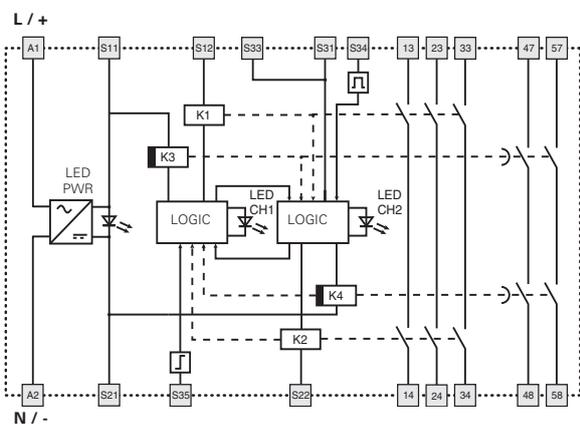

#### Input configuration

##### OSSD semiconductor outputs (e.g. ST, NS, NG series or light barriers)

##### Input configuration with manual start

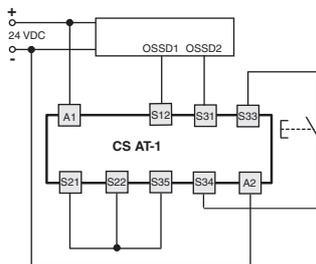
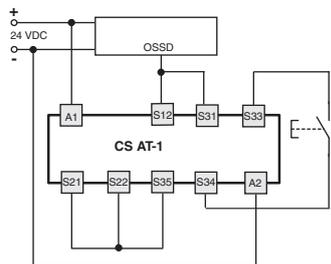

##### Emergency stop circuits

##### Input configuration with manual start

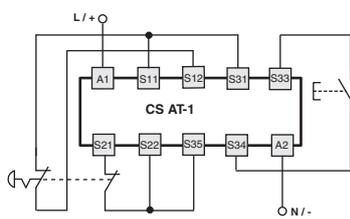
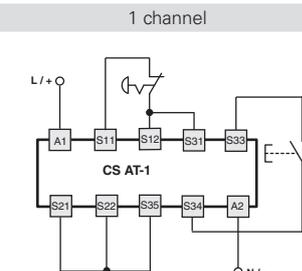

#### Function diagrams

##### Configuration with automatic start

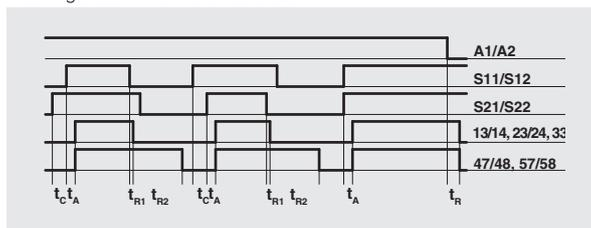

##### Configuration with monitored start

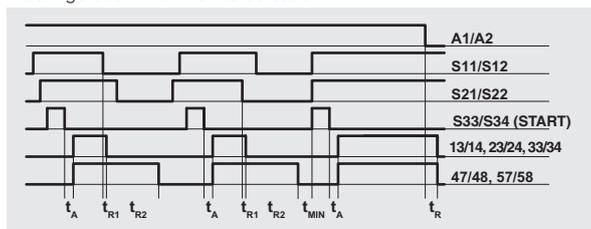

##### Configuration with manual start

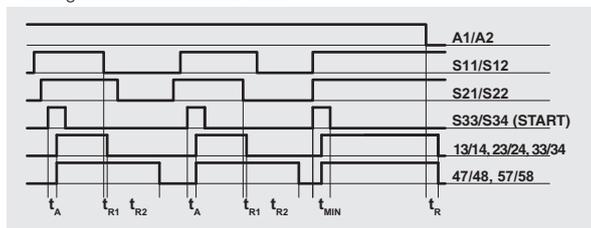

#### Legend:

- $t_{MIN}$ : Min. duration of start impulse
- $t_C$ : simultaneity time
- $t_A$ : response time
- $t_{R1}$ : release time
- $t_{R2}$ : release time in absence of power supply
- $t_{R1}$ : release time, delayed contacts adjustable (see "Code structure")

#### Notes:

The configurations with one channel are obtained taking into consideration the S11/S12 input only. In this case it is necessary to consider time  $t_{R1}$  and  $t_{R2}$  referred to input S11/S12, time  $t_A$  referred to the supply, time  $t_C$  referred to input S11/S12 and to the start, and time  $t_{MIN}$  referred to the start.

#### Automatic start

With regard to the indicated diagrams, bridge the start button between S33 and S34 in order to activate the automatic start module.

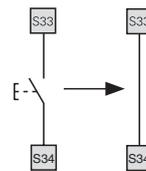

#### Monitored start

With regard to the indicated diagrams, remove the connection between S22 and S35 in order to activate the monitored start module.

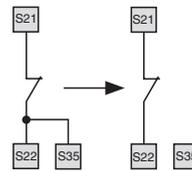

#### Monitoring of movable guards and magnetic safety sensors

The safety module can monitor emergency stop circuits, control circuits for movable guards as well as magnetic safety sensors. Replace the emergency stop contacts with switch contacts or sensor contacts.

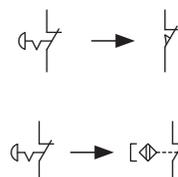

The sensors can only be used in 2-channel configuration.

The diagram does not show the exact position of the terminals in the product



### Module for emergency stop and end position monitoring for movable guards with delayed contacts at the opening of the input channels and magnetic safety sensors

#### Main features

- For safety applications up to SIL CL 3/PL e
- Input with 1 or 2 channels
- Choice between automatic start, manual start or monitored start
- Can be connected to electromechanical contacts or to magnetic safety sensors
- 45 mm housing
- 2 instantaneous NO safety contacts, 1 delayed NO safety contact.
- Supply voltage: 24 Vac/dc

#### Utilization categories

Alternating current: AC15 (50...60 Hz)

U<sub>e</sub> (V) 230

I<sub>e</sub> (A) 3

Direct current: DC13 (6 oper. cycles/min.)

U<sub>e</sub> (V) 24

I<sub>e</sub> (A) 4

#### Quality marks:



EC type examination certificate: IMQ CP 432 DM

UL approval: E131787

CCC approval: 2013010305640211

EAC approval: RU C-IT.YT03.B.00035/19

#### Compliance with the requirements of:

Machinery Directive 2006/42/EC, EMC Directive

2014/30/EC, RoHS Directive 2011/65/EU.

## Technical data

### Housing

Polyamide housing PA 66, self-extinguishing V0 acc. to UL 94

Protection degree acc. to EN 60529:

IP40 (housing), IP20 (terminal strip)

Dimensions:

see page 317, design C

### General data

SIL level (SIL CL) up to:

SIL CL 3 acc. to EN 62061

Performance Level (PL) up to:

PL e acc. to EN ISO 13849-1

Safety category up to:

category 4 (instantaneous contacts)

category 3 (delayed contacts)

acc. to EN ISO 13849-1

see page 375

Safety parameters:

Ambient temperature:

-25°C...+55°C

Mechanical endurance:

> 10 million operating cycles

Electrical endurance:

> 100,000 operating cycles

Pollution degree:

external 3, internal 2

Rated impulse withstand voltage (U<sub>imp</sub>):

4 kV

Rated insulation voltage (U<sub>i</sub>):

250 V

Overvoltage category:

II

### Supply

Rated supply voltage (U<sub>n</sub>):

24 Vac/dc; 50...60 Hz

Max. DC residual ripple in DC:

10%

Supply voltage tolerance:

±15% of U<sub>n</sub>

Power consumption AC:

< 10 VA

Power consumption DC:

< 5 W

### Control circuit

Protection against short circuits:

PTC resistance, I<sub>h</sub>=0.5 A

PTC times:

Response time > 100 ms, release time > 3 s

Maximum resistance per input:

≤ 50 Ω

Current per input:

30 mA (typical)

Min. duration of start impulse t<sub>MIN</sub>:

> 100 ms

Response time t<sub>A</sub>:

< 120 ms

Release time t<sub>R1</sub>:

< 15 ms

Release time in absence of power supply t<sub>R</sub>:

< 150 ms

Release time, delayed contacts t<sub>R2</sub>:

see "Code structure"

Simultaneity time t<sub>c</sub>:

unlimited

### In compliance with standards:

EN 60204-1, EN ISO 13855, EN 1037, EN ISO 12100, EN ISO 13850, EN 60529, EN 61000-6-2, EN 61000-6-3, EN 61326-1, EN 60664-1, EN 60947-1, EN 50581, EN ISO 13849-1, EN ISO 13849-2, EN 62061, UL 508, CSA C22.2 n° 14-95, GB/T14048.5-2017

### Output circuit

Output contacts:

2 instantaneous NO safety contacts,

1 delayed NO safety contact.

Contact type:

forcibly guided

Material of the contacts:

gold-plated silver alloy

Maximum switching voltage:

230/240 Vac; 300 Vdc

Max. current per contact:

6 A

Conventional free air thermal current I<sub>th</sub>:

6 A

Max. total current Σ I<sub>th</sub><sup>2</sup>:

36 A<sup>2</sup>

Minimum current:

10 mA

Contact resistance:

≤ 100 mΩ

External protection fuse:

4 A

The number and the load capacity of output contacts can be increased by using expansion modules or contactors. See pages 263-272.

## Code structure

article options  
**CS AT-30V024-TF1**

#### Release time, delayed contacts (t<sub>R2</sub>)

- |   |                          |
|---|--------------------------|
| 0 | Fixed time (see TF)      |
| 1 | 0.3 ... 3 s, 0.3 s steps |
| 2 | 1 ... 10 s, 1 s steps    |
| 3 | 3 ... 30 s, 3 s steps    |
| 4 | 30 ... 300 s, 30 s steps |

#### Release time, delayed contacts (t<sub>R2</sub>)

- |       |                  |
|-------|------------------|
| TF0.5 | 0.5 s fixed time |
| TF1   | 1 s fixed time   |
| TF3   | 3 s fixed time   |
| ...   | .....            |

#### Supply voltage

- |     |           |
|-----|-----------|
| 024 | 24 Vac/dc |
|-----|-----------|

#### Connection type

- |   |                                 |
|---|---------------------------------|
| V | Screw terminals                 |
| M | Connector with screw terminals  |
| X | Connector with spring terminals |

## Features approved by UL

Rated supply voltage (U <sub>n</sub> ):	24 Vac/dc; 50...60 Hz
Power consumption AC:	< 10 VA
Power consumption DC:	< 4 W
Electrical ratings:	230/240 Vac 6 A general use C300 pilot duty

#### Notes:

- Use 60 or 75°C copper (Cu) conductor and wire size No. 30-12 AWG, stranded or solid.
- The terminal tightening torque of 5-7 lb in.
- Only for 24 Vac/dc versions: supply from remote Class 2 source or limited voltage limited energy.
- Surrounding air of 55°C.



### Safety module CS AT-3

#### Pin assignment

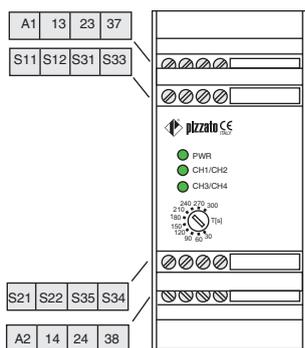

#### Internal block diagram

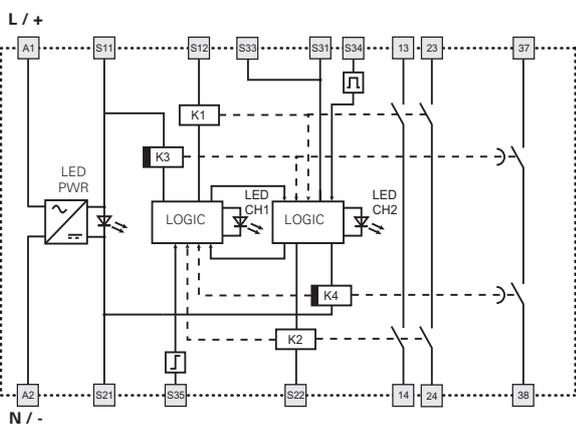

#### Function diagrams

Configuration with automatic start

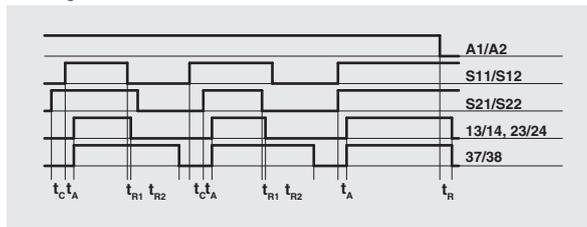

Configuration with monitored start

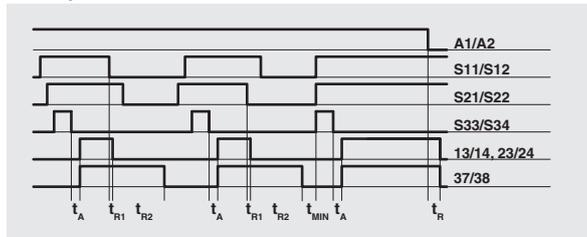

Configuration with manual start

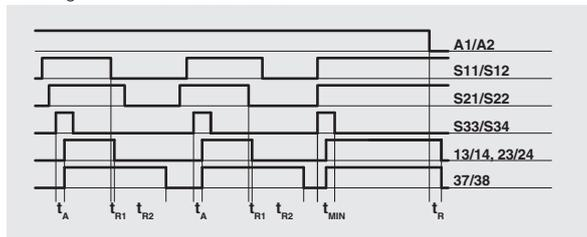

- Legend:
- $t_{MIN}$ : Min. duration of start impulse
  - $t_c$ : simultaneity time
  - $t_A$ : response time
  - $t_{R1}$ : release time
  - $t_{R2}$ : release time in absence of power supply
  - $t_{R2}$ : release time, delayed contacts adjustable (see "Code structure")

Notes:  
The configurations with one channel are obtained taking into consideration the S11/S12 input only. In this case it is necessary to consider times  $t_{R1}$  and  $t_{R2}$  referred to input S11/S12, time  $t_A$  referred to the supply, time  $t_A$  referred to input S11/S12 and to the start, and time  $t_{MIN}$  referred to the start.

#### Input configuration

Emergency stop circuits	
Input configuration with manual start	
1 channel	2 channels

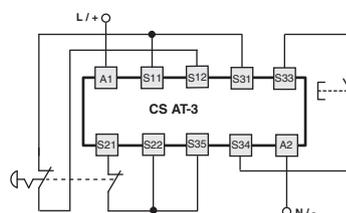
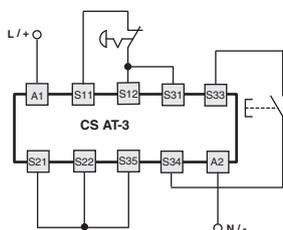

The diagram does not show the exact position of the terminals in the product

#### Automatic start

With regard to the indicated diagrams, bridge the start button between S33 and S34 in order to activate the automatic start module.

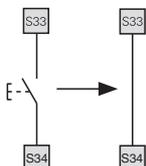

#### Monitored start

With regard to the indicated diagrams, remove the connection between S22 and S35 in order to activate the monitored start module.

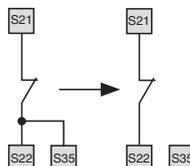

#### Monitoring of movable guards and magnetic safety sensors

The safety module can monitor emergency stop circuits, control circuits for movable guards as well as magnetic safety sensors. Replace the emergency stop contacts with switch contacts or sensor contacts. The sensors can only be used in 2-channel configuration.

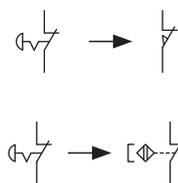

Application examples See page 273



### Safety timer module with delayed contacts at energizing

#### Main features

- For safety applications up to SIL CL 3/PL e
- Timing circuits by means of safety system with self-monitoring and redundancy
- Release command for interlocked safety devices
- 45 mm housing
- Output contacts:
  - 1 NO safety contact,
  - 2 NC auxiliary contacts
- Supply voltage:
  - 24 Vac/dc, 120 Vac, 230 Vac

#### Utilization categories

Alternating current: AC15 (50...60 Hz)

U<sub>e</sub> (V) 230

I<sub>e</sub> (A) 3

Direct current: DC13 (6 oper. cycles/min.)

U<sub>e</sub> (V) 24

I<sub>e</sub> (A) 4

#### Quality marks:



EC type examination certificate: IMQ CP 432 DM

UL approval: E131787

CCC approval: 2013010305640211

EAC approval: RU C-IT.YT03.B.00035/19

#### Compliance with the requirements of:

Machinery Directive 2006/42/EC, EMC Directive 2014/30/EC, RoHS Directive 2011/65/EU.

### Technical data

#### Housing

Polyamide housing PA 66, self-extinguishing V0 acc. to UL 94

Protection degree acc. to EN 60529:

IP40 (housing), IP20 (terminal strip)

Dimensions:

see page 317, design C

#### General data

SIL level (SIL CL) up to:

SIL CL 3 acc. to EN 62061

Performance Level (PL) up to:

PL e acc. to EN ISO 13849-1

Safety category up to:

cat. 4 acc. to EN ISO 13849-1 (depending on circuit structure)

Safety parameters:

see page 375

Ambient temperature:

-25°C...+55°C

Mechanical endurance:

>10 million operating cycles

Electrical endurance:

>100,000 operating cycles

Pollution degree:

external 3, internal 2

Rated impulse withstand voltage (U<sub>imp</sub>):

4 kV

Rated insulation voltage (U<sub>i</sub>):

250 V

Oversvoltage category:

II

#### Supply

Rated supply voltage (U<sub>n</sub>):

24 Vac/dc; 50...60 Hz

120 Vac; 50...60 Hz

230 Vac; 50...60 Hz

Max. DC residual ripple in DC:

10%

Supply voltage tolerance:

±15% of U<sub>n</sub>

Power consumption AC:

< 5 VA

Power consumption DC:

< 2 W

#### Control circuit

Protection against short circuits:

PTC resistance, I<sub>h</sub>=0.5 A

PTC times:

response time > 100 ms, release time > 3 s

Response time t<sub>A</sub>:

see "Code structure"

Release time in absence of

power supply t<sub>R</sub>:

< 60 ms

#### In compliance with standards:

EN 60204-1, EN ISO 13855, EN 1037, EN ISO 12100, EN ISO 13850, EN 60529, EN 61000-6-2, EN 61000-6-3, EN 61326-1, EN 60664-1, EN 60947-1, EN 50581, EN ISO 13849-1, EN ISO 13849-2, EN 62061, UL 508, CSA C22.2 n° 14-95, GB/T14048.5-2017

#### Output circuit

Output contacts:

1 NO safety contact,  
2 NC auxiliary contacts

Contact type:

forcibly guided

Material of the contacts:

silver alloy

Maximum switching voltage:

230/240 Vac; 300 Vdc

Max. current per contact:

6 A

Conventional free air thermal current I<sub>th</sub>:

6 A

Max. total current Σ I<sub>th</sub><sup>2</sup>:

36 A<sup>2</sup>

Minimum current:

10 mA

Contact resistance:

≤ 100 mΩ

External protection fuse:

4 A

The number and the load capacity of output contacts can be increased by using expansion modules or contactors. See pages 263-272.

### Code structure

article options  
**CS FS-11V024-TF1**

#### Response time (t<sub>A</sub>)

<b>0</b>	Fixed time (see Tfx)
<b>1</b>	0.3 ... 3 s, 0.3 s steps
<b>2</b>	1 ... 10 s, 1 s steps
<b>3</b>	3 ... 30 s, 3 s steps
<b>4</b>	30 ... 300 s, 30 s steps

#### Response time (t<sub>A</sub>)

<b>TF0.5</b>	0.5 s fixed time
<b>TF1</b>	1 s fixed time
<b>TF3</b>	3 s fixed time
<b>TF10</b>	10 s fixed time

#### Supply voltage

<b>024</b>	24 Vac/dc
<b>120</b>	120 Vac
<b>230</b>	230 Vac

#### Connection type

<b>V</b>	Screw terminals
<b>M</b>	Connector with screw terminals
<b>X</b>	Connector with spring terminals

### Features approved by UL

Rated supply voltage (U <sub>n</sub> ):	24 Vac/dc; 50...60 Hz 120 Vac; 50...60 Hz 230 Vac; 50...60 Hz
Power consumption AC:	< 5 VA
Power consumption DC:	< 2 W
Electrical ratings:	230/240 Vac 6 A general use C300 pilot duty

#### Notes:

- Use 60 or 75°C copper (Cu) conductor and wire size No. 30-12 AWG, stranded or solid.

- The terminal tightening torque of 5-7 lb in.

- Only for 24 Vac/dc versions: supply from remote Class 2 source or limited voltage limited energy.





### Safety module CS FS-1

#### Pin assignment

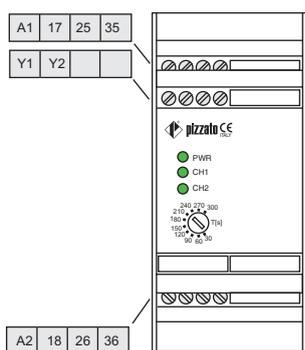

#### Function diagram

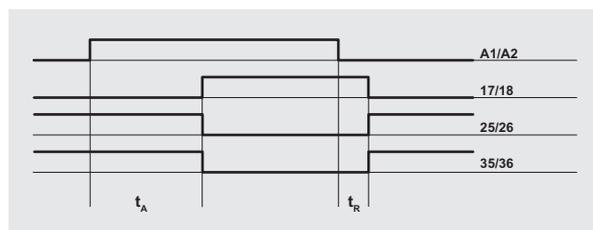

Legend:  
 $t_A$ : adjustable response time (see "Code structure")  
 $t_R$ : release time in absence of power supply

#### Internal block diagram

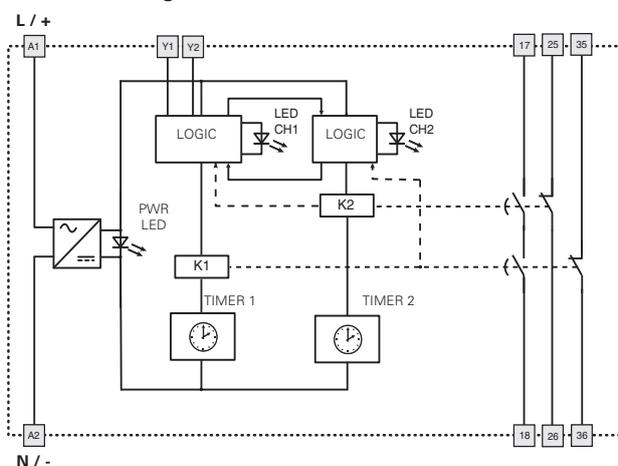

Y1-Y2: optional feedback inputs from any external contactors which are directly controlled by the module.

#### Circuit structure

### Monitoring of a door-lock system with manual release

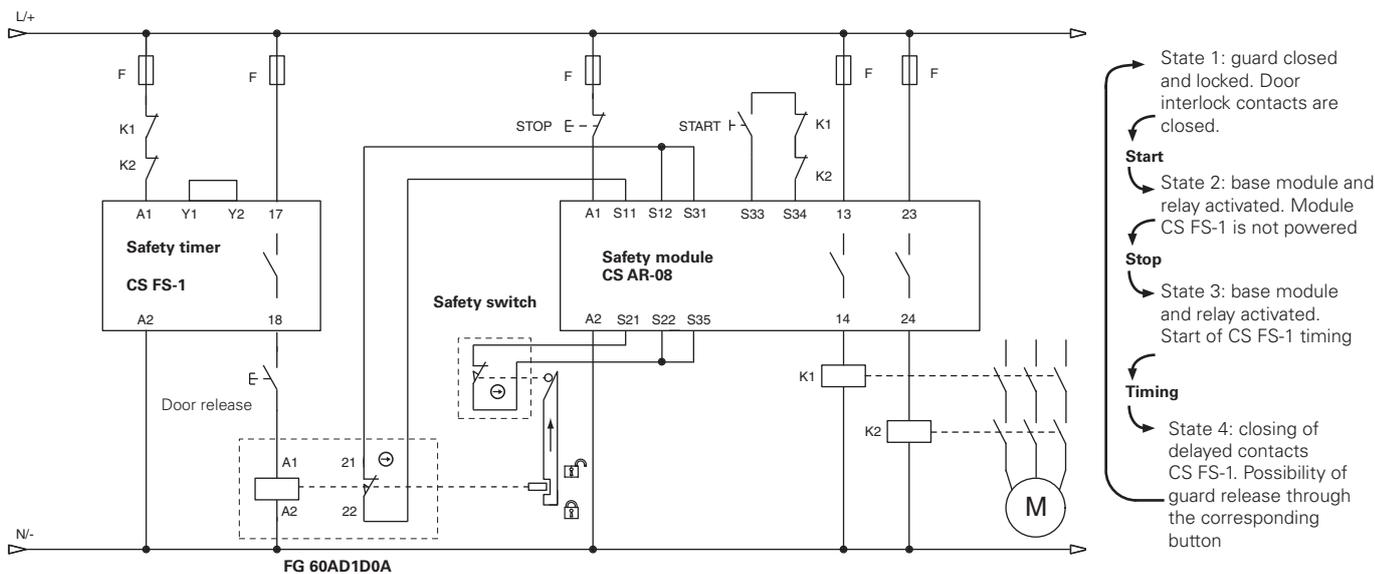

The diagram illustrates the operating principle of a typical circuit for monitoring a door-lock system with interlock in the de-energised state and manual release of the individual doors. For the complete electrical wiring diagrams with various types of electrical locking and release of the doors, please contact our technical office.

The diagram does not show the exact position of the terminals in the product



### Safety timer module with delayed contacts at energizing

#### Main features

- For safety applications up to SIL CL 2/PL d
- Timing circuits by means of safety system with self-monitoring and redundancy
- Release command for interlocked safety devices
- 45 mm housing
- Output contacts:  
1 NO safety contact, 1 NC auxiliary contact, 1 CO auxiliary contact
- Supply voltage:  
24 Vdc, 120 Vac

#### Utilization categories

Alternating current: AC15 (50...60 Hz)

U<sub>e</sub> (V) 230

I<sub>e</sub> (A) 3

Direct current: DC13 (6 oper. cycles/min.)

U<sub>e</sub> (V) 24

I<sub>e</sub> (A) 4

#### Quality marks:



EC type examination certificate: M6A 170575157017

UL approval: E131787

CCC approval: 2013010305640211

TÜV SÜD approval: Z10 17 05 75157 016

EAC approval: RU C-IT.YT03.B.00035/19

#### Compliance with the requirements of:

Machinery Directive 2006/42/EC, EMC Directive 2014/30/EC, RoHS Directive 2011/65/EU.

### Technical data

#### Housing

Polyamide housing PA 66, self-extinguishing V0 acc. to UL 94

Protection degree acc. to EN 60529:

IP40 (housing), IP20 (terminal strip)

Dimensions:

see page 317, design C

#### General data

SIL level (SIL CL) up to:

SIL CL 2 acc. to EN 62061

Performance Level (PL) up to:

PL d acc. to EN ISO 13849-1

Safety category up to:

cat. 3 acc. to EN ISO 13849-1

Safety parameters:

see page 375

Ambient temperature:

-25°C...+55°C

Mechanical endurance:

>10 million operating cycles

Electrical endurance:

>100,000 operating cycles

Pollution degree:

external 3, internal 2

Rated impulse withstand voltage (U<sub>imp</sub>):

4 kV

Rated insulation voltage (U<sub>i</sub>):

250 V

Overtoltage category:

II

#### Supply

Rated supply voltage (U<sub>n</sub>):

24 Vdc (A1-A2)

120 Vac; 50...60 Hz (B1-B2)

Max. DC residual ripple in DC:

10%

Supply voltage tolerance:

±15% of U<sub>n</sub>

Power consumption AC:

< 5 VA

Power consumption DC:

< 2 W

#### Control circuit

Protection against short circuits:

PTC resistance, I<sub>h</sub>=0.5 A

PTC times:

response time > 100 ms, release time > 3 s

Response time t<sub>A</sub>:

see "Code structure"

Release time in absence of power supply t<sub>R</sub>:

< 100 ms

#### In compliance with standards:

EN 60204-1, EN ISO 13855, EN 1037, EN ISO 12100, EN ISO 13850, EN 60529, EN 61000-6-2, EN 61000-6-3, EN 61326-1, EN 60664-1, EN 60947-1, EN 50581, EN ISO 13849-1, EN ISO 13849-2, EN 62061, UL 508, CSA C22.2 n° 14-95, GB/T14048.5-2017

#### Output circuit

Output contacts:

1 NO safety contact,

1 NC auxiliary contact,

1 CO auxiliary contact,

forcibly guided

silver alloy

Contact type:

Material of the contacts:

Maximum switching voltage:

230/240 Vac; 300 Vdc

Max. current per contact:

6 A

Conventional free air thermal current I<sub>th</sub>:

6 A

Max. total current Σ I<sub>th</sub><sup>2</sup>:

36 A<sup>2</sup>

Minimum current:

10 mA

Contact resistance:

≤ 100 mΩ

External protection fuse:

4 A

Error signal output (Y14):

Type: PNP

Rated operating voltage (U<sub>o</sub>):

24 Vdc

Rated operating current (I<sub>e</sub>):

10 mA

The number and the load capacity of output contacts can be increased by using expansion modules or contactors. See pages 263-272.

### Code structure

article options  
**CS FS-20VU24-TFxx**

#### Response time (t<sub>A</sub>)

<b>0</b>	Fixed time (see Tfx)
<b>1</b>	0.3 ... 3 s, 0.3 s steps
<b>2</b>	1 ... 10 s, 1 s steps
<b>3</b>	3 ... 30 s, 3 s steps
<b>4</b>	30 ... 300 s, 30 s steps

#### Response time (t<sub>A</sub>)

<b>TFxx</b>	xx = S (fixed time)
-------------	------------------------

#### Connection type

<b>V</b>	Screw terminals
<b>M</b>	Connector with screw terminals
<b>X</b>	Connector with spring terminals

#### Supply voltage

<b>U24</b>	24 Vdc
<b>120</b>	24 Vdc (A1-A2) 120 Vac (B1-B2)

### Features approved by UL

Rated supply voltage (U<sub>n</sub>): 24 Vdc; 120 Vac; 50...60 Hz  
Power consumption AC: < 5 VA  
Power consumption DC: < 2 W  
Electrical ratings: 230/240 Vac  
6 A general use  
C300 pilot duty

#### Notes:

- Use 60 or 75°C copper (Cu) conductor and wire size No. 30-12 AWG, stranded or solid.  
- The terminal tightening torque of 5-7 lb in.  
- Only for 24 Vac/dc versions: supply from remote Class 2 source or limited voltage limited energy.

### Features approved by TÜV SÜD

Rated supply voltage (U<sub>n</sub>): 24 Vdc; ± 15%, 120 Vac ± 15%  
Power consumption: 5 VA max AC, 2 W max DC  
Rated operating current (max.): 4 A  
Maximum switching load (max.): 1380 VA  
Ambient temperature: -25°C ... +55°C  
Storage temperature: -25 °C ... + 70°C  
Protection degree: IP40 (housing), IP20 (terminal strip)  
In compliance with standards: 2006/42/EC Machinery Directive, EN ISO 13849-1:2015 (fino a Cat. 3 PL d), EN 61508-1:2010 (SIL 2), EN 61508-2:2010 (SIL 2), EN 61508-3:2010 (SIL 2), EN 61508-4:2010 (SIL 2), EN 62061:2005/A2:2015 (SIL CL 2).



### Safety module CS FS-2

#### Pin assignment

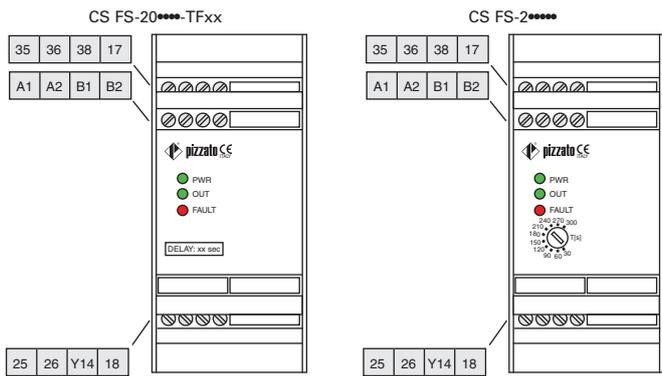

#### Function diagram

CS FS-2 Delay on Normal operation without faults

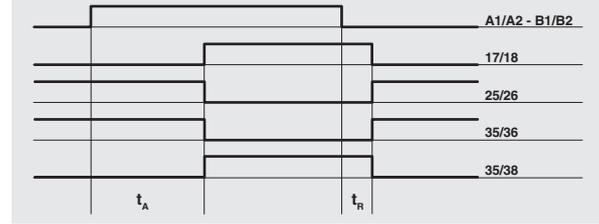

Legend:  
 $t_A$ : adjustable response time (see "Code structure")  
 $t_R$ : release time in absence of power supply

#### Internal block diagram

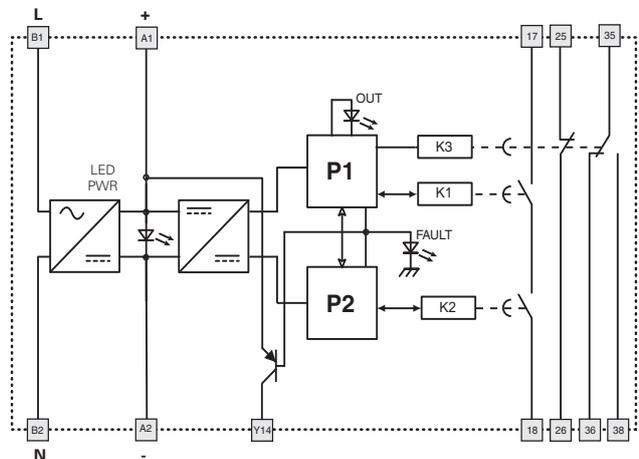

A1-A2: 24 Vdc  
 B1-B2: 120 Vac

Y14: auxiliary output, activated when the module enters fault state.



### Safety timer modules with response delay

#### Main features

- For safety applications up to SIL CL 2/PL d
- Timing circuits by means of safety system with self-monitoring and redundancy
- Release command for interlocked safety devices
- 45 mm housing
- Output contacts:  
1 NO safety contact, 1 NC auxiliary contact, 1 CO auxiliary contact
- Supply voltage:  
24 Vdc, 120 Vac

#### Utilization categories

Alternating current: AC15 (50...60 Hz)

U<sub>e</sub> (V) 230

I<sub>e</sub> (A) 3

Direct current: DC13 (6 oper. cycles/min.)

U<sub>e</sub> (V) 24

I<sub>e</sub> (A) 4

#### Quality marks:



EC type examination certificate: M6A 170575157017

UL approval: E131787

CCC approval: 2013010305640211

TÜV SÜD approval: Z10 17 05 75157 016

EAC approval: RU C-IT.YT03.B.00035/19

#### Compliance with the requirements of:

Machinery Directive 2006/42/EC,

EMC Directive 2014/30/EC,

RoHS Directive 2011/65/EU.

### Technical data

#### Housing

Polyamide housing PA 66, self-extinguishing V0 acc. to UL 94

Protection degree acc. to EN 60529:

IP40 (housing), IP20 (terminal strip)

Dimensions:

see page 317, design C

#### General data

SIL level (SIL CL) up to:

SIL CL 2 acc. to EN 62061

Performance Level (PL) up to:

PL d acc. to EN ISO 13849-1

Safety category up to:

cat. 3 acc. to EN ISO 13849-1

Safety parameters:

see page 375

Ambient temperature:

-25°C...+55°C

Mechanical endurance:

>10 million operating cycles

Electrical endurance:

>100,000 operating cycles

Pollution degree:

external 3, internal 2

Rated impulse withstand voltage (U<sub>imp</sub>):

4 kV

Rated insulation voltage (U<sub>i</sub>):

250 V

Overvoltage category:

II

#### Supply

Rated supply voltage (U<sub>n</sub>):

24 Vdc (A1-A2)

120 Vac; 50...60 Hz (B1-B2)

Max. DC residual ripple in DC:

10%

Supply voltage tolerance:

±15% of U<sub>n</sub>

Power consumption AC:

< 5 VA

Power consumption DC:

< 2 W

#### Control circuit

Protection against short circuits:

PTC resistance, I<sub>h</sub>=0.5 A

PTC times:

response time > 100 ms, release time > 3 s

Release time t<sub>A</sub>:

see "Code structure"

Release time in absence of power supply t<sub>R</sub>:

< 100 ms

Start-up time t<sub>S</sub>:

< 200 ms

#### In compliance with standards:

EN 60204-1, EN ISO 13855, EN 1037, EN ISO 12100, EN ISO 13850, EN ISO 13859, EN 61000-6-2, EN 61000-6-3, EN 61326-1, EN 60664-1, EN 60947-1, EN 50581, EN ISO 13849-1, EN ISO 13849-2, EN ISO 62061, UL 508, CSA C22.2 n° 14-95, GB/T14048.5-2017

#### Output circuit

Output contacts:

1 NO safety contact,  
1 NC auxiliary contact,  
1 CO auxiliary contact,  
forcibly guided

Contact type:

silver alloy

Material of the contacts:

230/240 Vac; 300 Vdc

Maximum switching voltage:

6 A

Max. current per contact:

6 A

Conventional free air thermal current I<sub>th</sub>:

36 A<sup>2</sup>

Max. total current Σ I<sub>th</sub><sup>2</sup>:

10 mA

Minimum current:

Contact resistance:

≤ 100 mΩ

External protection fuse:

4 A

Error signal output (Y14):

Type: PNP

Rated operating voltage (U<sub>o</sub>):

24 Vdc

Rated operating current (I<sub>o</sub>):

10 mA

The number and the load capacity of output contacts can be increased by using expansion modules or contactors. See pages 263-272.

### Code structure

article options  
**CS FS-30VU24-TFxx**

#### Release time (t<sub>A</sub>)

<b>0</b>	Fixed time (see Tfx)
<b>1</b>	0.3 ... 3 s, 0.3 s steps
<b>2</b>	1 ... 10 s, 1 s steps
<b>3</b>	3 ... 30 s, 3 s steps
<b>4</b>	30 ... 300 s, 30 s steps

#### Release time (t<sub>A</sub>)

**TFxx** xx = s (fixed time)

#### Connection type

<b>V</b>	Screw terminals
<b>M</b>	Connector with screw terminals
<b>X</b>	Connector with spring terminals

#### Supply voltage

<b>U24</b>	24 Vdc
<b>120</b>	24 Vdc (A1-A2) 120 Vac (B1-B2)

### Features approved by UL

Rated supply voltage (U<sub>n</sub>): 24 Vdc; 120 Vac; 50...60 Hz  
Power consumption AC: < 5 VA  
Power consumption DC: < 2 W  
Electrical ratings:  
230/240 Vac  
6 A general use  
C300 pilot duty

#### Notes:

- Use 60 or 75°C copper (Cu) conductor and wire size No. 30-12 AWG, stranded or solid.
- The terminal tightening torque of 5-7 lb in.
- Only for 24 Vac/dc versions: supply from remote Class 2 source or limited voltage limited energy.

### Features approved by TÜV SÜD

Rated supply voltage (U<sub>n</sub>): 24 Vdc; ± 15%, 120 Vac ± 15%  
Power consumption: 5 VA max AC, 2 W max DC  
Rated operating current (max.): 4 A  
Maximum switching load (max.): 1380 VA  
Ambient temperature: -25°C ... +55°C  
Storage temperature: -25 °C ... +70°C  
Protection degree: IP40 (housing), IP20 (terminal strip)  
In compliance with standards: 2006/42/EC Machinery Directive, EN ISO 13849-1:2015 (fino a Cat. 3 PL d), EN 61508-1:2010 (SIL 2), EN 61508-2:2010 (SIL 2), EN 61508-3:2010 (SIL 2), EN 61508-4:2010 (SIL 2), EN 62061:2005/A2:2015 (SIL CL 2).



# Safety module CS FS-3

## Pin assignment

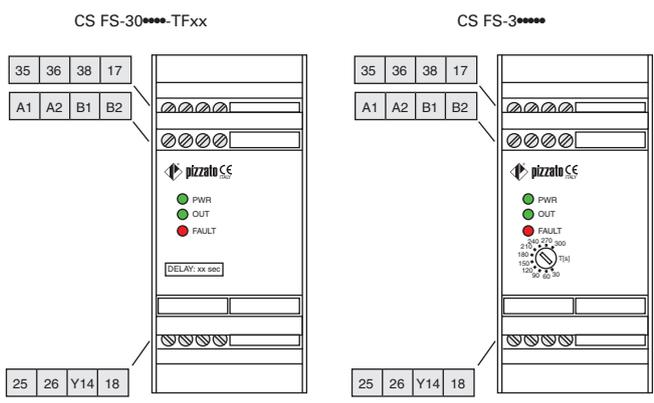

## Internal block diagram

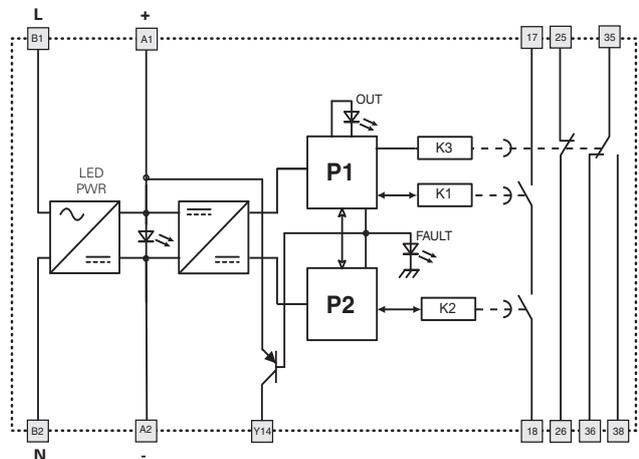

A1-A2: 24 Vdc  
 B1-B2: 120 Vac

Y14: auxiliary output, activated when the module enters fault state.

## Function diagram

CS FS-3\*\*\*\* Delay off  
 Normal operation without faults

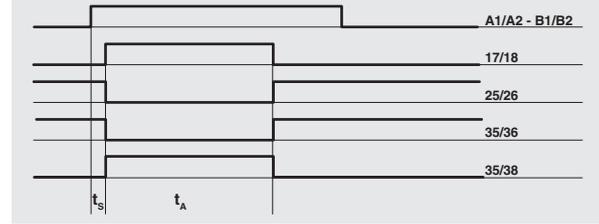

Operation without power supply

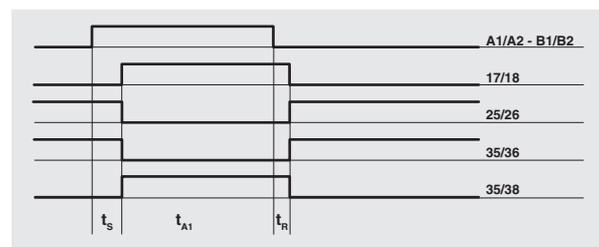

Legend:  
 $t_A$ : release time (see "Code structure")  
 $t_{A1}$ : release time if duration of power supply is less than  $t_A$   
 $t_R$ : release time in absence of power supply  
 $t_S$ : start-up time



### Safety timer module with delayed contacts upon opening of the inputs

#### Main features

- For safety applications up to SIL CL 2/PL d
- Timing circuits by means of safety system with self-monitoring and redundancy
- Release command for interlocked safety devices
- 45 mm housing
- Output contacts:  
1 NO safety contact, 1 NC auxiliary contact, 1 CO auxiliary contact,
- Supply voltage:  
24 Vdc, 120 Vac

#### Utilization categories

Alternating current: AC15 (50...60 Hz)

U<sub>e</sub> (V) 230

I<sub>e</sub> (A) 3

Direct current: DC13 (6 oper. cycles/min.)

U<sub>e</sub> (V) 24

I<sub>e</sub> (A) 4

#### Quality marks:



EC type examination certificate: M6A 170575157017

UL approval: E131787

CCC approval: 2013010305640211

TÜV SÜD approval: Z10 17 05 75157 016

EAC approval: RU C-IT.YT03.B.00035/19

#### Compliance with the requirements of:

Machinery Directive 2006/42/EC,

EMC Directive 2014/30/EC,

RoHS Directive 2011/65/EU.

## Technical data

### Housing

Polyamide housing PA 66, self-extinguishing V0 acc. to UL 94

Protection degree acc. to EN 60529:

IP40 (housing), IP20 (terminal strip)

Dimensions:

see page 317, design C

### General data

SIL level (SIL CL) up to:

SIL CL 2 acc. to EN 62061

Performance Level (PL) up to:

PL d acc. to EN ISO 13849-1

Safety category up to:

cat. 3 acc. to EN ISO 13849-1

Safety parameters:

see page 375

Ambient temperature:

-25°C...+55°C

Mechanical endurance:

>10 million operating cycles

Electrical endurance:

>100,000 operating cycles

Pollution degree:

external 3, internal 2

Rated impulse withstand voltage (U<sub>imp</sub>):

4 kV

Rated insulation voltage (U<sub>i</sub>):

250 V

Oversvoltage category:

II

### Supply

Rated supply voltage (U<sub>n</sub>):

24 Vdc (A1-A2)

120 Vac; 50...60 Hz (B1-B2)

Max. DC residual ripple in DC:

10%

Supply voltage tolerance:

±15% of U<sub>n</sub>

Power consumption AC:

< 5 VA

Power consumption DC:

< 2 W

### Control circuit

Protection against short circuits:

PTC resistance, I<sub>h</sub>=0.5 A

PTC times:

response time > 100 ms, release time > 3 s

Release time t<sub>A</sub>:

see "Code structure"

Release time in absence of power supply t<sub>R</sub>:

< 100 ms

### Input circuit

Maximum resistance per input:

≤ 50 Ω

Current per input:

< 8 mA

Response time t<sub>S</sub>:

< 150 ms

Min. duration input signal t<sub>MIN</sub>:

> 100 ms

### In compliance with standards:

EN 60204-1, EN ISO 13855, EN 1037, EN ISO 12100, EN ISO 13850, EN 60529, EN 61000-6-2, EN 61000-6-3, EN 61326-1, EN 60664-1, EN 60947-1, EN 50581, EN ISO 13849-1, EN ISO 13849-2, EN 62061, UL 508, CSA C22.2 n° 14-95, GB/T14048.5-2017

### Output circuit

Output contacts:

1 NO safety contact,

1 NC auxiliary contact,

1 CO auxiliary contact,

forcibly guided

silver alloy

Contact type:

Material of the contacts:

Maximum switching voltage:

230/240 Vac; 300 Vdc

Max. current per contact:

6 A

Conventional free air thermal current I<sub>th</sub>:

6 A

Max. total current Σ I<sub>th</sub><sup>2</sup>:

36 A<sup>2</sup>

Minimum current:

10 mA

Contact resistance:

≤ 100 mΩ

External protection fuse:

4 A

Error signal output (Y14):

Type: PNP

Rated operating voltage (U<sub>o</sub>):

24 Vdc

Rated operating current (I<sub>o</sub>):

10 mA

The number and the load capacity of output contacts can be increased by using expansion modules or contactors. See pages 263-272.

## Code structure

article options  
**CS FS-50VU24-TFxx**

Release time (t <sub>A</sub> )	
0	Fixed time (see Tfx)
1	0.3 ... 3 s, 0.3 s steps
2	1 ... 10 s, 1 s steps
3	3 ... 30 s, 3 s steps
4	30 ... 300 s, 30 s steps

Release time (t <sub>A</sub> )	
TFxx	xx = s (fixed time)

Connection type	
V	Screw terminals
M	Connector with screw terminals
X	Connector with spring terminals

Supply voltage	
U24	24 Vdc
	24 Vdc (A1-A2)
120	120 Vac (B1-B2)

### Features approved by UL

Rated supply voltage (U<sub>i</sub>): 24 Vdc; 120 Vac; 50...60 Hz  
Power consumption AC: < 5 VA  
Power consumption DC: < 2 W  
Electrical ratings:  
230/240 Vac  
6 A general use  
C300 pilot duty

#### Notes:

- Use 60 or 75°C copper (Cu) conductor and wire size No. 30-12 AWG, stranded or solid.
- The terminal tightening torque of 5-7 lb in.
- Only for 24 Vac/dc versions: supply from remote Class 2 source or limited voltage limited energy.

### Features approved by TÜV SÜD

Rated supply voltage (U<sub>i</sub>): 24 Vdc; ± 15%, 120 Vac ± 15%  
Power consumption: 5 VA max AC, 2 W max DC  
Rated operating current (max.): 4 A  
Maximum switching load (max.): 1380 VA  
Ambient temperature: -25°C ... +55°C  
Storage temperature: -25 °C ... +70°C  
Protection degree: IP40 (housing), IP20 (terminal strip)  
In compliance with standards: 2006/42/EC Machinery Directive, EN ISO 13849-1:2015 (fino a Cat. 3 PL d), EN 61508-1:2010 (SIL 2), EN 61508-2:2010 (SIL 2), EN 61508-3:2010 (SIL 2), EN 61508-4:2010 (SIL 2), EN 62061:2005/A2:2015 (SIL CL 2).

## Safety module CS FS-5

### Pin assignment

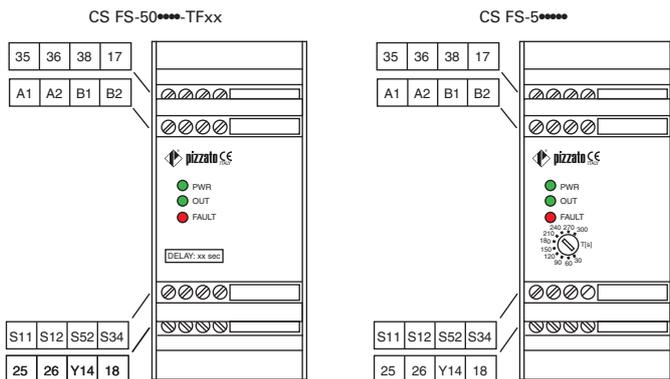

### Function diagram

#### Configuration with automatic start

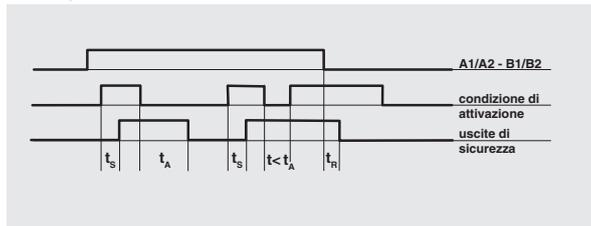

#### Configuration with manual start

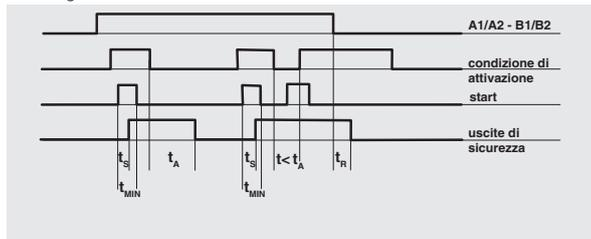

#### Legend:

- $t_A$ : release time (see "Code structure")
- $t_R$ : release time in absence of power supply
- $t_s$ : response time
- $t_{MIN}$ : min. duration input signal

### Internal block diagram

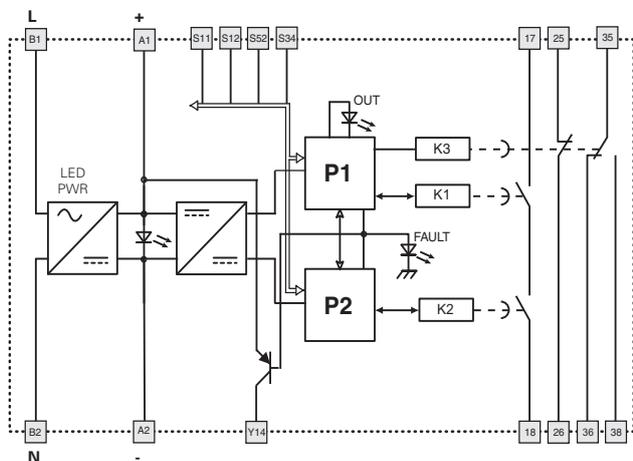

A1-A2: 24 Vdc  
B1-B2: 120 Vac

Y14: auxiliary output, activated when the module enters fault state.

### Input configuration

Movable guard monitoring	
Input configuration with manual start	
1 channel	2 channels

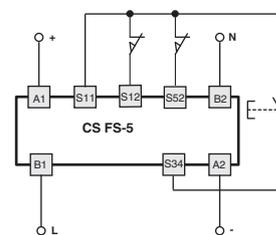
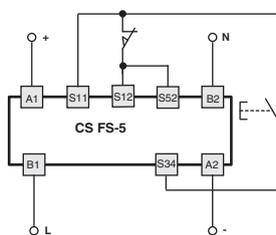

The diagram does not show the exact position of the terminals in the product

#### Automatic start

With regard to the indicated diagrams, bridge the start button between S33 and S34 in order to activate the automatic start module.

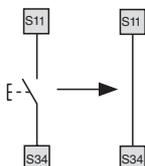

#### Monitoring of movable guards and magnetic safety sensors

The safety module can monitor control circuits for movable guards as well as magnetic safety sensors. To do this, the switch contacts must be replaced with sensors.

The sensors can only be used in 2-channel configuration.

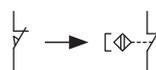



**Two-hand control device according to EN 574: type III C or safety module with synchronism control**

#### Main features

- For safety applications up to SIL CL 3/PL e
- Two-channel inputs for two-hand control device or movable guards
- Connection of input channels of opposite potentials
- Reduced housing width of 22.5 mm
- 3 NO safety contacts, 1 NC auxiliary contact
- Supply voltage: 24 Vac/dc, 120 Vac, 230 Vac

#### Utilization categories

Alternating current: AC15 (50...60 Hz)

U<sub>e</sub> (V) 230

I<sub>e</sub> (A) 3

Direct current: DC13 (6 oper. cycles/min.)

U<sub>e</sub> (V) 24

I<sub>e</sub> (A) 4

#### Quality marks:



EC type examination certificate: IMQ BP 210 DM

UL approval: E131787

CCC approval: 2013010305640211

EAC approval: RU C-IT.YT03.B.00035/19

#### Compliance with the requirements of:

Machinery Directive 2006/42/EC,

EMC Directive 2014/30/EC,

RoHS Directive 2011/65/EU.

#### Technical data

##### Housing

Polyamide housing PA 66, self-extinguishing V0 acc. to UL 94

Protection degree acc. to EN 60529:

IP40 (housing), IP20 (terminal strip)

Dimensions:

see page 317, design A

##### General data

SIL level (SIL CL) up to:

SIL CL 3 acc. to EN 62061

Performance Level (PL) up to:

PL e acc. to EN ISO 13849-1

Safety category up to:

cat. 4 acc. to EN ISO 13849-1

Type of two-hand control device:

EN 574: type III C

Safety parameters:

see page 375

Ambient temperature:

-25°C...+55°C

Mechanical endurance:

>10 million operating cycles

Electrical endurance:

>100,000 operating cycles

Pollution degree:

external 3, internal 2

Rated impulse withstand voltage (U<sub>imp</sub>):

4 kV

Rated insulation voltage (U<sub>i</sub>):

250 V

Overvoltage category:

II

##### Supply

Rated supply voltage (U<sub>n</sub>):

24 Vac/dc; 50...60 Hz

120 Vac; 50...60 Hz

230 Vac; 50...60 Hz

Max. DC residual ripple in DC:

10%

Supply voltage tolerance:

±15% of U<sub>n</sub>

Power consumption AC:

< 5 VA

Power consumption DC:

< 2 W

##### Control circuit

Protection against short circuits:

PTC resistance, I<sub>h</sub>=0.5 A

PTC times:

Response time > 100 ms, release time > 3 s

Maximum resistance per input:

≤ 50 Ω

Current per input:

30 mA (typical)

Response time t<sub>A</sub>:

< 50 ms

Release time t<sub>R1</sub>:

< 20 ms

Release time in absence of power supply t<sub>R2</sub>:

< 70 ms

Time range for synchronised actuation t<sub>SN</sub>:

< 0.5 s

#### In compliance with standards:

EN 60204-1, EN ISO 13855, EN 1037, EN ISO 12100, EN ISO 13850, EN 60529, EN 61000-6-2, EN 61000-6-3, EN 61326-1, EN 60664-1, EN 60947-1, EN 50581, EN ISO 13849-1, EN ISO 13849-2, EN 62061, UL 508, CSA C22.2 n° 14-95, GB/T14048.5-2017

##### Output circuit

Output contacts:

3 NO safety contacts,

1 NC auxiliary contact

Contact type:

forcibly guided

Material of the contacts:

gold-plated silver alloy

Maximum switching voltage:

230/240 Vac; 300 Vdc

Max. current per contact:

6 A

Conventional free air thermal current I<sub>th</sub>:

6 A

Max. total current Σ I<sub>th</sub><sup>2</sup>:

64 A<sup>2</sup>

Minimum current:

10 mA

Contact resistance:

≤ 100 mΩ

External protection fuse:

4 A

The number and the load capacity of output contacts can be increased by using expansion modules or contactors. See pages 263-272.

#### Code structure

## CS DM-01V024

Connection type	
<b>V</b>	Screw terminals
<b>M</b>	Connector with screw terminals
<b>X</b>	Connector with spring terminals

Supply voltage	
<b>024</b>	24 Vac/dc
<b>120</b>	120 Vac
<b>230</b>	230 Vac

#### Features approved by UL

Rated supply voltage (U <sub>n</sub> ):	24 Vac/dc; 50...60 Hz
	120 Vac; 50...60 Hz
	230 Vac; 50...60 Hz
Power consumption AC:	< 5 VA
	< 2 W
Power consumption DC:	< 2 W
	< 2 W
Electrical ratings:	230/240 Vac
	6 A general use C300 pilot duty

#### Notes:

- Use 60 or 75°C copper (Cu) conductor and wire size No. 30-12 AWG, stranded or solid.

- The terminal tightening torque of 5-7 lb in.

- Only for 24 Vac/dc versions: supply from remote Class 2 source or limited voltage limited energy.





### Safety module CS DM-01

#### Pin assignment

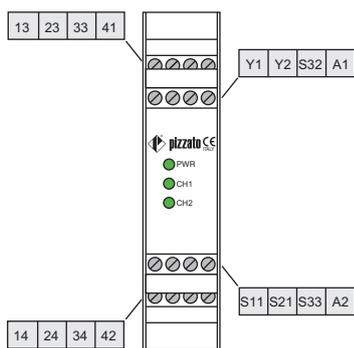

#### Function diagram

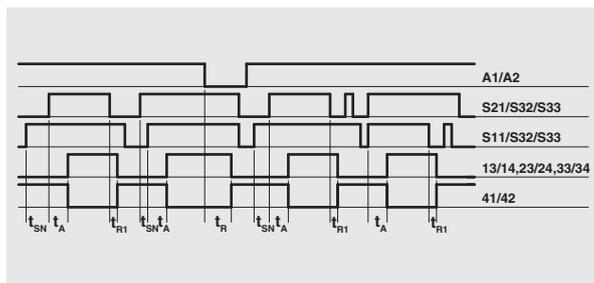

Legend:  
 $t_{SN}$ : time range for synchronised actuation  
 $t_A$ : response time  
 $t_{R1}$ : release time  
 $t_R$ : release time in absence of power supply

#### Internal block diagram

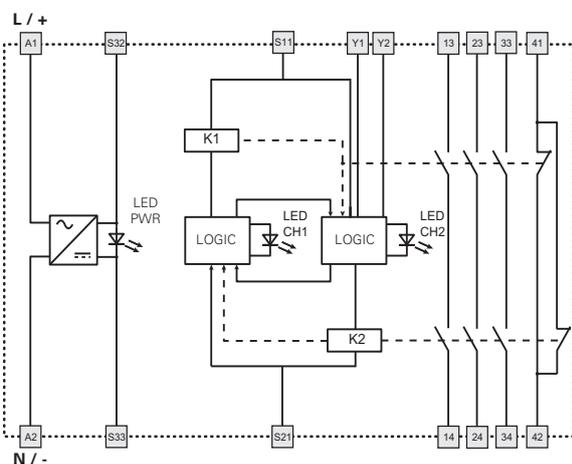

Application example on page 276.

#### Input configuration

Circuit with two-hand control device type III C according to EN 574

Movable guard monitoring with automatic start and simultaneity between channels < 0.5 s (safety category 4)

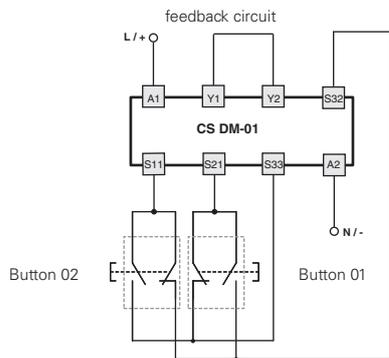

The diagram does not show the exact position of the terminals in the product

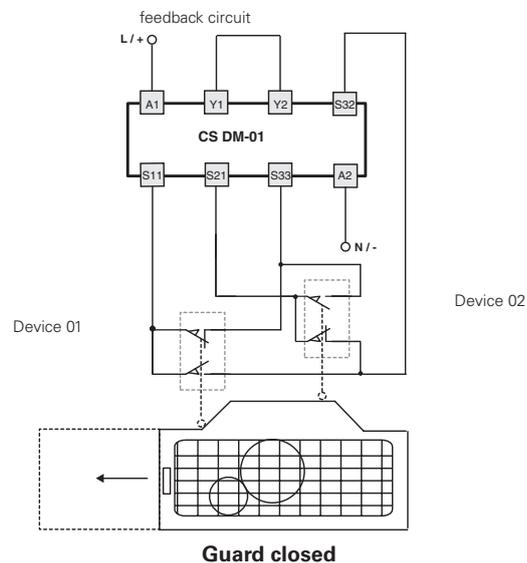



### Two-hand control device according to EN 574: type III C or safety module with synchronism control

#### Main features

- For safety applications up to SIL CL 3/PL e
- Two-channel inputs for two-hand control device or movable guards
- Connection of input channels of opposite potentials
- Reduced housing width of 22.5 mm
- 2 NO safety contacts
- Supply voltage: 24 Vac/dc, 120 Vac, 230 Vac

#### Utilization categories

Alternating current: AC15 (50...60 Hz)

U<sub>e</sub> (V) 230

I<sub>e</sub> (A) 3

Direct current: DC13 (6 oper. cycles/min.)

U<sub>e</sub> (V) 24

I<sub>e</sub> (A) 4

#### Quality marks:



EC type examination certificate: IMQ BP 210 DM

UL approval: E131787

CCC approval: 2013010305640211

EAC approval: RU C-IT.YT03.B.00035/19

#### Compliance with the requirements of:

Machinery Directive 2006/42/EC,

EMC Directive 2014/30/EC,

RoHS Directive 2011/65/EU.

#### Technical data

##### Housing

Polyamide housing PA 66, self-extinguishing V0 acc. to UL 94

Protection degree acc. to EN 60529:

IP40 (housing), IP20 (terminal strip)

Dimensions:

see page 317, design A

##### General data

SIL level (SIL CL) up to:

SIL CL 3 acc. to EN 62061

Performance Level (PL) up to:

PL e acc. to EN ISO 13849-1

Safety category up to:

cat. 4 acc. to EN ISO 13849-1

Type of two-hand control device:

EN 574: type III C

Safety parameters:

see page 375

Ambient temperature:

-25°C...+55°C

Mechanical endurance:

>10 million operating cycles

Electrical endurance:

>100,000 operating cycles

Pollution degree:

external 3, internal 2

Rated impulse withstand voltage (U<sub>imp</sub>):

4 kV

Rated insulation voltage (U<sub>i</sub>):

250 V

Overvoltage category:

II

##### Supply

Rated supply voltage (U<sub>n</sub>):

24 Vac/dc; 50...60 Hz

120 Vac; 50...60 Hz

230 Vac; 50...60 Hz

Max. DC residual ripple in DC:

10%

Supply voltage tolerance:

±15% of U<sub>n</sub>

Power consumption AC:

< 5 VA

Power consumption DC:

< 2 W

##### Control circuit

Protection against short circuits:

PTC resistance, I<sub>h</sub>=0.5 A

PTC times:

Response time > 100 ms, release time > 3 s

Maximum resistance per input:

≤ 50 Ω

Current per input:

30 mA (typical)

Response time t<sub>A</sub>:

< 30 ms

Release time t<sub>R1</sub>:

< 25 ms

Release time in absence of power supply t<sub>R2</sub>:

< 90 ms

Time range for synchronised actuation t<sub>SN</sub>:

< 0.5 s

#### In compliance with standards:

EN 60204-1, EN ISO 13855, EN 1037, EN ISO 12100, EN ISO 13850, EN 60529, EN 61000-6-2, EN 61000-6-3, EN 61326-1, EN 60664-1, EN 60947-1, EN 50581, EN ISO 13849-1, EN ISO 13849-2, EN 62061, UL 508, CSA C22.2 n° 14-95, GB/T14048.5-2017

##### Output circuit

Output contacts:

2 NO safety contacts,

Contact type:

forcibly guided

Material of the contacts:

gold-plated silver alloy

Maximum switching voltage:

230/240 Vac; 300 Vdc

Max. current per contact:

6 A

Conventional free air thermal current I<sub>th</sub>:

6 A

Max. total current Σ I<sub>th</sub><sup>2</sup>:

36 A<sup>2</sup>

Minimum current:

10 mA

Contact resistance:

≤ 100 mΩ

External protection fuse:

4 A

The number and the load capacity of output contacts can be increased by using expansion modules or contactors. See pages 263-272.

#### Code structure

## CS DM-02V024

Connection type	
<b>V</b>	Screw terminals
<b>M</b>	Connector with screw terminals
<b>X</b>	Connector with spring terminals

Supply voltage	
<b>024</b>	24 Vac/dc
<b>120</b>	120 Vac
<b>230</b>	230 Vac

#### Features approved by UL

Rated supply voltage (U <sub>n</sub> ):	24 Vac/dc; 50...60 Hz 120 Vac; 50...60 Hz 230 Vac; 50...60 Hz
Power consumption AC:	< 5 VA
Power consumption DC:	< 2 W
Electrical ratings:	230/240 Vac 6 A general use C300 pilot duty

#### Notes:

- Use 60 or 75°C copper (Cu) conductor and wire size No. 30-12 AWG, stranded or solid.
- The terminal tightening torque of 5-7 lb in.
- Only for 24 Vac/dc versions: supply from remote Class 2 source or limited voltage limited energy.



### Safety module CS DM-02

#### Pin assignment

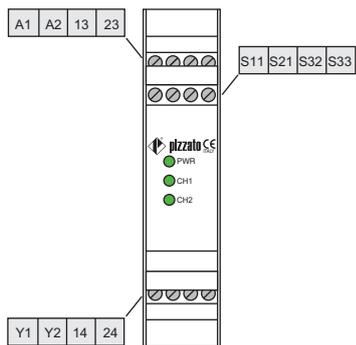

#### Function diagram

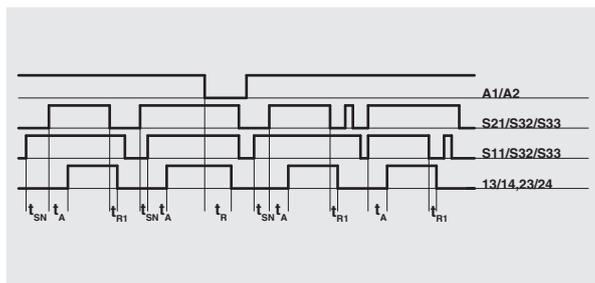

Legend:
t\_SN: time range for synchronised actuation
t\_A: response time
t\_R: release time
t\_R1: release time in absence of power supply

#### Internal block diagram

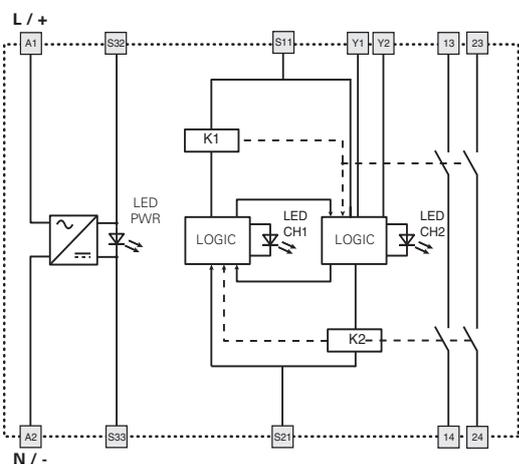

Application example on page 276.

#### Input configuration

Circuit with two-hand control device type III C according to EN 574

Movable guard monitoring with automatic start and simultaneity between channels < 0.5 s (safety category 4)

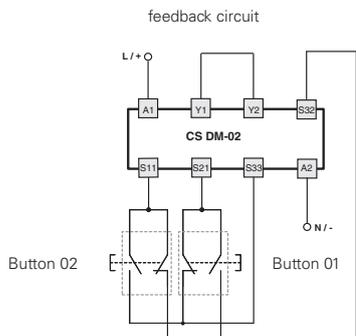

The diagram does not show the exact position of the terminals in the product

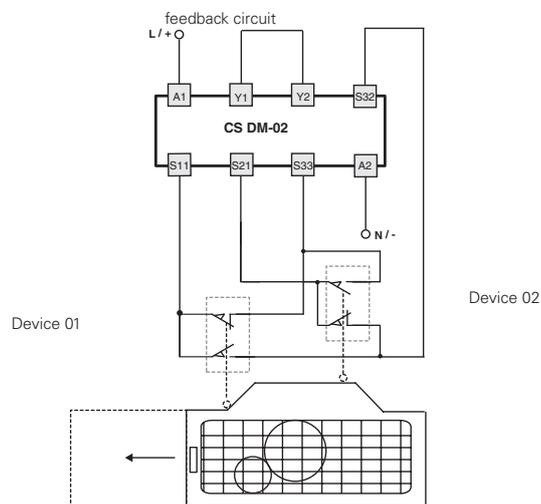

Guard closed



### Two-hand control device according to EN 574: type III A or safety module with synchronism control

#### Main features

- For safety applications up to SIL CL 1/PL c
- Two-channel inputs for two-hand control device or movable guards
- Connection of input channels of opposite potentials
- Reduced housing width of 22.5 mm
- 2 NO safety contacts,
- Supply voltage: 24 Vac/dc, 120 Vac, 230 Vac

#### Utilization categories

Alternating current: AC15 (50...60 Hz)

U<sub>e</sub> (V) 230

I<sub>e</sub> (A) 3

Direct current: DC13 (6 oper. cycles/min.)

U<sub>e</sub> (V) 24

I<sub>e</sub> (A) 4

#### Quality marks:



UL approval: E131787

CCC approval: 2013010305640211

EAC approval: RU C-IT.

YT03.B.00035/19

#### Compliance with the requirements of:

Machinery Directive 2006/42/EC,

EMC Directive 2014/30/EC,

RoHS Directive 2011/65/EU.

### Technical data

#### Housing

Polyamide housing PA 66, self-extinguishing V0 acc. to UL 94

Protection degree acc. to EN 60529:

IP40 (housing), IP20 (terminal strip)

Dimensions:

see page 317, design A

#### General data

SIL level (SIL CL) up to:

SIL CL 1 acc. to EN 62061

Performance Level (PL) up to:

PL c acc. to EN ISO 13849-1

Safety category up to:

cat. 1 acc. to EN ISO 13849-1

Type of two-hand control device:

EN 574: type III A

Safety parameters:

see page 375

Ambient temperature:

-25°C...+55°C

Mechanical endurance:

>10 million operating cycles

Electrical endurance:

>100,000 operating cycles

Pollution degree:

external 3, internal 2

Rated impulse withstand voltage (U<sub>imp</sub>):

4 kV

Rated insulation voltage (U<sub>i</sub>):

250 V

Overvoltage category:

II

#### Supply

Rated supply voltage (U<sub>n</sub>):

24 Vac/dc; 50...60 Hz

120 Vac; 50...60 Hz

230 Vac; 50...60 Hz

Max. DC residual ripple in DC:

10%

Supply voltage tolerance:

±15% of U<sub>n</sub>

Power consumption AC:

< 5 VA

Power consumption DC:

< 2 W

#### Control circuit

Protection against short circuits:

PTC resistance, I<sub>h</sub>=0.5 A

PTC times:

Response time > 100 ms, release time > 3 s

Maximum resistance per input:

≤ 100 Ω

Current per input:

32 mA (typical)

Response time t<sub>A</sub>:

< 12 ms

Release time t<sub>R</sub>:

< 10 ms

Release time in absence of power supply t<sub>R</sub>:

< 200 ms

Time range for synchronised actuation t<sub>SN</sub>:

< 0.5 s

#### In compliance with standards:

EN 60204-1, EN ISO 13855, EN 1037, EN ISO 12100, EN ISO 13850, EN 60529, EN 61000-6-2, EN 61000-6-3, EN 61326-1, EN 60664-1, EN 60947-1, EN 50581, EN ISO 13849-1, EN ISO 13849-2, EN 62061, UL 508, CSA C22.2 n° 14-95, GB/T14048.5-2017

#### Output circuit

Output contacts:

2 NO safety contacts,

Contact type:

forcibly guided

Material of the contacts:

gold-plated silver alloy

Maximum switching voltage:

230/240 Vac; 300 Vdc

Max. current per contact:

6 A

Conventional free air thermal current I<sub>th</sub>:

6 A

Max. total current Σ I<sub>th</sub><sup>2</sup>:

36 A<sup>2</sup>

Minimum current:

10 mA

Contact resistance:

≤ 100 mΩ

External protection fuse:

4 A

The number and the load capacity of output contacts can be increased by using expansion modules or contactors. See pages 263-272.

### Code structure

## CS DM-20V024

Connection type	
V	Screw terminals
M	Connector with screw terminals
X	Connector with spring terminals

Supply voltage	
024	24 Vac/dc
120	120 Vac
230	230 Vac

### Features approved by UL

Rated supply voltage (U <sub>n</sub> ):	24 Vac/dc; 50...60 Hz 120 Vac; 50...60 Hz 230 Vac; 50...60 Hz
Power consumption AC:	< 5 VA
Power consumption DC:	< 2 W
Electrical ratings:	230/240 Vac 6 A general use C300 pilot duty

#### Notes:

- Use 60 or 75°C copper (Cu) conductor and wire size No. 30-12 AWG, stranded or solid.
- The terminal tightening torque of 5-7 lb in.
- Only for 24 Vac/dc versions: supply from remote Class 2 source or limited voltage limited energy.



### Safety module CS DM-20

#### Pin assignment

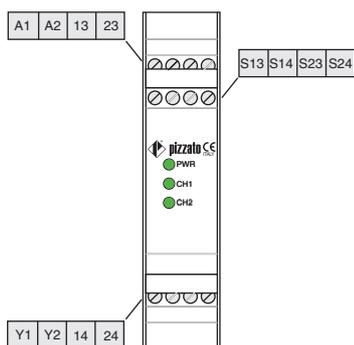

#### Function diagram

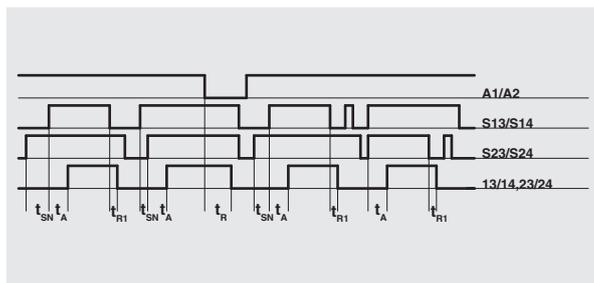

Legend:  
 $t_{SN}$ : time range for synchronised actuation  
 $t_A$ : response time  
 $t_R$ : release time  
 $t_{R1}$ : release time in absence of power supply

#### Internal block diagram

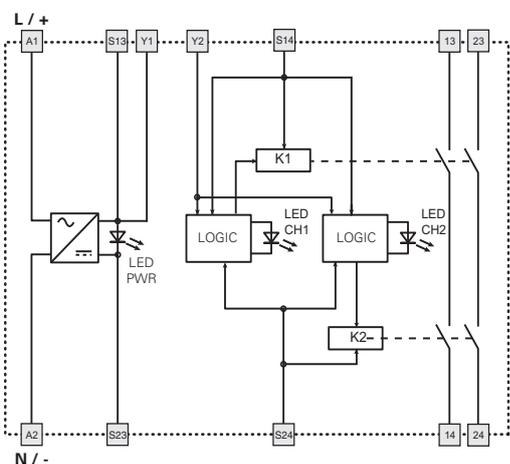

#### Input configuration

Circuit with two-hand control device type III A according to EN 574

Movable guard monitoring with automatic start and simultaneity between channels < 0.5 s

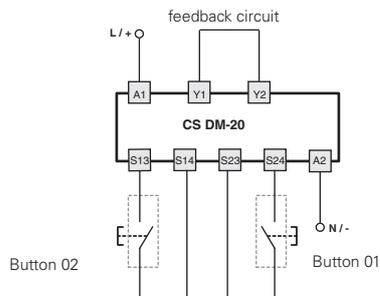

The diagram does not show the exact position of the terminals in the product

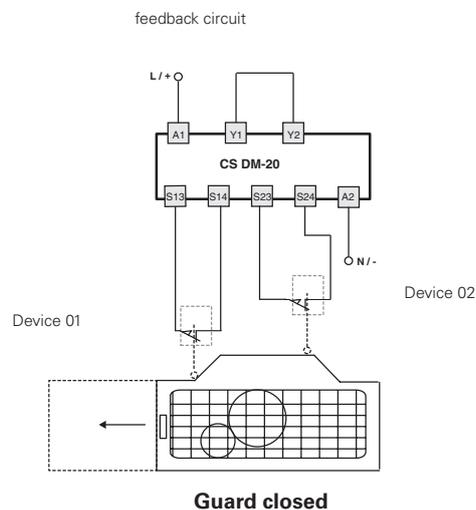



### Safety modules for motor standstill monitoring

#### Main features

- For safety applications up to SIL CL 2/PL d
- Select from 10 different residual voltages on motor standstill.
- Galvanic separation between control circuit and measurement circuit.
- 45 mm housing
- 2 NO safety contacts  
1 NC auxiliary contact
- 2 semiconductor outputs:
  - 1 signalling output for failure state
  - 1 signalling output for switching state of safety relays
- Possibility to connect single-phase or three-phase motors to measuring circuits.
- Supply voltages: 24 ... 230 Vac/dc

#### Utilization categories

Alternating current: AC15 (50...60 Hz)

U<sub>e</sub> (V) 230

I<sub>e</sub> (A) 3

Direct current: DC13 (6 oper. cycles/min.)

U<sub>e</sub> (V) 24

I<sub>e</sub> (A) 4

#### Quality marks:



EC type examination certificate: IMQ CS 487 DM

UL approval: E131787

CCC approval: 2013010305640211

EAC approval: RU C-IT.YT03.B.00035/19

#### Compliance with the requirements of:

Machinery Directive 2006/42/EC,

EMC Directive 2014/30/EC,

RoHS Directive 2011/65/EU.

### Technical data

#### Housing

Polyamide housing PA 66, self-extinguishing V0 acc. to UL 94

Protection degree acc. to EN 60529:

IP40 (housing), IP20 (terminal strip)

Dimensions:

see page 317, design C

#### General data

SIL level (SIL CL) up to:

SIL CL 2 acc. to EN 62061

Performance Level (PL) up to:

PL d acc. to EN ISO 13849-1

Safety category up to:

cat. 3 acc. to EN ISO 13849-1

Safety parameters:

see page 375

Ambient temperature:

-25°C...+55°C

Mechanical endurance:

>10 million operating cycles

Electrical endurance:

>100,000 operating cycles

Pollution degree:

external 3, internal 2

Rated impulse withstand voltage (U<sub>imp</sub>):

4 kV

Rated insulation voltage (U<sub>i</sub>):

250 V

Overvoltage category:

II

#### Supply

Rated supply voltage (U<sub>n</sub>):

24 ... 230 Vac/dc; 50...60 Hz

Max. DC residual ripple in DC:

10%

Supply voltage tolerance:

±15% of U<sub>n</sub>

Power consumption AC:

< 6 VA

Power consumption DC:

< 2 W

#### Input circuit

Voltage between terminals L1-L2-L3:

0 ... 690 V

Frequency:

0 ... 3 kHz

Input impedance:

>1 MΩ

Started motor threshold voltage:

from 20 mV to 500 mV adjustable in 10 increments

Stopped motor threshold voltage:

half the motor threshold voltage with motor in operation

Maximum input impedance Y1-Y2:

< 20 Ω

Current in START Y1-Y2 circuit:

70 mA (typical)

RESET input voltage:

24 Vdc ± 20%

RESET input current:

10 mA (typical)

#### Control circuit

Response time t<sub>A</sub>:

< 3 s

Release time t<sub>R</sub>:

< 200 ms

Release time in absence of power supply t<sub>R</sub>:

< 3 s

Simultaneity time t<sub>C1</sub>, t<sub>C2</sub>:

3 s

Test:

Self-test upon activation of the supply voltage and after activation of the RESET input.

Test duration:

2.5 s (During the test, the voltage in the measurement circuits must be less than the threshold voltage of the motor while at a standstill)

#### In compliance with standards:

EN 60204-1, EN ISO 13855, EN 1037, EN ISO 12100, EN ISO 13850, EN 60529, EN 61000-6-2, EN 61000-6-3, EN 61326-1, EN 60664-1, EN 60947-1, EN 50581, EN ISO 13849-1, EN ISO 13849-2, EN 62061, UL 508, CSA C22.2 n° 14-95, GB/T14048.5-2017

#### Output circuit

Output contacts:

2 NO safety contacts, 1 NC auxiliary contact

Contact type:

forcibly guided

Material of the contacts:

gold-plated silver alloy

Maximum switching voltage:

230/240 Vac; 300 Vdc

Max. current per contact:

6 A

Conventional free air thermal current I<sub>th</sub>:

6 A

Max. total current Σ I<sub>th</sub><sup>2</sup>:

36 A<sup>2</sup>

Minimum current:

10 mA

Contact resistance:

≤ 100 mΩ

External protection fuse:

4 A

Semiconductor outputs:

PNP outputs galvanically separated, overvoltage and short-circuit protected

Switching voltage:

24 Vdc

Switching current:

50 mA

External supply voltage:

24 Vdc ±20%

The number and the load capacity of output contacts can be increased by using expansion modules or contactors. See pages 263-272.

### Code structure

article options  
**CS AM-01VE01-TC00UR1**

Threshold voltage for motor at standstill	
	20-500 mV (standard)
<b>UR1</b>	45-750 mV

Connection type		Simultaneity time (t <sub>c</sub> )	
<b>V</b>	Screw terminals		3s (standard)
<b>M</b>	Connector with screw terminals	<b>TC00</b>	infinite at standstill (t <sub>c</sub> )
<b>X</b>	Connector with spring terminals	<b>TA00</b>	infinite on startup and standstill (t <sub>c</sub> )
		<b>TD0</b>	infinite on standstill and minimum activation time (t <sub>A</sub> )

### Features approved by UL

Rated supply voltage (U<sub>n</sub>): 24 ... 230 Vac/dc; 50 ... 60 Hz

Power consumption AC: < 9 VA

Power consumption DC: < 2 W

Relay output:

Electrical ratings: 230/240 Vac  
6 A general use  
C300 pilot duty

Semiconductor output: 24 Vdc, 50 mA

Motor input: up to 600 V

Notes:

- For use in pollution degree 2 environment

- Use 60 or 75°C copper (Cu) conductor and wire size No. 30-12 AWG, stranded or solid.

- The terminal tightening torque of 5-7 lb in.



### Safety module CS AM-0

#### Pin assignment

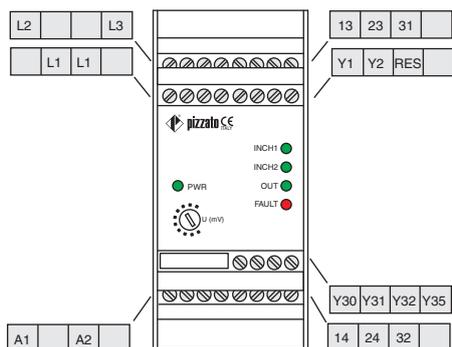

#### Internal block diagram

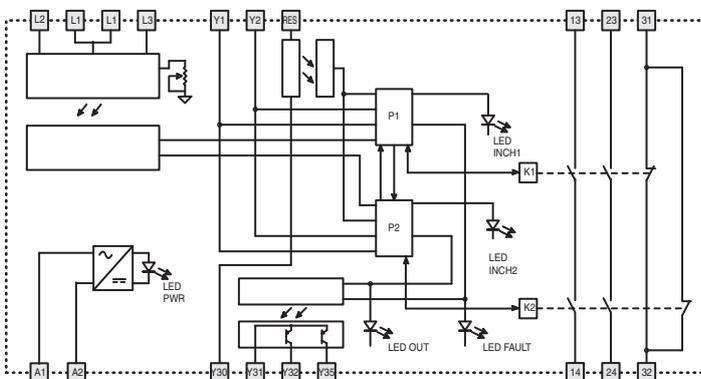

#### Function diagrams

##### Normal operation

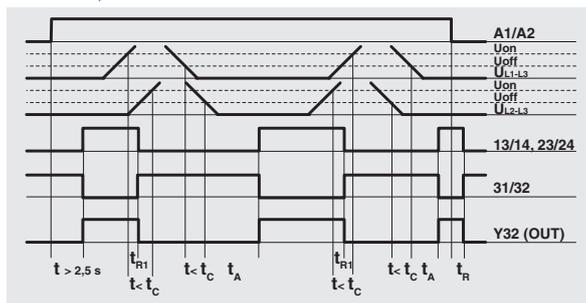

##### Reset (RES) operation

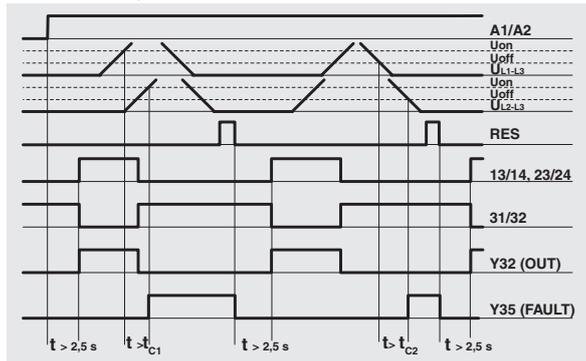

Legend:  
 $t_C$ : simultaneity time  
 $t_A$ : response time  
 $t_{R1}$ : release time  
 $t_R$ : release time in absence of power supply

#### Input configuration

##### Single-phase motor

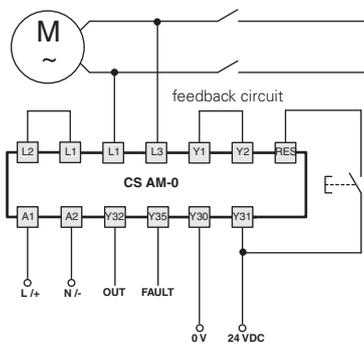

##### Three-phase motor

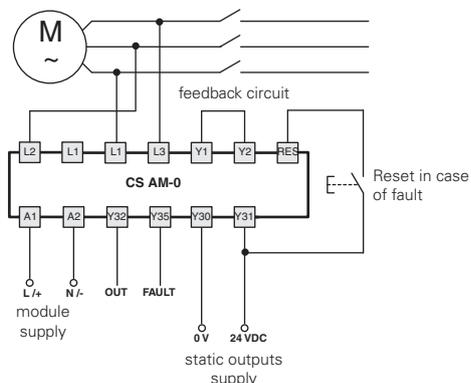

$\Delta$  In case of star/delta starting, connect the module to the ends of a single winding  
 For dc motors connect + with L1 and - with L3.  
 The diagram does not show the exact position of the terminals in the product

Application example on page 275.



### Expansion module with output contacts

#### Main features

- For safety applications up to SIL CL 3/PL e
- Possibility of control with one or two channels
- Connection of input channels of opposite potentials
- Reduced housing width of 22.5 mm
- Output contacts:
  - 5 NO safety contacts,
  - 1 NC auxiliary contact,
  - 1 NC feedback contact
- Supply voltage: 24 Vac/dc

#### Utilization categories

Alternating current: AC15 (50...60 Hz)

U<sub>e</sub> (V) 230

I<sub>e</sub> (A) 3

Direct current: DC13 (6 oper. cycles/min.)

U<sub>e</sub> (V) 24

I<sub>e</sub> (A) 4

#### Quality marks and certificates:



EC type examination certificate: IMQ CP 432 DM

UL approval: E131787

CCC approval: 2013010305640211

EAC approval: RU C-IT.YT03.B.00035/19

#### Compliance with the requirements of:

Machinery Directive 2006/42/EC,

EMC Directive 2014/30/EC,

RoHS Directive 2011/65/EU.

### Technical data

#### Housing

Polyamide housing PA 66, self-extinguishing V0 acc. to UL 94

Protection degree acc. to EN 60529:

IP40 (housing), IP20 (terminal strip)

Dimensions:

see page 317, design A

#### General data

SIL level (SIL CL) up to:

SIL CL 3 acc. to EN 62061

Performance Level (PL) up to:

PL e acc. to EN ISO 13849-1

Safety category up to:

cat. 4 acc. to EN ISO 13849-1  
(see base module category)

Safety parameters:

Ambient temperature:

see page 375

-25°C...+55°C

Mechanical endurance:

>10 million operating cycles

Electrical endurance:

>100,000 operating cycles

Pollution degree:

external 3, internal 2

Rated impulse withstand voltage (U<sub>imp</sub>):

4 kV

Rated insulation voltage (U):

250 V

Overvoltage category:

II

#### Supply

Rated supply voltage (U<sub>n</sub>):

24 Vac/dc; 50...60 Hz

Max. DC residual ripple in DC:

10%

Supply voltage tolerance:

±15% of U<sub>n</sub>

Power consumption AC:

< 5 VA

Power consumption DC:

< 2 W

#### Control circuit

Protection against short circuits:

PTC resistance, I<sub>h</sub>=0.5 A

PTC times:

Response time > 100 ms, release time > 3 s

Maximum resistance per input:

≤ 50 Ω

Response time t<sub>A</sub>:

< 40 ms

Release time in absence of power supply t<sub>R</sub>:

< 50 ms

#### In compliance with standards:

EN 60204-1, EN ISO 13855, EN 1037, EN ISO 12100, EN ISO 13850, EN 60529, EN 61000-6-2, EN 61000-6-3, EN 61326-1, EN 60664-1, EN 60947-1, EN 50581, EN ISO 13849-1, EN ISO 13849-2, EN 62061, UL 508, CSA C22.2 n° 14-95

#### Output circuit

Output contacts:

5 NO safety contacts,

1 NC auxiliary contact,

1 NC feedback contact

forcibly guided

gold-plated silver alloy

230/240 Vac; 300 Vdc

Contact type:

Material of the contacts:

Maximum switching voltage:

Max. current per contact:

Conventional free air thermal current I<sub>th</sub>:

Max. total current Σ I<sub>th</sub><sup>2</sup>:

Minimum current:

Contact resistance:

External protection fuse:

6 A

6 A

72 A<sup>2</sup>

10 mA

≤ 100 mΩ

4 A

### Code structure

## CS ME-01V024

Connection type	
V	Screw terminals
M	Connector with screw terminals
X	Connector with spring terminals

Supply voltage	
024	24 Vac/dc

### Features approved by UL

Rated supply voltage (U <sub>n</sub> ):	24 Vac/dc; 50...60 Hz
Power consumption AC:	< 5 VA
Power consumption DC:	< 2 W
Electrical ratings:	230/240 Vac 6 A general use C300 pilot duty

#### Notes:

- Use 60 or 75°C copper (Cu) conductor and wire size No. 30-12 AWG, stranded or solid.
- The terminal tightening torque of 5-7 lb.in.
- Only for 24 Vac/dc versions: supply from remote Class 2 source or limited voltage limited energy.





# CS ME-01 expansion module

## Pin assignment

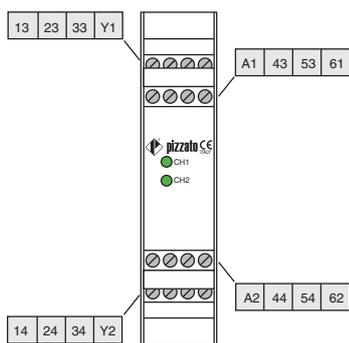

## Function diagram

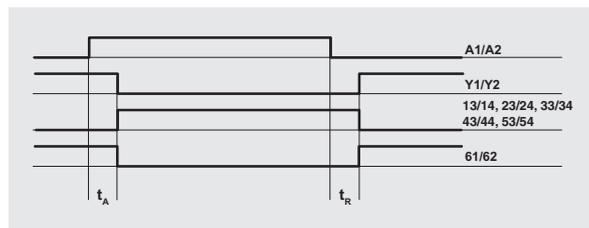

Legend:  
 $t_A$ : response time  
 $t_R$ : release time in absence of power supply

## Internal block diagram

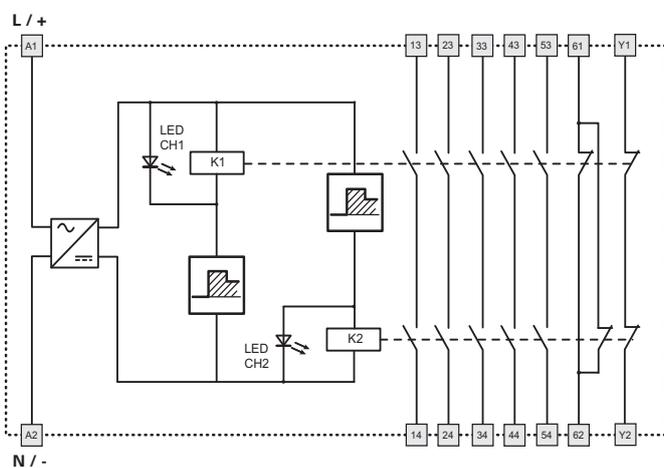

## Input configuration

### Single channel control

### Double channel control

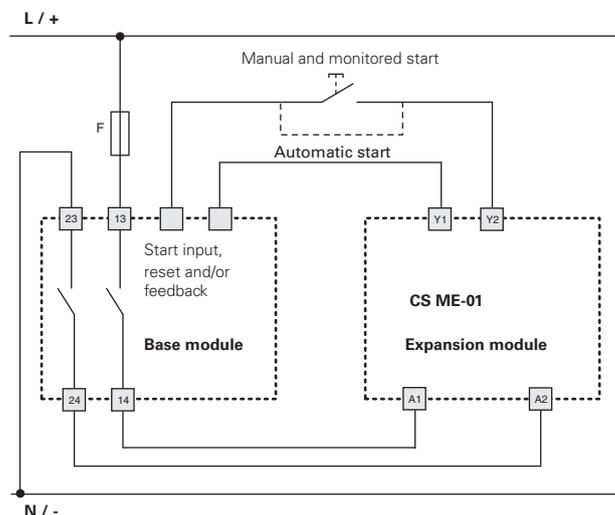
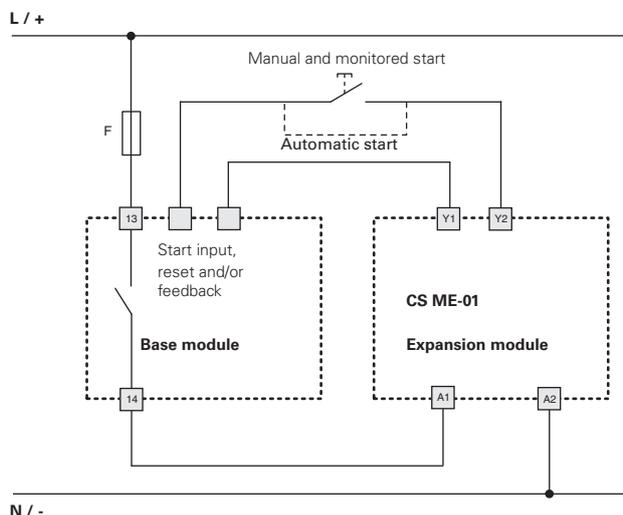

The diagram does not show the exact position of the terminals in the product



### Expansion module with output contacts

#### Main features

- For safety applications up to SIL CL 3/PL e
- Possibility of control with one or two channels
- Connection of input channels of opposite potentials
- Reduced housing width of 22.5 mm
- Output contacts:
  - 4 NO safety contacts,
  - 2 NC auxiliary contacts,
  - 1 NC feedback contact
- Supply voltage: 24 Vdc

#### Utilization categories

Alternating current: AC15 (50...60 Hz)

U<sub>e</sub> (V) 230

I<sub>e</sub> (A) 3

Direct current: DC13 (6 oper. cycles/min.)

U<sub>e</sub> (V) 24

I<sub>e</sub> (A) 4

#### Quality marks:



EC type examination certificate: IMQ CP 432 DM

UL approval: E131787

CCC approval: 2013010305640211

EAC approval: RU C-IT.YT03.B.00035/19

#### Compliance with the requirements of:

Machinery Directive 2006/42/EC,

EMC Directive 2014/30/EC,

RoHS Directive 2011/65/EU.

### Technical data

#### Housing

Polyamide housing PA 66, self-extinguishing V0 acc. to UL 94

Protection degree acc. to EN 60529:

IP40 (housing), IP20 (terminal strip)

Dimensions:

see page 317, design A

#### General data

SIL level (SIL CL) up to:

SIL CL 3 acc. to EN 62061

Performance Level (PL) up to:

PL e acc. to EN ISO 13849-1

Safety category up to:

cat. 4 acc. to EN ISO 13849-1  
(see base module category)

Safety parameters:

see page 375

Ambient temperature:

-25°C...+55°C

Mechanical endurance:

> 10 million operating cycles

Electrical endurance:

> 100,000 operating cycles

Pollution degree:

external 3, internal 2

Rated impulse withstand voltage (U<sub>imp</sub>):

4 kV

Rated insulation voltage (U<sub>i</sub>):

250 V

Overvoltage category:

II

#### Supply

Rated supply voltage (U<sub>n</sub>):

24 Vdc

Max. DC residual ripple in DC:

10%

Supply voltage tolerance:

±15% of U<sub>n</sub>

Power consumption DC:

< 2 W

#### Control circuit

Protection against short circuits:

PTC resistance, I<sub>h</sub>=0.5 A

PTC times:

Response time > 100 ms, release time > 3 s

Maximum resistance per input:

≤ 50 Ω

Response time t<sub>A</sub>:

< 100 ms

Release time in absence of power supply t<sub>R</sub>:

< 60 ms

#### In compliance with standards:

EN 60204-1, EN ISO 13855, EN 1037, EN ISO 12100, EN ISO 13850, EN 60529, EN 61000-6-2, EN 61000-6-3, EN 61326-1, EN 60664-1, EN 60947-1, EN 50581, EN ISO 13849-1, EN ISO 13849-2, EN 62061, UL 508, CSA C22.2 n° 14-95, GB/T14048.5-2017

#### Output circuit

Output contacts:

4 NO safety contacts,  
2 NC auxiliary contacts,  
1 NC feedback contact  
forcibly guided

Contact type:

gold-plated silver alloy

Material of the contacts:

230/240 Vac; 300 Vdc

Maximum switching voltage:

Max. current per contact:

6 A

Conventional free air thermal current I<sub>th</sub>:

6 A

Max. total current Σ I<sub>th</sub><sup>2</sup>:

64 A<sup>2</sup>

Minimum current:

10 mA

Contact resistance:

≤ 100 mΩ

External protection fuse:

4 A

### Code structure

## CS ME-02VU24

Connection type	
V	Screw terminals
M	Connector with screw terminals
X	Connector with spring terminals

Supply voltage	
U24	24 Vdc

### Features approved by UL

Rated supply voltage (U <sub>n</sub> ):	24 Vdc
Power consumption DC:	< 2 W
Electrical ratings:	230/240 Vac 6 A general use C300 pilot duty

#### Notes:

- Use 60 or 75°C copper (Cu) conductor and wire size No. 30-12 AWG, stranded or solid.
- The terminal tightening torque of 5-7 lb in.
- Only for 24 Vac/dc versions: supply from remote Class 2 source or limited voltage limited energy.



### CS ME-02 expansion module

#### Pin assignment

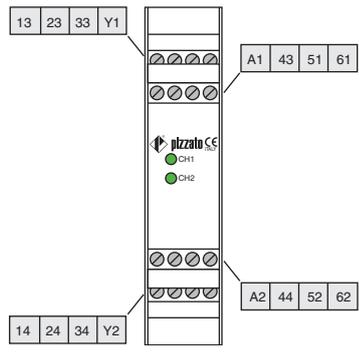

#### Function diagram

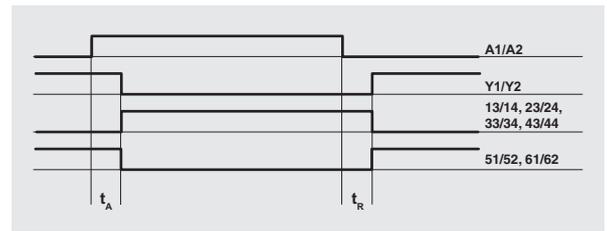

Legend:  
 $t_A$ : response time  
 $t_R$ : release time in absence of power supply

#### Internal block diagram

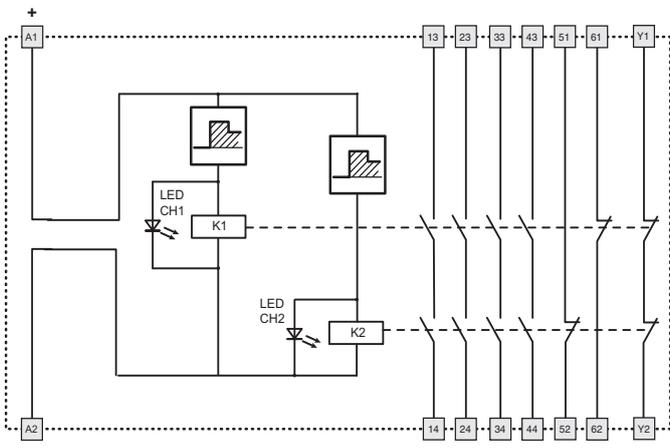

#### Input configuration

Single channel control	Double channel control
------------------------	------------------------

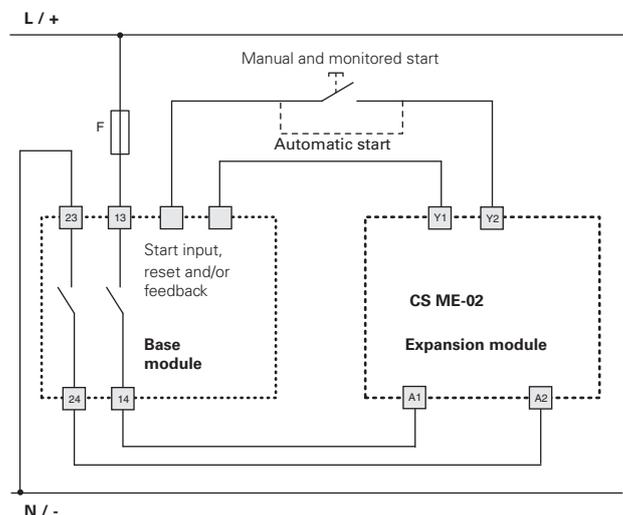
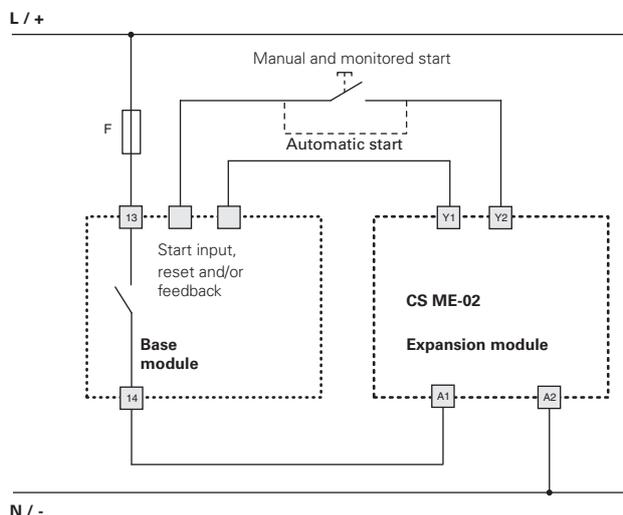

The diagram does not show the exact position of the terminals in the product

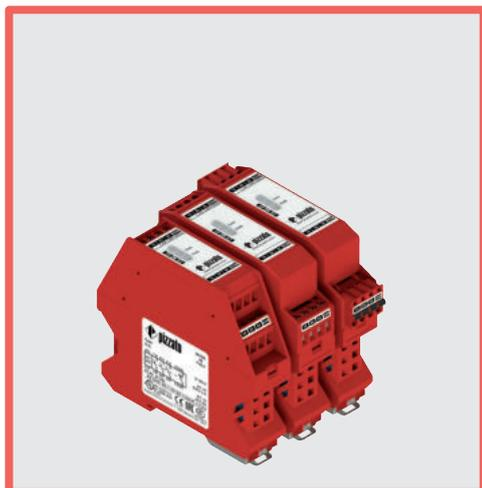

### Expansion module with output contacts

#### Main features

- For safety applications up to SIL CL 3/PL e
- Module for OSSD semiconductor outputs
- 2 OSSD inputs
- Reduced housing width of 22.5 mm
- Output contacts:  
3 NO safety contacts,  
1 NC feedback contact/EDM
- Supply voltage: 24 Vdc

#### Utilization categories

Alternating current: AC15 (50...60 Hz)

U<sub>e</sub> (V) 230

I<sub>e</sub> (A) 3

Direct current: DC13 (6 oper. cycles/min.)

U<sub>e</sub> (V) 24

I<sub>e</sub> (A) 4

#### Quality marks:



EC type examination certificate: IMQ CP 432 DM

UL approval: E131787

CCC approval: 2013010305640211

EAC approval: RU C-IT.YT03.B.00035/19

#### Compliance with the requirements of:

Machinery Directive 2006/42/EC,

EMC Directive 2014/30/EC,

RoHS Directive 2011/65/EU.

### Technical data

#### Housing

Polyamide housing PA 66, self-extinguishing V0 acc. to UL 94

Protection degree acc. to EN 60529:

IP40 (housing), IP20 (terminal strip)

Dimensions:

see page 317, design D

#### General data

SIL level (SIL CL) up to:

SIL CL 3 acc. to EN 62061

Performance Level (PL) up to:

PL e acc. to EN ISO 13849-1

Safety category up to:

cat. 4 acc. to EN ISO 13849-1  
(dependent on semiconductor outputs)

Safety parameters:

see page 375

Ambient temperature:

-25°C...+55°C

Mechanical endurance:

>10 million operating cycles

Electrical endurance:

>100,000 operating cycles

Pollution degree:

external 3, internal 2

Rated impulse withstand voltage (U<sub>imp</sub>):

4 kV

Rated insulation voltage (U<sub>i</sub>):

250 V

Oversvoltage category:

II

#### Supply

Rated supply voltage (U<sub>n</sub>):

24 Vdc

Max. DC residual ripple in DC:

10%

Supply voltage tolerance:

±15% of U<sub>n</sub>

Power consumption DC:

< 2 W

Consumption at start:

< 3 W

#### Control circuit

Response time t<sub>A</sub>:

< 40 ms

Release time t<sub>R1</sub>:

< 20 ms

#### In compliance with standards:

EN 60204-1, EN ISO 13855, EN 1037, EN ISO 12100, EN ISO 13850, EN 60529, EN 61000-6-2, EN 61000-6-3, EN 61326-1, EN 60664-1, EN 60947-1, EN 50581, EN ISO 13849-1, EN ISO 13849-2, EN 62061, UL 508, CSA C22.2 n° 14-95, GB/T14048.5-2017

#### Output circuit

Output contacts:

3 NO safety contacts,  
1 NC feedback contact

Contact type:

forcibly guided

Material of the contacts:

gold-plated silver alloy

Maximum switching voltage:

230/240 Vac; 300 Vdc

Max. current per contact:

6 A

Conventional free air thermal current I<sub>th</sub>:

6 A

Max. total current Σ I<sub>th</sub><sup>2</sup>:

36 A<sup>2</sup>

Minimum current:

10 mA

Contact resistance:

≤ 100 mΩ

External protection fuse:

4 A

### Code structure

## CS ME-03VU24

#### Connection type

**V** Screw terminals

**M** Connector with screw terminals

**X** Connector with spring terminals

#### Supply voltage

**U24** 24 Vdc

### Features approved by UL

Rated supply voltage (U<sub>n</sub>): 24 Vdc

Power consumption DC: < 2 W

Electrical ratings: 230/240 Vac

6 A general use

C300 pilot duty

#### Notes:

- Use 60 or 75°C copper (Cu) conductor and wire size No. 30-12 AWG, stranded or solid.

- The terminal tightening torque of 5-7 lb in.

- Only for 24 Vac/dc versions: supply from remote Class 2 source or limited voltage limited energy.



### CS ME-03 expansion module

#### Pin assignment

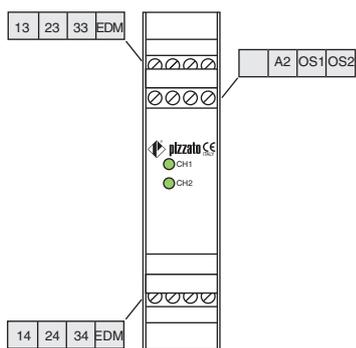

#### Function diagram

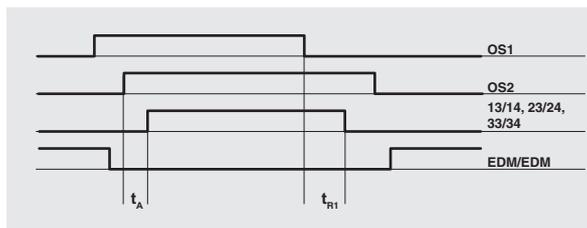

Legend:  
 $t_A$ : response time  
 $t_{R1}$ : release time

#### Internal block diagram

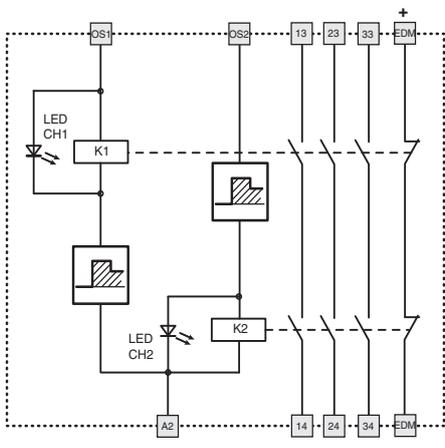

Application example on page 275.

#### Input configuration

OSSD semiconductor outputs (e.g. ST, NS, NG series or light barriers)

1 channel

2 channels

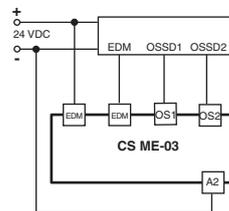
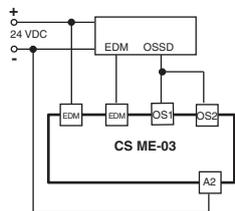

The diagram does not show the exact position of the terminals in the product

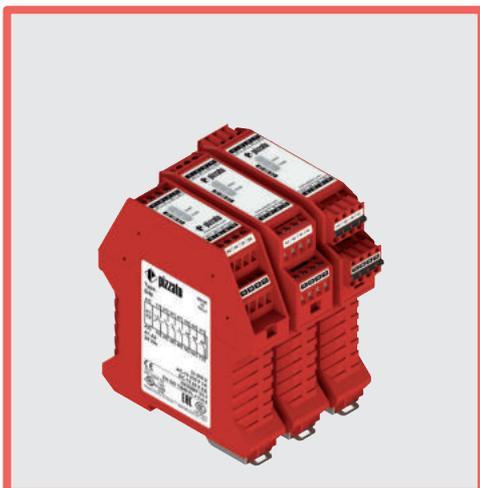

### Expansion module with delayed output contacts at de-energizing

#### Main features

- For safety applications up to SIL CL 3/PL e
- Possibility of control with one or two channels
- 4 delay times 0.5 - 1 - 2 and 3 s
- Reduced housing width of 22.5 mm
- Output contacts:
  - 4 NO safety contacts,
  - 2 NC auxiliary contacts,
  - 1 NC feedback contact
- Supply voltage: 24 Vdc

#### Utilization categories

Alternating current: AC15 (50...60 Hz)

U<sub>e</sub> (V) 230

I<sub>e</sub> (A) 3

Direct current: DC13 (6 oper. cycles/min.)

U<sub>e</sub> (V) 24

I<sub>e</sub> (A) 4

#### Quality marks:



EC type examination certificate: IMQ CP 432 DM

UL approval: E131787

CCC approval: 2013010305640211

EAC approval: RU C-IT.YT03.B.00035/19

#### Compliance with the requirements of:

Machinery Directive 2006/42/EC,

EMC Directive 2014/30/EC,

RoHS Directive 2011/65/EU.

### Technical data

#### Housing

Polyamide housing PA 66, self-extinguishing V0 acc. to UL 94

Protection degree acc. to EN 60529:

IP40 (housing), IP20 (terminal strip)

Dimensions:

see page 317, design A

#### General data

SIL level (SIL CL) up to:

SIL CL 3 acc. to EN 62061

Performance Level (PL) up to:

PL e acc. to EN ISO 13849-1

Safety category up to:

cat. 4 acc. to EN ISO 13849-1

(see base module category)

Safety parameters: see page 375

Ambient temperature: -25°C...+55°C

Mechanical endurance: >10 million operating cycles

Electrical endurance: >100,000 operating cycles

Pollution degree: external 3, internal 2

Rated impulse withstand voltage (U<sub>imp</sub>): 4 kV

Rated insulation voltage (U<sub>i</sub>): 250 V

Overtoltage category: II

#### Supply

Rated supply voltage (U<sub>n</sub>): 24 Vdc

Max. DC residual ripple in DC: 10%

Supply voltage tolerance: ±15% of U<sub>n</sub>

Power consumption DC: < 2 W

#### Control circuit

Maximum resistance per input: ≤ 50 Ω

Response time t<sub>A</sub>: < 120 ms

Release time in absence of power supply t<sub>R</sub>: see Code structure

#### In compliance with standards:

EN 60204-1, EN ISO 13855, EN 1037, EN ISO 12100, EN ISO 13850, EN 60529,

EN 61000-6-2, EN 61000-6-3, EN 61326-1, EN 60664-1, EN 60947-1, EN 50581,

EN ISO 13849-1, EN ISO 13849-2, EN 62061, UL 508, CSA C22.2 n° 14-95,

GB/T14048.5-2017

#### Output circuit

Output contacts: 4 NO safety contacts,  
2 NC auxiliary contacts,  
1 NC feedback contact

Contact type: forcibly guided

Material of the contacts: gold-plated silver alloy

Maximum switching voltage: 230/240 Vac; 300 Vdc

Max. current per contact: 6 A

Conventional free air thermal current I<sub>th</sub>: 6 A

Max. total current Σ I<sub>th</sub><sup>2</sup>: 64 A<sup>2</sup>

Minimum current: 10 mA

Contact resistance: ≤ 100 mΩ

External protection fuse: 4 A

### Code structure

article options  
**CS ME-20VU24-TF1**

#### Connection type

<b>V</b>	Screw terminals
<b>M</b>	Connector with screw terminals
<b>X</b>	Connector with spring terminals

#### Release time in absence of power supply (t<sub>R</sub>)

<b>TF0.5</b>	0.5 s fixed time
<b>TF1</b>	1 s fixed time
<b>TF2</b>	2 s fixed time
<b>TF3</b>	3 s fixed time

### Features approved by UL

Rated supply voltage (U <sub>n</sub> ):	24 Vdc
Power consumption DC:	< 2 W
Electrical ratings:	230/240 Vac 6 A general use C300 pilot duty

#### Notes:

- Use 60 or 75°C copper (Cu) conductor and wire size No. 30-12 AWG, stranded or solid.
- The terminal tightening torque of 5-7 lb in.
- Only for 24 Vac/dc versions: supply from remote Class 2 source or limited voltage limited energy.



### CS ME-20 expansion module

#### Pin assignment

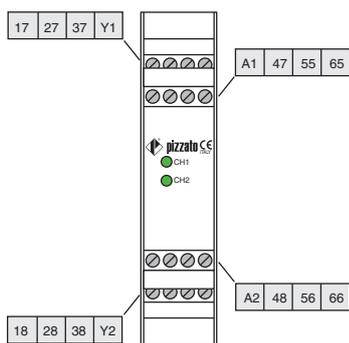

#### Function diagram

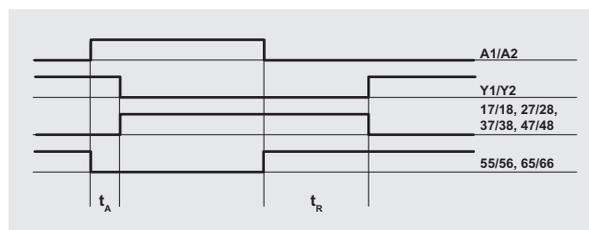

Legend:  
 $t_A$ : response time  
 $t_R$ : release time in absence of power supply (see "Code structure")

#### Internal block diagram

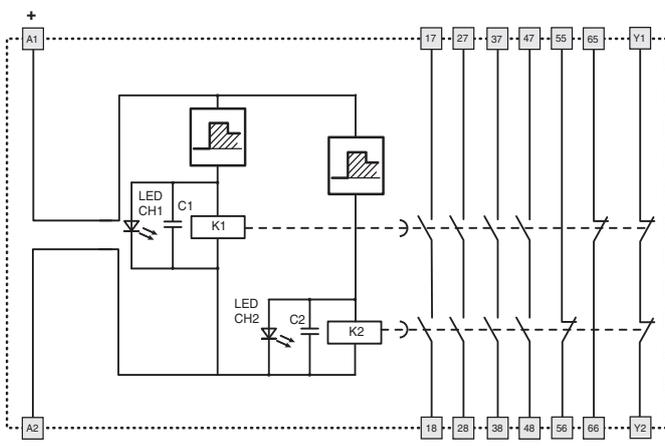

#### Input configuration

##### Single channel control

##### Double channel control

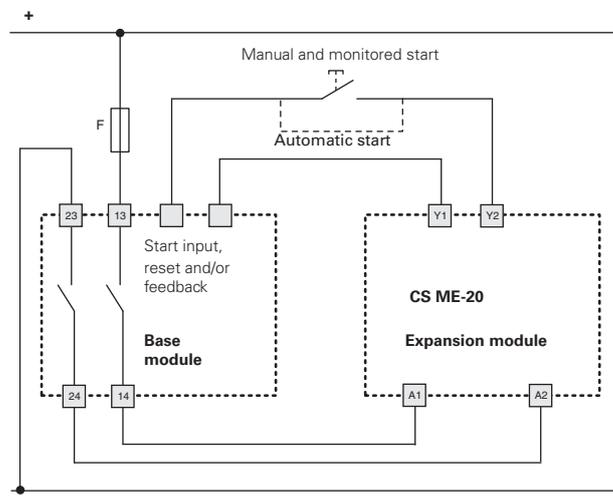
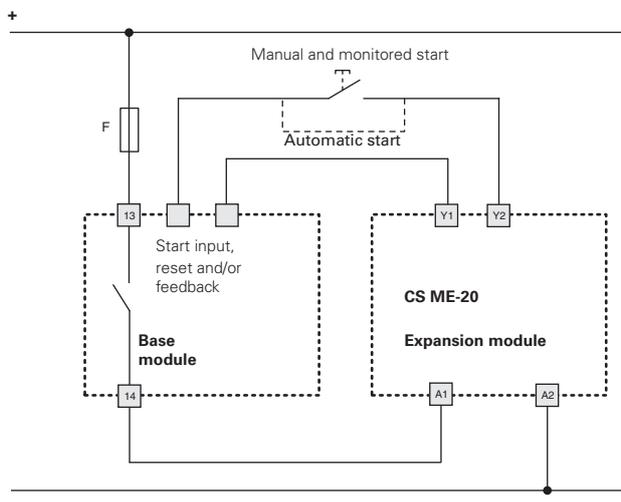

The diagram does not show the exact position of the terminals in the product



### Expansion module with delayed output contacts at de-energizing

#### Main features

- For safety applications up to SIL CL 3/PL e
- Possibility of control with one or two channels
- Fixed or adjustable delay times
- 45 mm housing
- Output contacts:
  - 4 NO safety contacts,
  - 2 NC auxiliary contacts,
  - 1 NC feedback contact
- Supply voltage: 24 Vdc

#### Utilization categories

Alternating current: AC15 (50...60 Hz)

U<sub>e</sub> (V) 230

I<sub>e</sub> (A) 3

Direct current: DC13 (6 oper. cycles/min.)

U<sub>e</sub> (V) 24

I<sub>e</sub> (A) 4

#### Quality marks:



EC type examination certificate: IMQ CP 432 DM

UL approval: E131787

CCC approval: 2013010305640211

EAC approval: RU C-IT.YT03.B.00035/19

#### Compliance with the requirements of:

Machinery Directive 2006/42/EC,

EMC Directive 2014/30/EC,

RoHS Directive 2011/65/EU.

### Technical data

#### Housing

Polyamide housing PA 66, self-extinguishing V0 acc. to UL 94

Protection degree acc. to EN 60529:

IP40 (housing), IP20 (terminal strip)

Dimensions:

see page 317, design C

#### General data

SIL level (SIL CL) up to:

SIL CL 3 acc. to EN 62061

Performance Level (PL) up to:

PL e acc. to EN ISO 13849-1

Safety category up to:

cat. 4 acc. to EN ISO 13849-1

(see base module category)

Safety parameters:

see page 375

Ambient temperature:

-25°C...+55°C

Mechanical endurance:

>10 million operating cycles

Electrical endurance:

>100,000 operating cycles

Pollution degree:

external 3, internal 2

Rated impulse withstand voltage (U<sub>imp</sub>):

4 kV

Rated insulation voltage (U):

250 V

Overvoltage category:

II

#### Supply

Rated supply voltage (U<sub>n</sub>):

24 Vdc

Max. DC residual ripple in DC:

10%

Supply voltage tolerance:

±15% of U<sub>n</sub>

Power consumption DC:

< 2 W

#### Control circuit

Maximum resistance per input:

≤ 50 Ω

Response time t<sub>A</sub>:

< 200 ms

Release time in absence of power supply t<sub>R</sub>:

see Code structure

#### In compliance with standards:

EN 60204-1, EN ISO 13855, EN 1037, EN ISO 12100, EN ISO 13850, EN 60529, EN 61000-6-2, EN 61000-6-3, EN 61326-1, EN 60664-1, EN 60947-1, EN 50581, EN ISO 13849-1, EN ISO 13849-2, EN 62061, UL 508, CSA C22.2 n° 14-95, GB/T14048.5-2017.

#### Output circuit

Output contacts:

4 NO safety contacts,  
2 NC auxiliary contacts,  
1 NC feedback contact

Contact type:

forcibly guided

Material of the contacts:

gold-plated silver alloy

Maximum switching voltage:

230/240 Vac; 300 Vdc

Max. current per contact:

6 A

Conventional free air thermal current I<sub>th</sub>:

6 A

Max. total current Σ I<sub>th</sub><sup>2</sup>:

64 A<sup>2</sup>

Minimum current:

10 mA

Contact resistance:

≤ 100 mΩ

External protection fuse:

4 A

### Code structure

article options  
**CS ME-30VU24-TF1**

#### Fixed or adjustable time

**0** fixed time

**1** adjustable time

#### Connection type

**V** Screw terminals

**M** Connector with screw terminals

**X** Connector with spring terminals

#### Release time in absence of power supply (t<sub>R</sub>)

**TF1** 1 s fixed time (CS ME-30 only)

...

**TF12** 12 s fixed time (CS ME-30 only)

**TS12** Time adjustable from 1 to 12 s in increments of 1 s (CS ME-31 only)

### Features approved by UL

Rated supply voltage (U<sub>n</sub>): 24 Vdc

Power consumption DC: < 2 W

Electrical ratings: 230/240 Vac

6 A general use

C300 pilot duty

#### Notes:

- Use 60 or 75°C copper (Cu) conductor and wire size No. 30-12 AWG, stranded or solid.

- The terminal tightening torque of 5-7 lb in.

- Only for 24 Vac/dc versions: supply from remote Class 2 source or limited voltage limited energy.





### CS ME-30 / CS ME-31 expansion module

#### Pin assignment

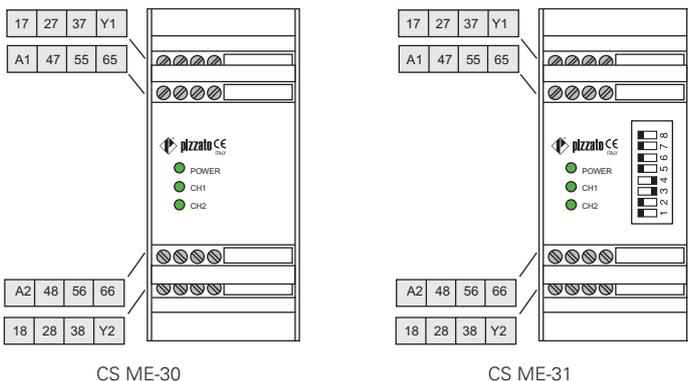

#### Function diagram

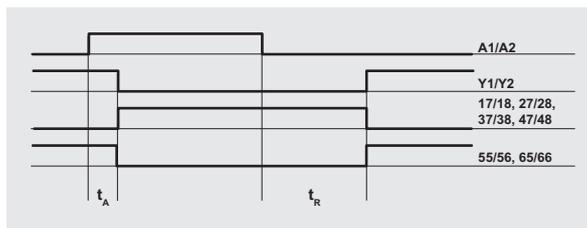

Legend:  
 $t_A$ : response time  
 $t_R$ : release time in absence of power supply (see "Code structure")

#### Internal block diagram

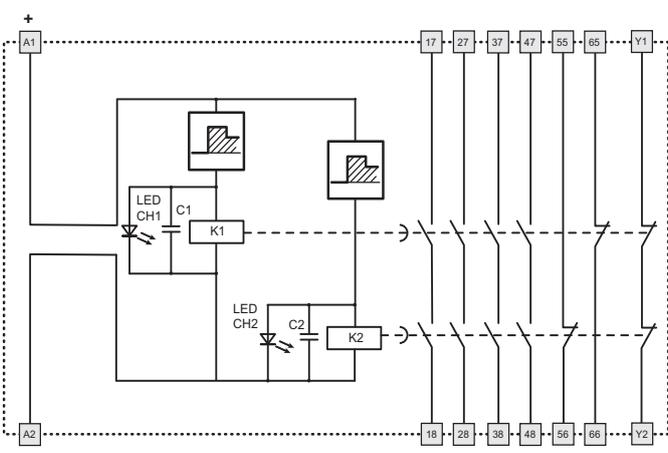

#### Release time selection $t_R$ (CS ME-31 only)

DIP SWITCH		$t_R$ (s)
ON	OFF	1
ON	OFF	2
ON	OFF	3
ON	OFF	4
ON	OFF	5
ON	OFF	6
ON	OFF	7
ON	OFF	8
ON	OFF	9
ON	OFF	10
ON	OFF	11
ON	OFF	12

#### Input configuration

##### Single channel control

##### Double channel control

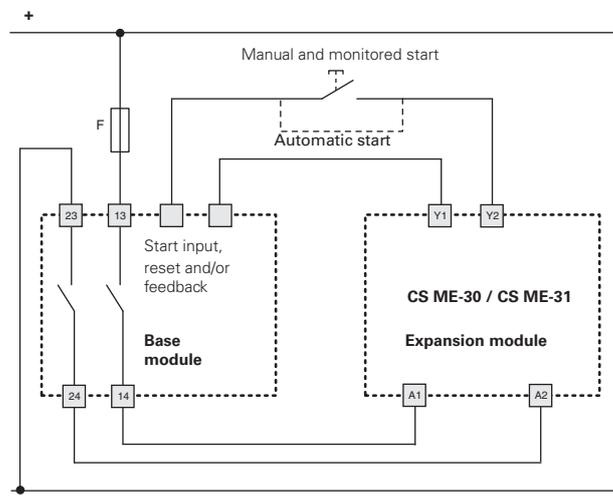
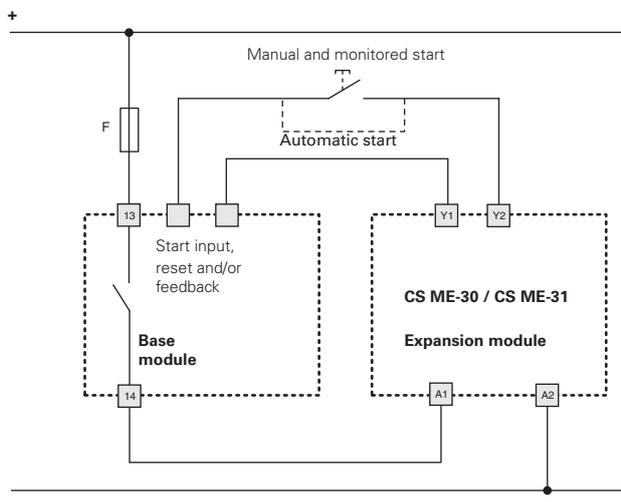

The diagram does not show the exact position of the terminals in the product

## External contactors for increasing the number and the load capacity of the contacts

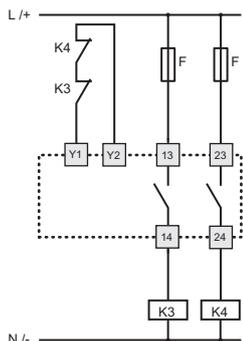

If necessary the number and the load capacity of output contacts can be increased by using expansion modules or contactors with forcibly guided contacts. For control of the external contactors, a NC contact of each relay is connected to the safety module feedback circuit between the start button terminals.

The following installation examples make use of the CS AR-08 module. For the use of other modules, see features, compatibility and internal block diagram of each single module.

## Application examples: monitoring of movable guards, up to category 4 according to EN ISO 13849-1

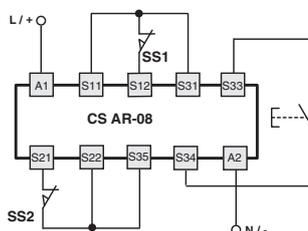
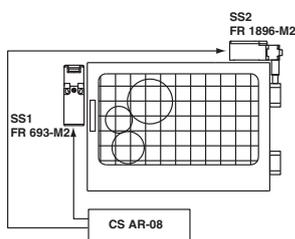

- Compatible modules**
- CS AR-01•••• CS AR-02••••
  - CS AR-04•••• CS AR-05••••
  - CS AR-06•••• CS AR-07••••
  - CS AR-08•••• CS AT-0••••
  - CS AT-1•••• CS AT-3••••
  - CS AR-91•024

Monitoring of one movable guard through two switches with different technology. System in safety category 4.

## Application examples: monitoring of safety magnetic sensors, up to category 4 according to EN ISO 13849-1

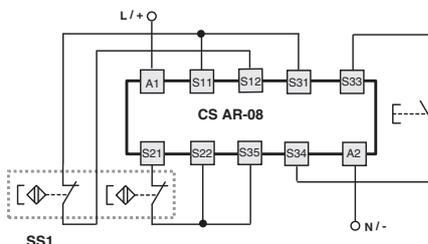
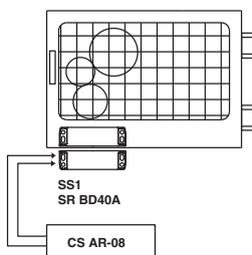

- Compatible modules**
- CS AR-01•E02 CS AR-02•E02
  - CS AR-04•024 CS AR-05••••
  - CS AR-06•••• CS AR-08••••
  - CS AT-0•••• CS AT-1••••
  - CS AT-3•••• CS AR-91•024

Monitoring of one movable guard through one coded magnetic sensor. System in safety category 4.

## Application examples: light barrier monitoring, up to category 4 according to EN ISO 13849-1

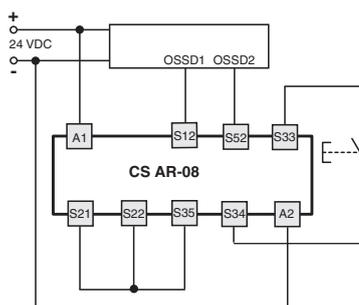
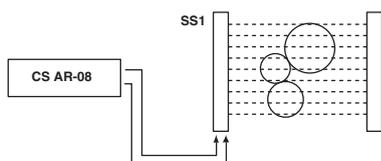

- Compatible modules**
- CS AR-05•••• CS AR-06••••
  - CS AR-08•••• CS AT-0••••
  - CS AT-1••••

Semiconductor outputs (e.g. light barriers) with two OSSD outputs. System in safety category 2 or 4 according to the barrier.



**Application examples: monitoring of a switch and a button for emergency stop, up to cat. 3 according to EN ISO 13849-1**

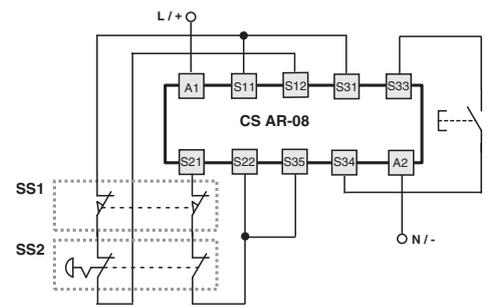
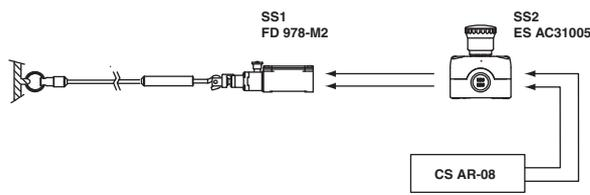

- Compatible modules**
- CS AR-01•••• CS AR-02•••• CS AR-04•••• CS AR-05••••
  - CS AR-06•••• CS AR-07•••• CS AR-08•••• CS AR-20••••
  - CS AR-21•••• CS AR-22•••• CS AR-23•••• CS AR-24••••
  - CS AR-25•••• CS AT-0•••• CS AT-1•••• CS AT-3••••
  - CS AR-91•024

**Application examples: monitoring of a series of switches and magnetic sensors, up to cat. 3 according to EN ISO 13849-1**

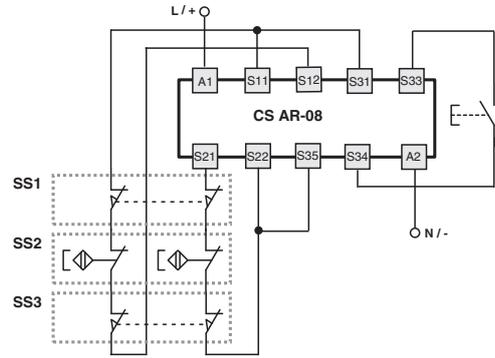
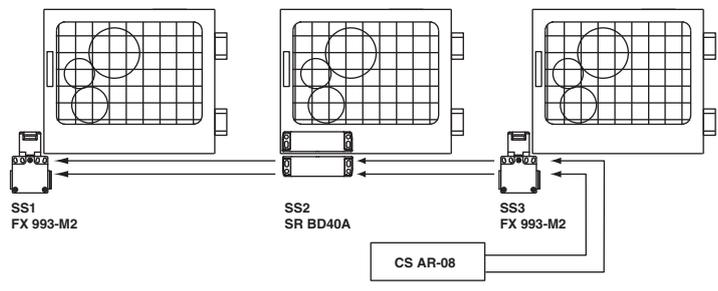

- Compatible modules**
- CS AR-01•E02 CS AR-02•E02 CS AR-04•024 CS AR-05••••
  - CS AR-06•••• CS AR-08•••• CS AT-0•••• CS AT-1••••
  - CS AT-3•••• CS AR-91•024

Monitoring of several guards through switches and magnetic sensors. System in category 3. For the calculation of the diagnostic coverage, see ISO TR24119.

- The use of just one switch per guard requires that it be possible to exclude the possibility of mechanical breakage of the switch during the risk assessment.
- The sensor must have two channels and be coded.
- If available, verify the provisions of the Type C standard for your own machine.

**Application examples: possibility of parallel module reset, up to category 4 according to EN ISO 13849-1**

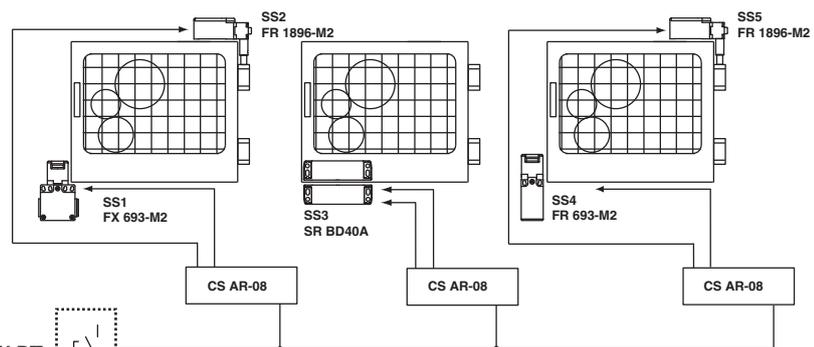

Monitoring of several guards through different technologies. System in safety category 4. The example shows the possibility of a contemporaneous reset of several modules via a single contact of a button.

- Compatible modules**
- CS AR-04•024 CS AR-05•024 CS AR-06•024
  - CS AR-08•024 CS AR-91•024

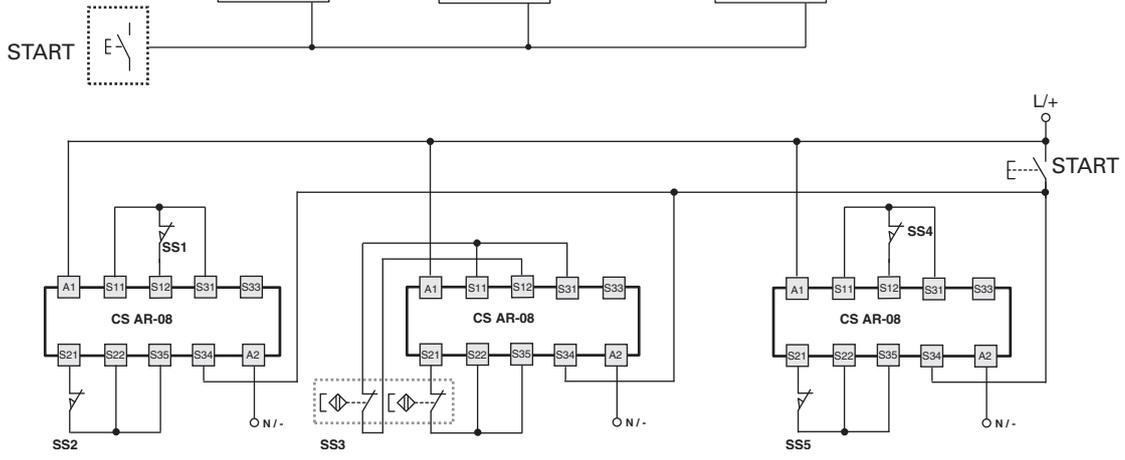

**Movable guard monitoring in category 4 up to PL e acc. to EN ISO 13849-1  
Guard interlock in category 2 up to PL d acc. to EN ISO 13849-1**

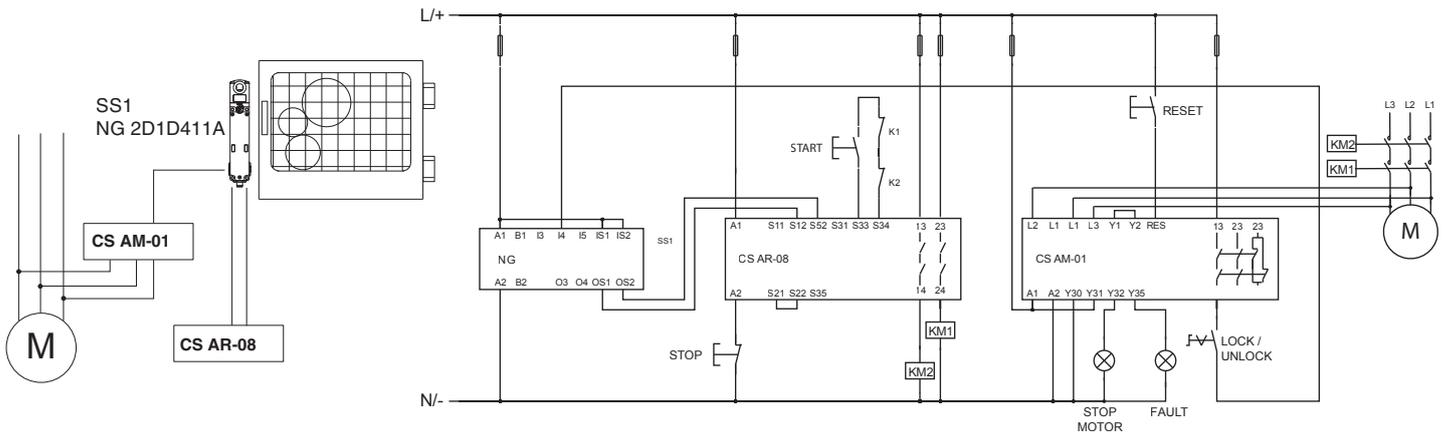

Guard monitoring and interlock by means of interlocking device with RFID technology in category 4, PL e and SIL3. Release command enabled by the safety module for standstill monitoring.

**Movable guard monitoring in category 4 up to PL e acc. to EN ISO 13849-1  
Guard interlock in category 2 up to PL d acc. to EN ISO 13849-1**

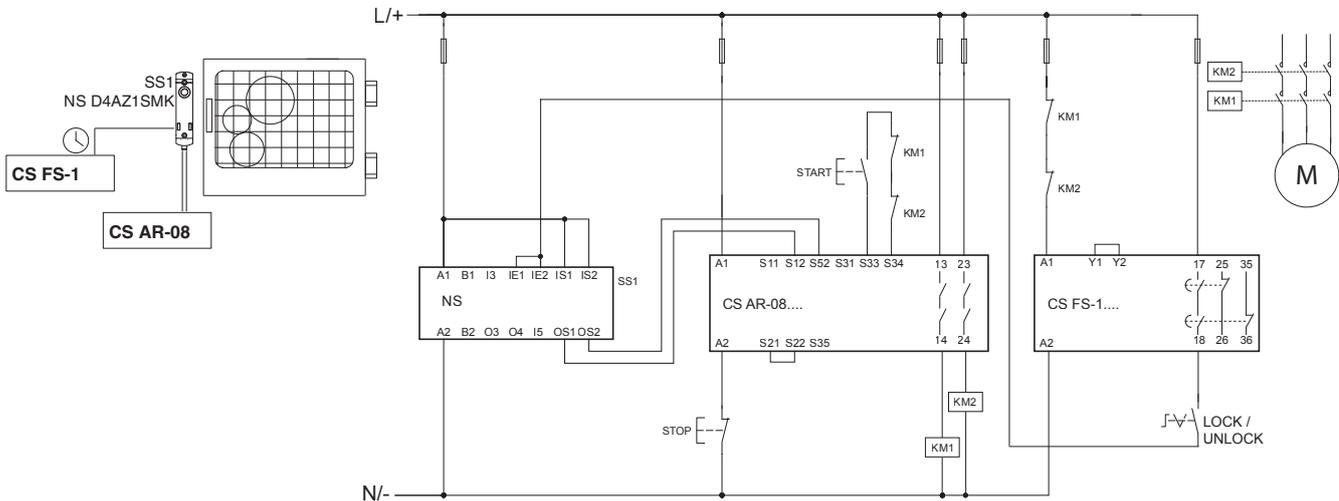

Guard monitoring and interlock by means of interlocking device with RFID technology in category 4, PL e and SIL3. Release command enabled by the safety timer.

**Connection of two expansion modules to the PNP safety outputs of a programmable module of the GEMNIS series**

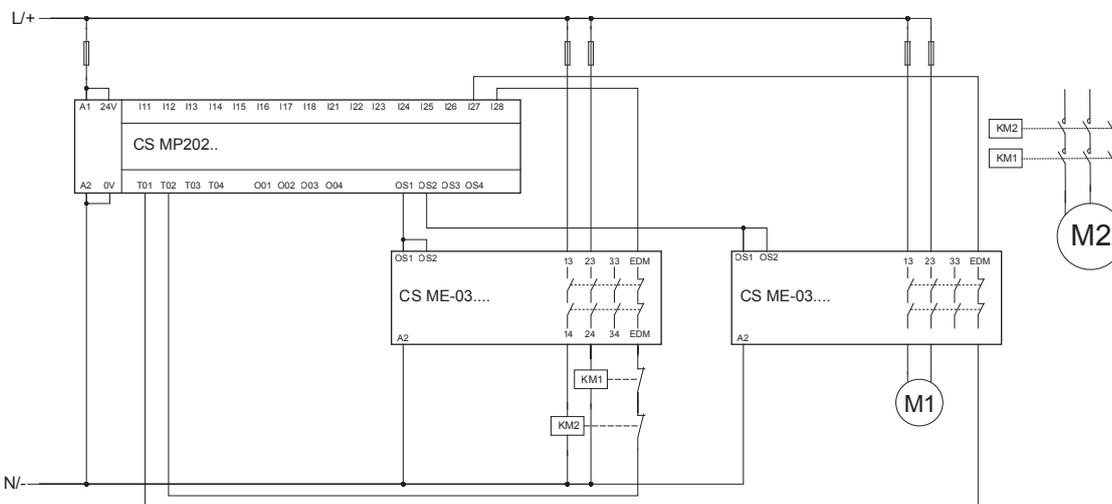

The circuit diagram only shows the connection of the expansion modules; the connection of inputs and other outputs was intentionally omitted.

Note: Motor M1 with load according to the utilisation categories of the contacts of the CS ME-03 module.

Note: The connection between OS1 of module CS MP-202 and inputs OS1 and OS2 of module CS ME-03 can be regarded as fault-excluded since both are located in the same housing. See table D.4, item D.5.2 of EN ISO 13849-2.

NOTE: The NC contacts of KM1 and KM2 are mechanically guided (EN 60947-4-1, Annex F)



### Monitoring of guards by means of sensors with RFID technology in series connection

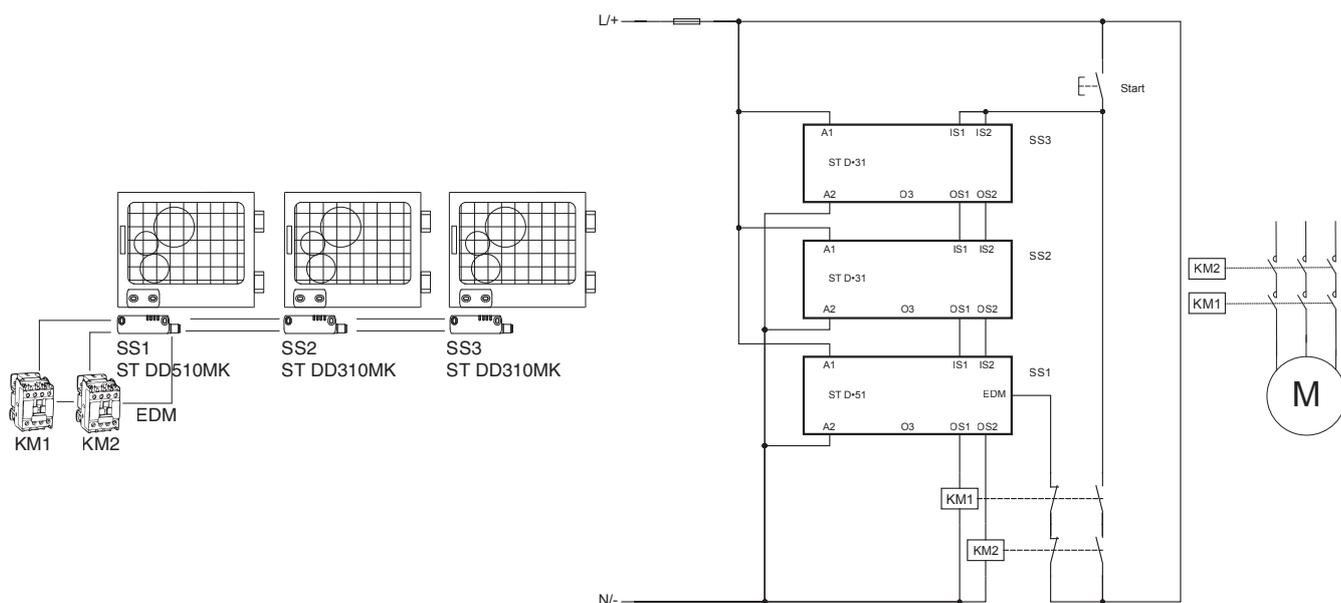

Direct monitoring of the status of the contactors via the EDM input of the last sensor in the series connection

### Category IIIC two-hand control acc. to EN574

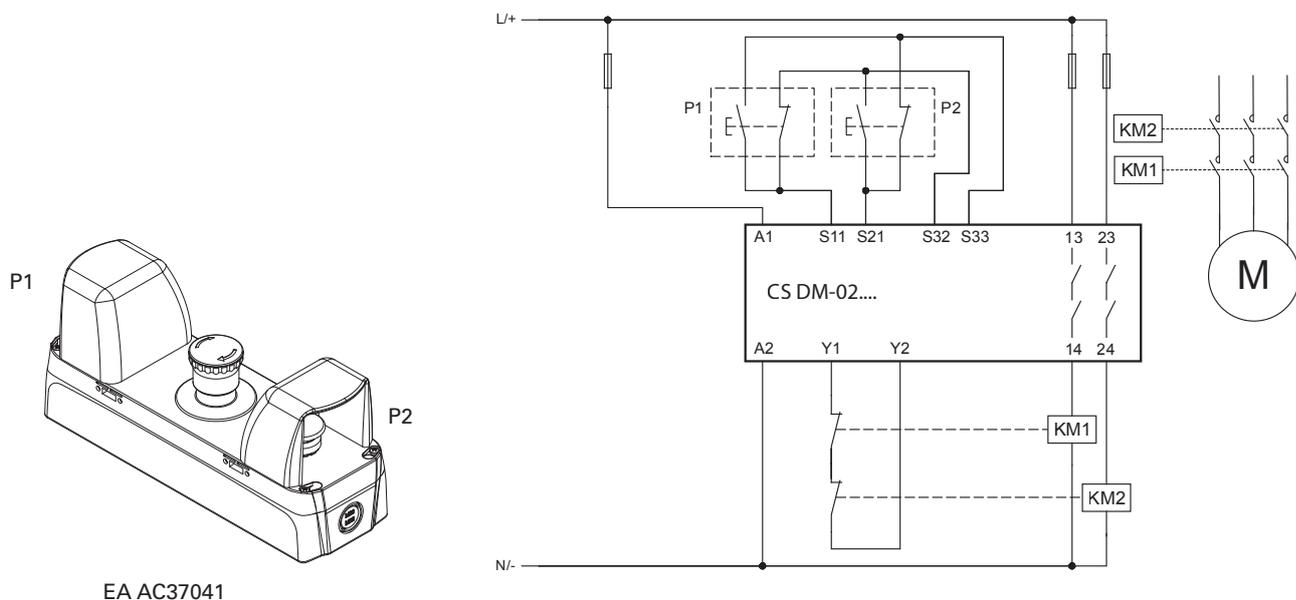

## Introduction



# GEMNIS

A Gemnis series module is a programmable safety device, which allows several safety functions to be carried out simultaneously. This product series has been developed specifically to meet the needs of machinery manufacturers for machines with a low to average number of safety functions. As an indication, these modules can manage small applications which are equivalent to the functions carried out by 3 to 4 traditional electromechanical safety modules, up to circuits with dozens of inputs.

Gemnis series safety modules can implement safety circuits with a safety category of up to SIL 3 acc. to EN 62061, PL e and category 4 acc. to EN ISO 13849-1.

The Gemnis series of safety modules has been updated to **version 11.7** which introduces new functions and improved hardware- and software-level performance. This update considerably increases the application potential of these products.

The **Gemnis Studio** program is a graphic development environment for the creation, simulation and debugging of programs that are uploaded to the corresponding modules of the Gemnis family.

This software is licensed to users wishing to program these modules, subject to prior registration at [www.gemnis.com](http://www.gemnis.com).

You can download the new **Gemnis Studio** software version (**Gemnis Studio 11.7**) from the site, which will allow you to program both current, **Gemnis K11**-designated modules, as well as previous ones.

## General features of safety modules

Gemnis series modules can manage all of the following safety device types.

- Mechanical safety switches
- Switches with solenoid for guard interlock
- Magnetic safety sensors
- Safety light barriers or optical safety sensors (category 4)
- Safety sensors
- Mushroom buttons for emergency stop
- Rope switches for emergency stop
- Safety mats or safety bumpers with 4-wire technology
- Category IIIA or IIIC two-hand controls
- Safety selector switches
- Enabling devices
- Analogue sensors 4-20 mA (Gemnis Studio 11)
- 0-4 kHz frequency signals (Gemnis Studio 11)
- Dual-beam muting systems (Gemnis Studio 11).

This modules are also equipped with functionality allowing you to also implement:

- safety timers;
- detection of various types of faults in safety devices or their connections;
- verification of the module's internal temperature limit values;
- status communication via USB port.

Finally, Gemnis series modules can:

- manage up to eight different electronic safety outputs or four relay outputs;
- manage various signalling outputs (not safety-related);
- status information and data settings via the USB communication port.

Gemnis design safety modules can implement safety circuits with up to SIL CL3 acc. to EN ISO 62061, PL e and category 4 acc. to EN ISO 13849-1.



## Website

This product line is supported online via the [www.gemnis.com](http://www.gemnis.com) website, where you can:

- download the Gemnis Studio installation package (following registration);
- download support files;
- get the most up to date version of the instruction manual;
- get examples and other support information which will be added over time;
- watch videos illustrating Gemnis Studio program operation.

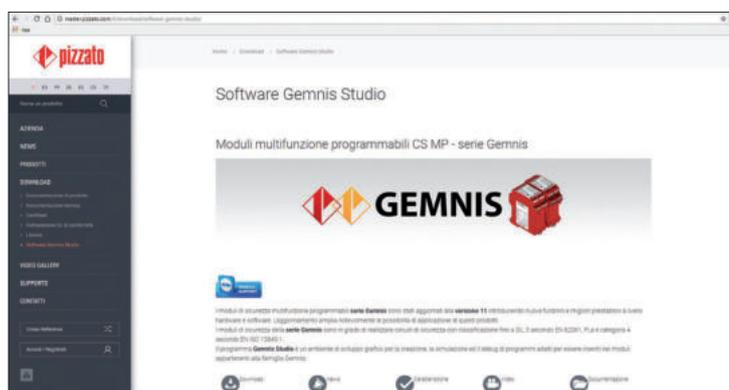
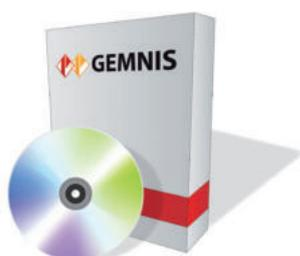



## Hardware structure of the modules

Gemnis design modules are created with increased flexibility - even at the hardware level. These products are made up of various electronic circuit boards which are sold in various combinations, but which are always contained in a single housing and with one unique product code.

The Gemnis series modules have a general redundant and self monitoring type structure, they are controlled by a pair of processors which simultaneously run the application program and constantly monitor their operation and system integrity in parallel.

Each module is supplied in a single housing, of the minimum width required to house the boards which make up the module. 45 mm to 90 mm wide housings are available. The customer does not need to worry therefore about wiring the various parts.



The USB port integrated within the module is used for programming and debugging of the Gemnis Studio software module. Once a module is programmed, you can also use the USB port for communicating with a PC installed on the machine, and for the exchange of information relating to the module state.

The main hardware innovations introduced to version 11 by the safety module update are the following:

- ability to manage programs up to 4 times larger;
- the ability, with new dedicated modules, to manage analogue and/or speed inputs;
- models with 8 electronic safety outputs;
- new module configurations available (see following table).

Module	Inputs type I	Inputs type J	Inputs type C	Inputs type F	Test signals T	OS safety outputs	O signalling outputs	Port	Width (mm)	Page
CS MP201M0	8	-	-	-	8	3NO	4	USB	45	283
CS MP202M0	16	-	-	-	4	4 PNP	4	USB	45	284
CS MP203M0	12	-	-	-	4	3NO + 1NO	4	USB	45	285
CS MP204M0	12	-	-	-	4	3NO	4	USB	45	286
CS MP205M0	4	4	-	4	4	4 PNP	4	USB	45	287
CS MP206M0	8	-	-	-	4	4 PNP	12	USB	45	288
CS MP207M0	4	-	2	-	4	4 PNP	4	USB	45	289
CS MP208M0	16	-	-	-	4	8 PNP	-	USB	45	290
CS MP301M0	24	-	-	-	8	3NO	4	USB	67.5	291
CS MP302M0	24	-	-	-	12	4 PNP	4	USB	67.5	292
CS MP303M0	32	-	-	-	4	4 PNP	4	USB	67.5	293
CS MP304M0	28	-	-	-	4	3NO + 1NO	4	USB	67.5	294
CS MP305M0	24	-	-	-	4	4 PNP	12	USB	67.5	295
CS MP306M0	20	-	-	-	4	3NO + 1NO	12	USB	67.5	296
CS MP307M0	8	4	2	4	4	4 PNP	4	USB	67.5	297
CS MP308M0	24	-	-	-	4	8 PNP	8	USB	67.5	298
CS MP309M0	32	-	-	-	4	8 PNP	-	USB	67.5	299
CS MP401M0	40	-	-	-	4	4 PNP	12	USB	90	300
CS MP402M0	32	-	-	-	12	8 PNP	8	USB	90	301
CS MP403M0	40	-	-	-	4	8 PNP	8	USB	90	302

I = Digital inputs

J = Digital inputs, decoupled

C = Inputs for 4-20 mA analogue signals

F = Inputs for 0 ... 4 kHz frequency signals

T = Test signals

OS = OSSD safety outputs (PNP)

nn = Relay safety outputs

O = signalling outputs (PNP)

## Software Gemnis Studio

Gemis Studio is software designed to allow the user to program a module belonging to the Gemnis line. This software has a graphical interface to visually display, in a natural and intuitive way, the assembly of operations that the application program will execute, once loaded to the module. Gemnis Studio allows you to attach supporting information and useful notes to the configuration information, for overall understanding of the program. Gemnis Studio also allows you to check correct application program operation prior to sending it to the module via the simulation.

Finally, Gemnis Studio allows you to carry out monitoring and detection operations, and to graphically represent the state of an active operational device in real time.

## New release 11.7 available

In the latest version of Gemnis Studio 11.7.1.0 the following new features have been introduced:

- "SERIAL" function block for communication with PLC;
- program migration tool;
- new settings available in the "MUTING" and "EDM" function blocks;
- new parameters available in the "Display" object;
- new graphic features (colouring of the terminals of the function blocks according to the connection; option of setting the "minimal" display of the connections; updated images of the safety devices and sensors available in the library);
- possibility to export in PDF format the printouts of the program and of the report.



## Desktop

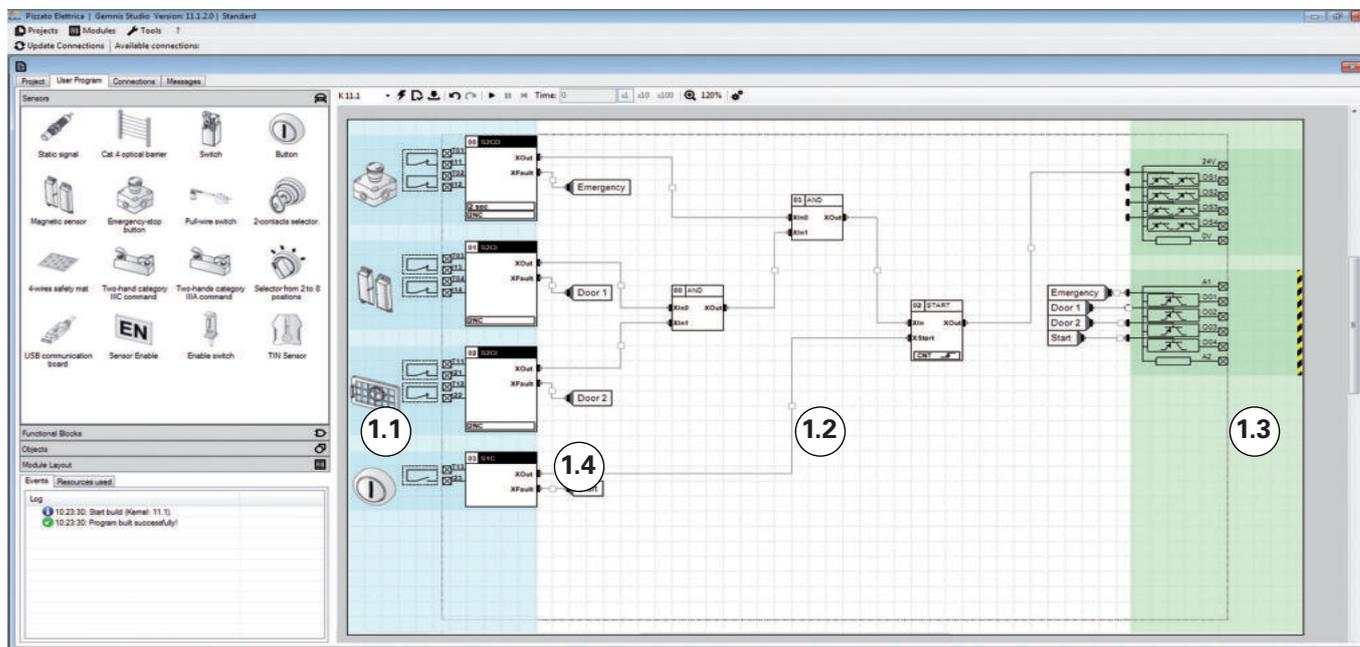

The Gemnis Studio software has been designed with the objective of making Gemnis series module operation as immediate and visual as possible. With this aim, we decided to create a work environment – the Desktop – where, as far as possible, the user can amass all the information required to actually "view" and not just "imagine" the behaviour of the project under development. This is the reason we have made room for graphical object representations, of the physical characteristics of the module in use, and immediate interaction, by means of simulation, with the created program.

The desktop is the main user work area, the zone where the flow and processing to be applied to the data detected by the module are defined using the graphical program interface.

The desktop is divided into three parts:

- 1.1) the sensor zone
- 1.2) the functional block zone
- 1.3) the output zone

In the sensor zone (1.1) the user indicates the external device types connected to the module terminals, and all the parameters needed to define them.

In the output zone (1.3) all the output devices present in the selected module (relays, transistors etc.) are immediately shown.

In the function block zone (1.2) the user will enter all the logical functions needed to process the flow of data coming from the sensors, and will proceed to make the connections to transfer this data between the objects in the desktop and finally to the outputs.

The desktop includes a dotted box (1.4) which represents the area "occupied by the module", or, everything enclosed within the physical module, from terminals to code. The area outside this box, meanwhile, is occupied by images of the physical devices external to the module (switches, buttons, etc.), illustrating their expected internal structure and any description.

At the user's request, the desktop content is compiled and, provided there are no errors, it is translated into the application program. If a module is connected to the computer, you can immediately transfer the application program to it, and thereby check its effective operation in the field.

Otherwise it is possible to simulate application program operation directly on the desktop, by interacting with the sensors and evaluating their effects graphically.

## Project

The collection of information required to configure a module and describe its activities is called a "Project". Using Gemnis Studio, the user can assemble the textual and graphical information required to elaborate and comment the functions which will be carried out by the program, once installed on a Gemnis line module.

## Printing

Gemis Studio can generate a Connection Report, which includes all connections to the module terminals, and a user Program Report, allowing you to print the Application Program.

## Password

The password gives the option of protecting a module's interaction capacity, and the ability to modify the project file.





### Sensors

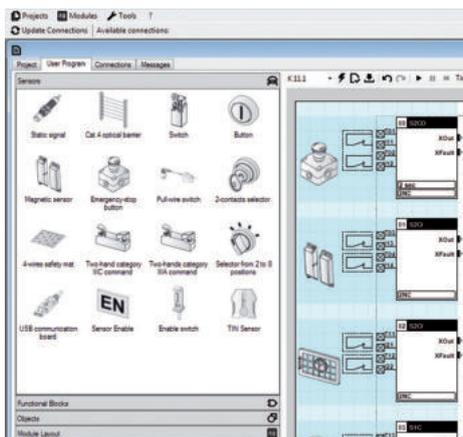

The sensor zone indicates the external device types which can be connected to the module terminals, and all the parameters needed to define them.

Each sensor created displays a view of the internal contact configuration and of how the contacts are connected to the module terminals, a box with the associated safety function, and the parameters selected for the function.

From the sensor panel, you can select a sensor using the mouse and drag it into the dedicated desktop area.

A full list of the available sensors is shown on the side.

### Sensor list

Sensor type	Diagram	Examples
Sensor with 1 not testable channel		
Sensor with 2 not testable channels, with interdependent signals		
Sensor with 1 tested channel		
Sensor with 2 independent tested channels		
Sensor with 2 dependent tested channels		
Sensor with 2 always-closed tested channels, short circuit permitted between the channels		
Sensor with 2 tested channels which can be crossed		
Sensor with 2 tested channels which cannot be crossed		
Sensor with 2 to 8 tested channels which cannot be crossed and which may only be active one at a time		
Sensor with 2 tested channels which cannot be crossed and which must follow a very precise activation/deactivation sequence made up of three states: rest, work, stop		
Dual temperature sensor integrated in module		
Monitoring of a pair of analogue sensors with 4-20 mA output in both 2-wire and 3-wire versions		
Monitoring of a pair of signals with frequencies up to 4 KHz		

### Function blocks

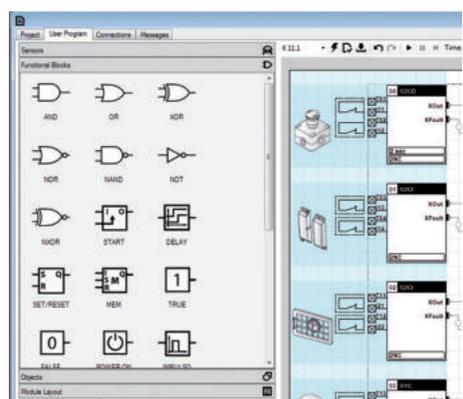

The function blocks represent all the logic functions required to process the data flow between sensors and outputs.

From the function block panel, a block can be selected using the mouse and dragged into the dedicated desktop area.

A full list of the available function blocks is shown on the side.

### List of available pizzato blocks

	AND Basic Boolean function		POWER ON Active signal at first execution cycle		FILTER Filters a signal from interference for a duration lower than set time
	OR Basic Boolean function		PULSE Returns a signal of type Delay Off on the preselected input edge		LDC Upstream function block for monitoring of a door-locking system
	XOR Basic Boolean function		CLOCK Generates pulses at pre-established fixed intervals		WAVE Generates a waveform with variable period and ON time
	NOR Basic Boolean function		ERROR Puts the module into Error State		MUTE2 Upstream function block for monitoring of a 2-beam muting system
	NAND Basic Boolean function		LKTBL Conversion table between data of the same type		SERIAL Allows a telegram with a length of up to 32 bits to be transmitted to any output of the module.
	NOT Basic Boolean function		GEQ/EQU/LEQ Carries out a numerical comparison between two values of type B or W and displays the result in boolean format (X)		
	NXOR Basic Boolean function		MESSAGE Transmits a message on the USB and COM ports		
	START Control function		COUNTER Pulse counter		
	DELAY Returns a signal of type Delay Off or Delay On		TRIGGER Detects the edge, either rising or falling, of an input signal		
	SET/RESET Basic logical memory function				
	TRUE / FALSE Basic Boolean function				

## Simulation

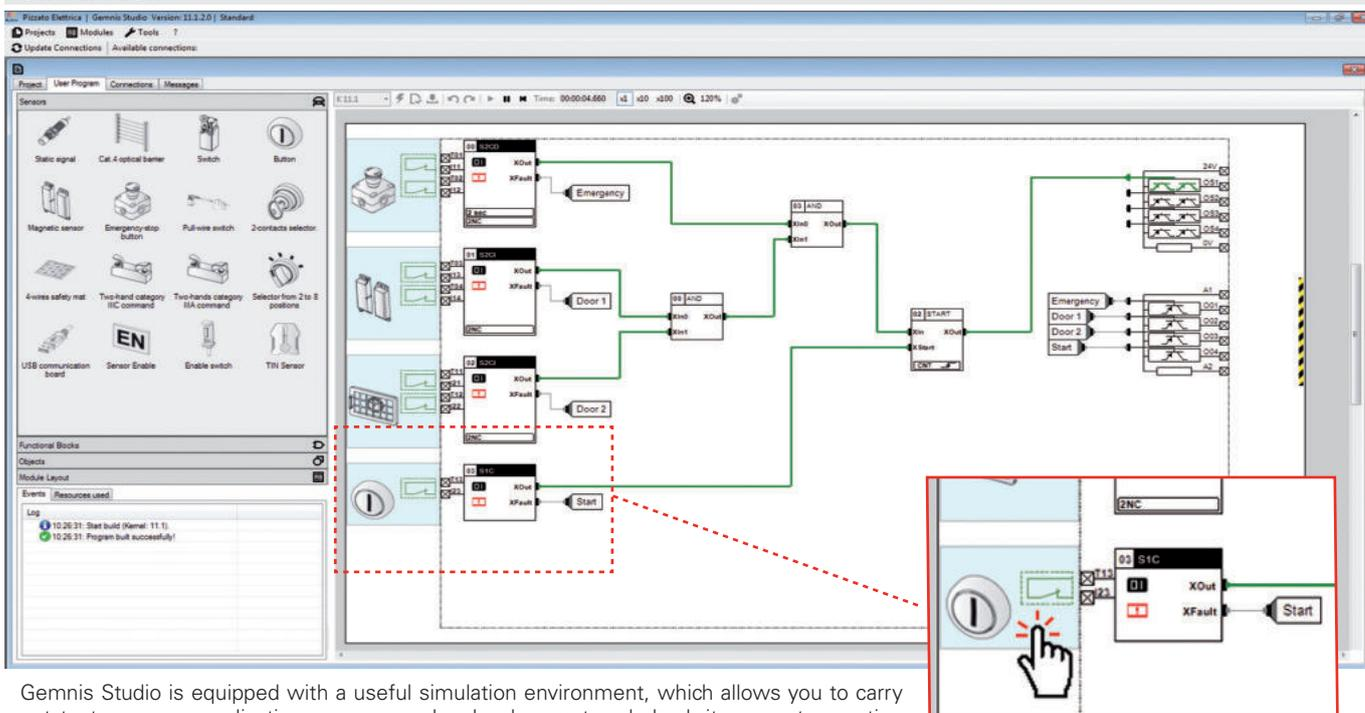

Gemis Studio is equipped with a useful simulation environment, which allows you to carry out tests on your application program under development and check its correct operation before you install it in a module. To run an application program simulation during the development phase, simply press the Start button on the toolbar at the top of the desktop. If the application program cannot be compiled, the simulation will not run.

Upon start of the simulation phase, the desktop and the way you interact with it change. During this phase you can simulate module operation by interacting with the sensors and simulating real world conditions or operations. Clicking on the sensors will make them execute, in sequence, the standard events for each sensor. Each of these interactions modifies the state of the sensor output variables which, via the connectors, will become the input variables of the function blocks, which will evaluate them and so on, until the data arrives at the outputs that will or will not activate. This simulates exactly what will happen in the module.

Transmission of the information via the connectors is visible via colour change of the connectors.

## Monitor

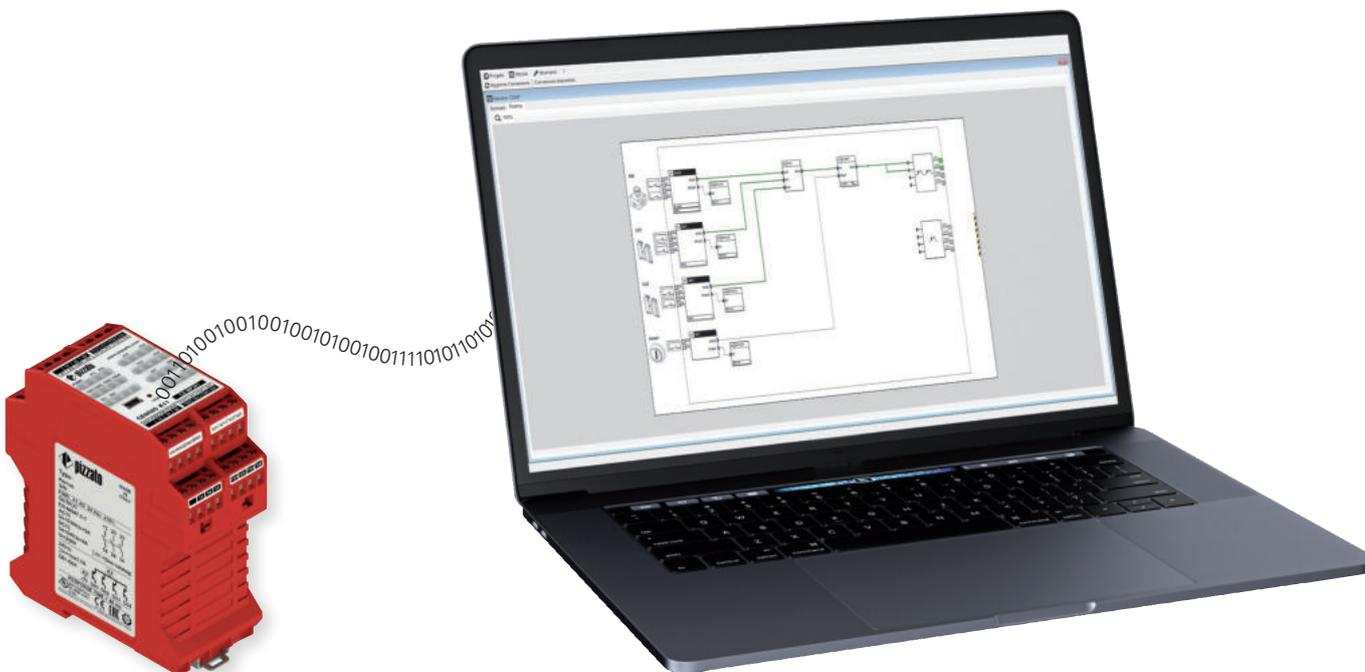

You can monitor operation of one or more Gemnis modules in real time using the Monitor function.

You can observe the overall operation state of the module and various data relating to the program being executed, including a list of most recently saved programs. The execution status of the program as well as the status of the module inputs and outputs can be viewed in real time. In Gemnis Studio 11 the video data update has been made faster and graphical pan & zoom functions are also available for the analysis of large projects.

## New SERIAL function block

The **SERIAL function block** was introduced with the **11.7.1.0** release of **GEMNIS STUDIO**, allowing a telegram with a length of up to 32 bits to be transmitted to any output of the module.

With the SERIAL function block it is therefore possible to export "bit" type information from a Gemnis safety module (typically the open or closed state of the guard, but also the locked or unlocked state of the guard, or results of logical combinations between other GEMNIS STUDIO function blocks) using a maximum of 2 cables and 2 module outputs.

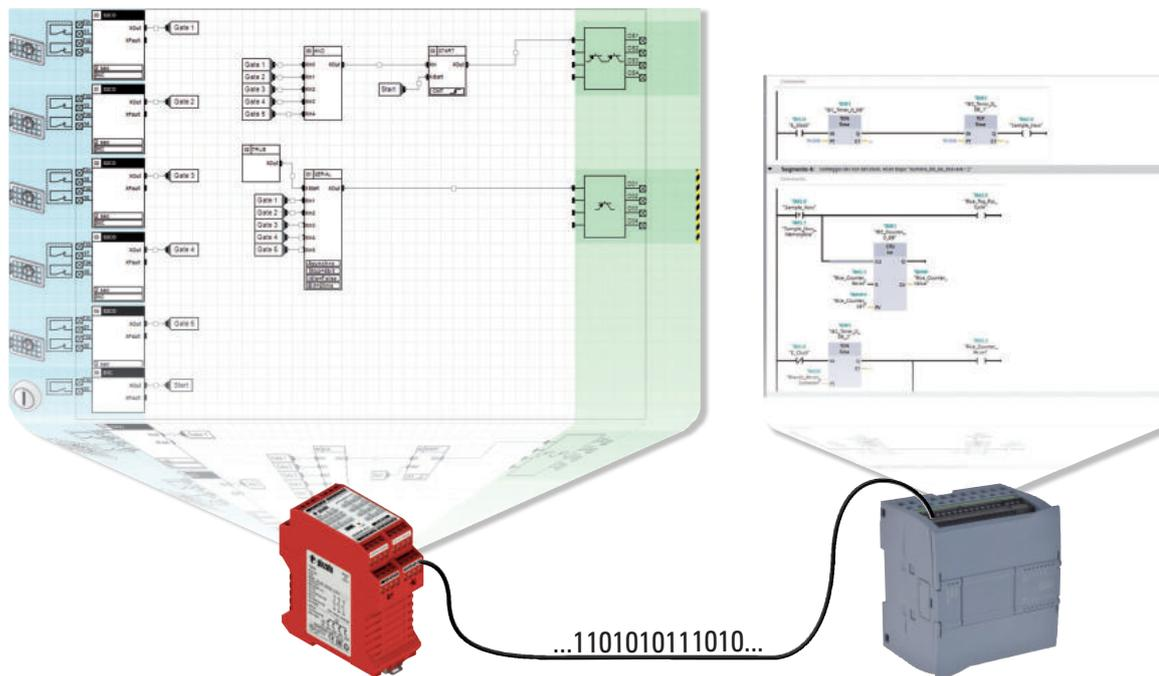

### Transmission parameters

The function block allows a wide range of transmission parameters to be set:

- number of bits to be transmitted (2 to 32): any digital signal, including function block outputs;
- 2 types of transmission: synchronous (uses two outputs: signal and clock) or asynchronous (one self-synchronizing output, bit with Manchester coding);
- adjustable bit duration from 10 to 500 ms;
- IDLE status of the output cable (0, 1);
- number of fill bits between two consecutive transmissions (2 to 10);
- max. transmission speed: 100 bit/s in synchronous transmission, 50 bit/s in asynchronous transmission.

### Advantages for the user

- The new SERIAL function block can be used on all Gemnis modules, even on previously purchased ones.
- **No hardware upgrade costs.**
- Simply download the **new release of Gemnis Studio 11.7.1.0**
- Less outputs occupied in the module: 1 single output for transmitting up to 32 bits.
- Less wiring: only 1 or 2 wires are required.
- No need for a PC with USB connection to the safety module.
- The pulse sequence can be decoded with any type of PLC.

### Technical support

Pizzato Elettrica provides technical support free of charge to users who have registered on the website and downloaded Gemnis Studio.

The information requested must be relevant to the functionality of the module. We do not provide a consulting service based on the customer's application.



### Online support

The site [www.gemnis.com](http://www.gemnis.com) contains video tutorials illustrating Gemnis Studio program operation.

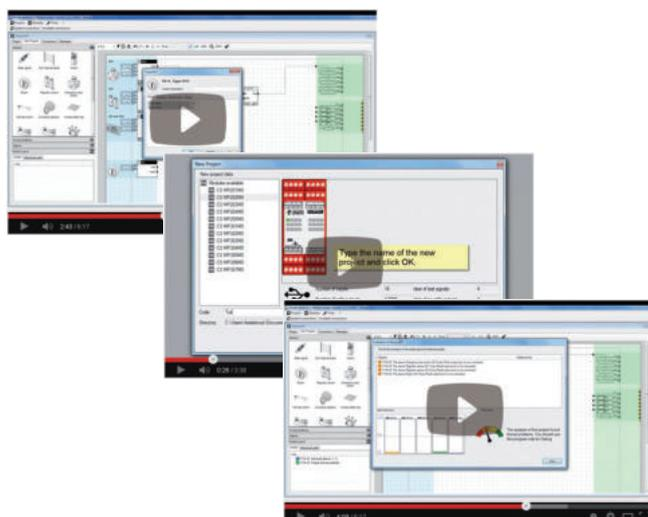



**Main features**

- For safety applications up to SIL CL 3/PL e
- Supply voltage: 24 Vdc
- Gemnis Studio for easy and intuitive programming and program simulation
- Large selection of logical blocks for the management of external devices and programs
- Custom configured versions available on request

**Quality marks:**



EC type examination certificate: M6A 16 06 75157 010  
 UL approval: E131787  
 CCC approval: 2013010305640211  
 TÜV SÜD approval: Z10 16 05 75157 009  
 EAC approval: RU C-IT.YT03.B.00035/19

**General data**

Parameter:	Value:	Page:
SIL CL acc. to EN IEC 62061	up to SIL CL 3	
Performance Level (PL) acc. to EN ISO 13849-1	up to PL e	
Safety category acc. to EN ISO 13849-1	up to cat. 4	
MTTF <sub>D</sub>	135	
PFH <sub>D</sub>	1.44E-09	
Mission time	20 years	
System response time	< 40 ms	
Dimensions (HxLxW)	111.5x45x99 mm	
Housing data		303 part 1
Environmental data		303 part 2
Supply		303 part 3
In compliance with standards		303 part 4
Programming software	Gemis Studio	303 part 5
USB port	Yes	
Safety inputs (Ix)	8	303 part 6
Test outputs (Tx)	8	303 part 10
Semiconductor signalling output circuits (Ox)	4	303 part 11
Safety relay circuits	3NO	303 part 14

**Pin assignment**

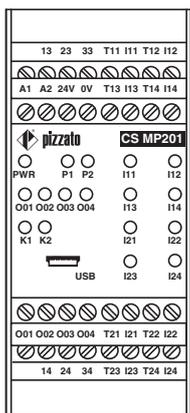

**Internal block diagram**

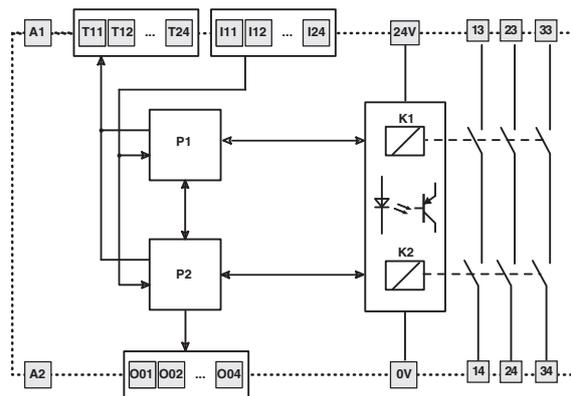

**Code structure**

**CS MP201M0**

**Connection type**

- M** Connector with screw terminals
- X** Connector with spring terminals



### Main features

- For safety applications up to SIL CL 3/PL e
- Supply voltage: 24 Vdc
- Gemnis Studio for easy and intuitive programming and program simulation
- Large selection of logical blocks for the management of external devices and programs
- Custom configured versions available on request

### General data

Parameter:	Value:	Page:
SIL CL acc. to EN IEC 62061	up to SIL CL 3	
Performance Level (PL) acc. to EN ISO 13849-1	up to PL e	
Safety category acc. to EN ISO 13849-1	up to cat. 4	
MTTF <sub>D</sub>	614	
PFH <sub>D</sub>	1.32E-09	
Mission time	20 years	
System response time	< 30 ms	
Dimensions (HxLxW)	111.5x45x99 mm	
Housing data		303 part 1
Environmental data		303 part 2
Supply		303 part 3
In compliance with standards		303 part 4
Programming software	Gemis Studio	303 part 5
USB port	Yes	
Safety inputs (Ix)	16	303 part 6
Test outputs (Tx)	4	303 part 10
Semiconductor signalling output circuits (Ox)	4	303 part 11
Semiconductor safety output circuits (OSx)	4 PNP	303 part 12

### Quality marks:



EC type examination certificate: M6A 16 06 75157 010  
 UL approval: E131787  
 CCC approval: 2013010305640211  
 TÜV SÜD approval: Z10 16 05 75157 009  
 EAC approval: RU C-IT.YT03.B.00035/19

### Pin assignment

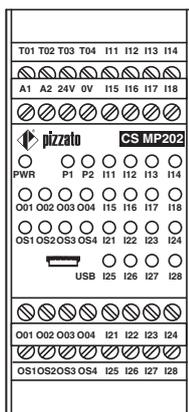

### Internal block diagram

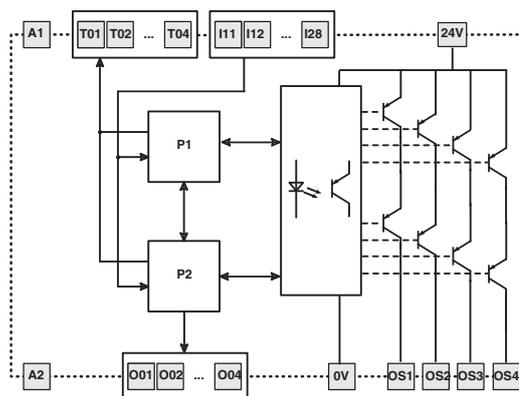

### Code structure

# CS MP202M0

#### Connection type

- M** Connector with screw terminals
- X** Connector with spring terminals



**Main features**

- For safety applications up to SIL CL 3/PL e
- Supply voltage: 24 Vdc
- Gemnis Studio for easy and intuitive programming and program simulation
- Large selection of logical blocks for the management of external devices and programs
- Custom configured versions available on request

**Quality marks:**



EC type examination certificate: M6A 16 06 75157 010  
 UL approval: E131787  
 CCC approval: 2013010305640211  
 TÜV SÜD approval: Z10 16 05 75157 009  
 EAC approval: RU C-IT.YT03.B.00035/19

**General data**

Parameter:	Value:	Page:
SIL CL acc. to EN IEC 62061	up to SIL CL 3	
Performance Level (PL) acc. to EN ISO 13849-1	up to PL e	
Safety category acc. to EN ISO 13849-1	up to cat. 4	
MTTF <sub>D</sub>	103	
PFH <sub>D</sub>	1.61E-09	
Mission time	20 years	
System response time	< 40 ms	
Dimensions (HxLxW)	111.5x45x99 mm	
Housing data		303 part 1
Environmental data		303 part 2
Supply		303 part 3
In compliance with standards		303 part 4
Programming software	Gemis Studio	303 part 5
USB port	Yes	
Safety inputs (Ix)	12	303 part 6
Test outputs (Tx)	4	303 part 10
Semiconductor signalling output circuits (Ox)	4	303 part 11
Safety relay circuits	3NO+1NO	303 part 14

**Pin assignment**

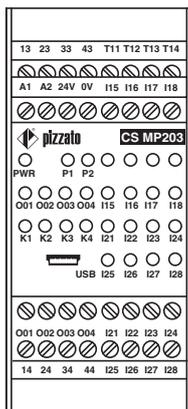

**Internal block diagram**

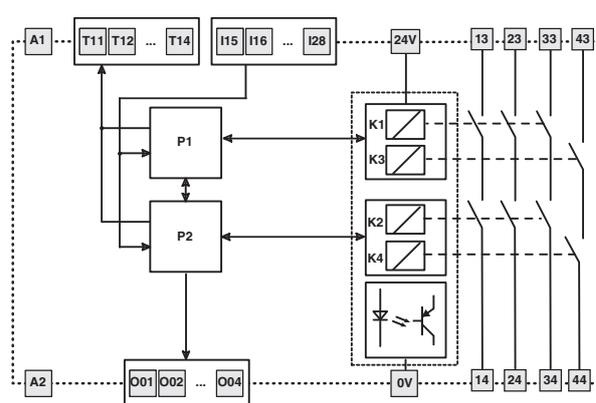

**Code structure**

**CS MP203M0**

**Connection type**

- M** Connector with screw terminals
- X** Connector with spring terminals



**Main features**

- For safety applications up to SIL CL 3/PL e
- Supply voltage: 24 Vdc
- Gemnis Studio for easy and intuitive programming and program simulation
- Large selection of logical blocks for the management of external devices and programs
- Custom configured versions available on request

**Quality marks:**



EC type examination certificate: M6A 16 06 75157 010  
 UL approval: E131787  
 CCC approval: 2013010305640211  
 TÜV SÜD approval: Z10 16 05 75157 009  
 EAC approval: RU C-IT.YT03.B.00035/19

**General data**

Parameter:	Value:	Page:
SIL CL acc. to EN IEC 62061	up to SIL CL 3	
Performance Level (PL) acc. to EN ISO 13849-1	up to PL e	
Safety category acc. to EN ISO 13849-1	up to cat. 4	
MTTF <sub>D</sub>	134	
PFH <sub>D</sub>	1.52E-09	
Mission time	20 years	
System response time	< 40 ms	
Dimensions (HxLxW)	111.5x45x99 mm	
Housing data		303 part 1
Environmental data		303 part 2
Supply		303 part 3
In compliance with standards		303 part 4
Programming software	Gemis Studio	303 part 5
USB port	Yes	
Safety inputs (Ix)	12	303 part 6
Test outputs (Tx)	4	303 part 10
Semiconductor signalling output circuits (Ox)	4	303 part 11
Safety relay circuits	3NO	303 part 14

**Pin assignment**

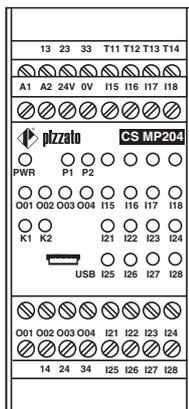

**Internal block diagram**

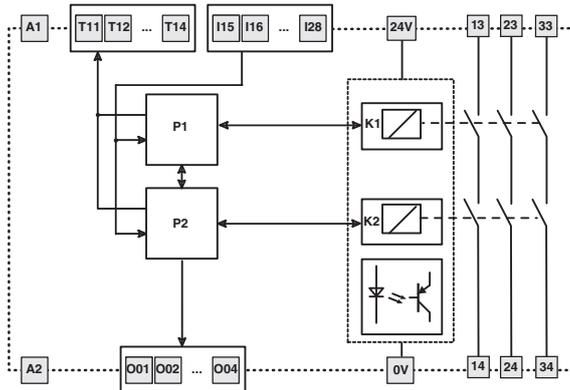

**Code structure**

**CS MP204M0**

**Connection type**

- M** Connector with screw terminals
- X** Connector with spring terminals



**Main features**

- For safety applications up to SIL CL 3/PL e
- Supply voltage: 24 Vdc
- Gemnis Studio for easy and intuitive programming and program simulation
- Large selection of logical blocks for the management of external devices and programs
- Custom configured versions available on request

**Quality marks:**



EC type examination certificate: M6A 16 06 75157 010  
 UL approval: E131787  
 CCC approval: 2013010305640211  
 TÜV SÜD approval: Z10 16 05 75157 009  
 EAC approval: RU C-IT.YT03.B.00035/19

**General data**

Parameter:	Value:	Page:
SIL CL acc. to EN IEC 62061	up to SIL CL 3	
Performance Level (PL) acc. to EN ISO 13849-1	up to PL e	
Safety category acc. to EN ISO 13849-1	up to cat. 4	
MTTF <sub>D</sub>	373	
PFH <sub>D</sub>	2.19E-09	
Mission time	20 years	
System response time	< 30 ms	
Dimensions (HxLxW)	111.5x45x99 mm	
Housing data		303 part 1
Environmental data		303 part 2
Supply		303 part 3
In compliance with standards		303 part 4
Programming software	Gemis Studio	303 part 5
USB port	Yes	
Safety inputs (Ix)	4	303 part 6
Decoupled digital inputs (Jx)	4	303 part 7
Inputs for frequency signals from 0 to 4 kHz (Fx)	4	303 part 9
Test outputs (Tx)	4	303 part 10
Semiconductor signalling output circuits (Ox)	4	303 part 11
Semiconductor safety output circuits (OSx)	4 PNP	303 part 12

**Pin assignment**

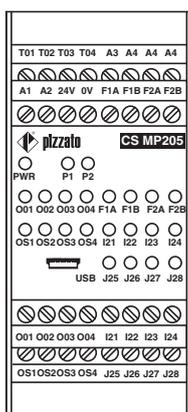

**Internal block diagram**

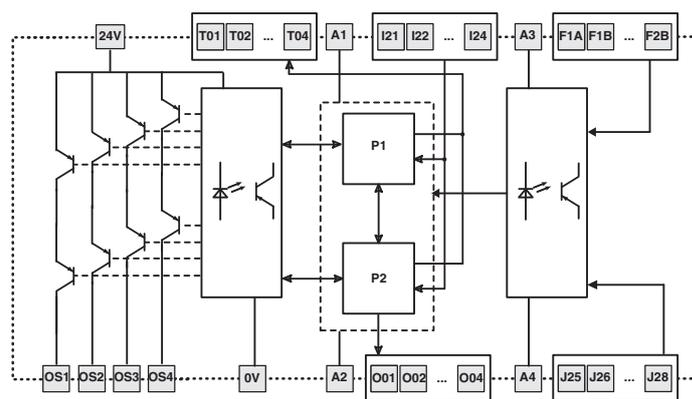

**Code structure**

**CS MP205M0**

**Connection type**

- M** Connector with screw terminals
- X** Connector with spring terminals





### Main features

- For safety applications up to SIL CL 3/PL e
- Supply voltage: 24 Vdc
- Gemnis Studio for easy and intuitive programming and program simulation
- Large selection of logical blocks for the management of external devices and programs
- Custom configured versions available on request

### General data

Parameter:	Value:	Page:
SIL CL acc. to EN IEC 62061	up to SIL CL 3	
Performance Level (PL) acc. to EN ISO 13849-1	up to PL e	
Safety category acc. to EN ISO 13849-1	up to cat. 4	
MTTF <sub>D</sub>	3314	
PFH <sub>D</sub>	1.09E-09	
Mission time	20 years	
System response time	< 30 ms	
Dimensions (HxLxW)	111.5x45x99 mm	
Housing data		303 part 1
Environmental data		303 part 2
Supply		303 part 3
In compliance with standards		303 part 4
Programming software	Gemis Studio	303 part 5
USB port	Yes	
Safety inputs (Ix)	8	303 part 6
Test outputs (Tx)	4	303 part 10
Semiconductor signalling output circuits (Ox)	12	303 part 11
Semiconductor safety output circuits (OSx)	4 PNP	303 part 12

### Quality marks:



EC type examination certificate: M6A 16 06 75157 010  
 UL approval: E131787  
 CCC approval: 2013010305640211  
 TÜV SÜD approval: Z10 16 05 75157 009  
 EAC approval: RU C-IT.YT03.B.00035/19

### Pin assignment

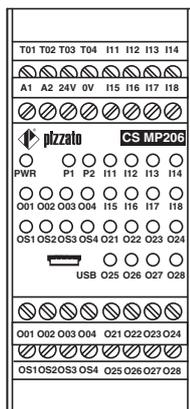

### Internal block diagram

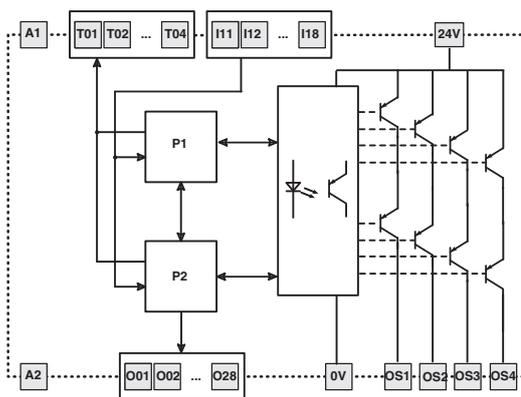

### Code structure

# CS MP206M0

#### Connection type

- M** Connector with screw terminals
- X** Connector with spring terminals



**Main features**

- For safety applications up to SIL CL 3/PL e
- Supply voltage: 24 Vdc
- Gemnis Studio for easy and intuitive programming and program simulation
- Large selection of logical blocks for the management of external devices and programs
- Custom configured versions available on request

**Quality marks:**



EC type examination certificate: M6A 16 06 75157 010  
 UL approval: E131787  
 CCC approval: 2013010305640211  
 TÜV SÜD approval: Z10 16 05 75157 009  
 EAC approval: RU C-IT.YT03.B.00035/19

**General data**

Parameter:	Value:	Page:
SIL CL acc. to EN IEC 62061	up to SIL CL 3	
Performance Level (PL) acc. to EN ISO 13849-1	up to PL e	
Safety category acc. to EN ISO 13849-1	up to cat. 4	
MTTF <sub>D</sub>	431	
PFH <sub>D</sub>	7.08E-09	
Mission time	20 years	
System response time	< 30 ms	
Dimensions (HxLxW)	111.5x45x99 mm	
Housing data		303 part 1
Environmental data		303 part 2
Supply		303 part 3
In compliance with standards		303 part 4
Programming software	Gemis Studio	303 part 5
USB port	Yes	
Safety inputs (Ix)	4	303 part 6
Inputs for 4-20 mA analogue signals (Cx)	2	303 part 8
Test outputs (Tx)	4	303 part 10
Semiconductor signalling output circuits (Ox)	4	303 part 11
Semiconductor safety output circuits (OSx)	4 PNP	303 part 12

**Pin assignment**

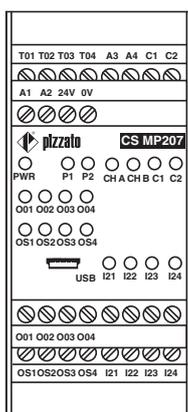

**Internal block diagram**

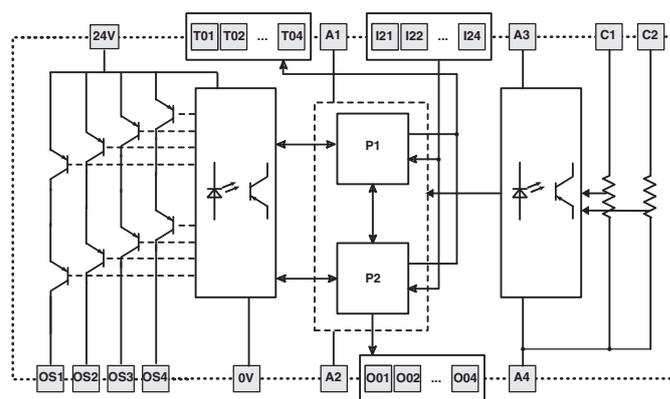

**Code structure**

**CS MP207M0**

**Connection type**

- M** Connector with screw terminals
- X** Connector with spring terminals



### Main features

- For safety applications up to SIL CL 3/PL e
- Supply voltage: 24 Vdc
- Gemnis Studio for easy and intuitive programming and program simulation
- Large selection of logical blocks for the management of external devices and programs
- Custom configured versions available on request

### General data

Parameter:	Value:	Page:
SIL CL acc. to EN IEC 62061	up to SIL CL 3	
Performance Level (PL) acc. to EN ISO 13849-1	up to PL e	
Safety category acc. to EN ISO 13849-1	up to cat. 4	
MTTF <sub>D</sub>	633	
PFH <sub>D</sub>	7.02E-09	
Mission time	20 years	
System response time	< 30 ms	
Dimensions (HxLxW)	111.5x45x99 mm	
Housing data		303 part 1
Environmental data		303 part 2
Supply		303 part 3
In compliance with standards		303 part 4
Programming software	Gemis Studio	303 part 5
USB port	Yes	
Safety inputs (Ix)	16	303 part 6
Test outputs (Tx)	4	303 part 10
Semiconductor safety output circuits (OSx)	8 PNP	303 part 13

### Quality marks:



EC type examination certificate: M6A 16 06 75157 010  
 UL approval: E131787  
 CCC approval: 2013010305640211  
 TÜV SÜD approval: Z10 16 05 75157 009  
 EAC approval: RU C-IT.YT03.B.00035/19

### Pin assignment

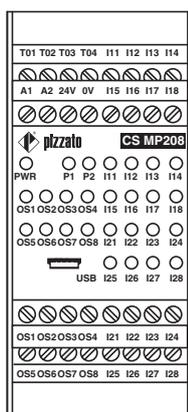

### Internal block diagram

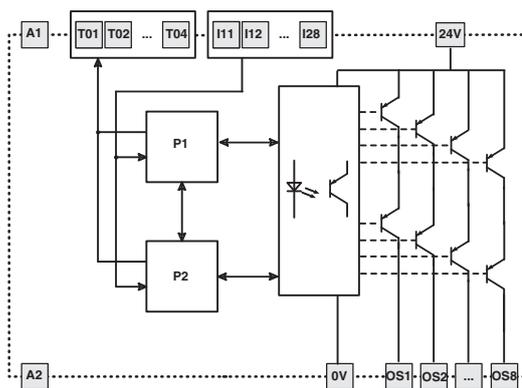

### Code structure

# CS MP208M0

#### Connection type

- M** Connector with screw terminals
- X** Connector with spring terminals



**Main features**

- For safety applications up to SIL CL 3/PL e
- Supply voltage: 24 Vdc
- Gemnis Studio for easy and intuitive programming and program simulation
- Large selection of logical blocks for the management of external devices and programs
- Custom configured versions available on request

**General data**

Parameter:	Value:	Page:
SIL CL acc. to EN IEC 62061	up to SIL CL 3	
Performance Level (PL) acc. to EN ISO 13849-1	up to PL e	
Safety category acc. to EN ISO 13849-1	up to cat. 4	
MTTF <sub>D</sub>	128	
PFH <sub>D</sub>	1.88E-09	
Mission time	20 years	
System response time	< 40 ms	
Dimensions (HxLxW)	111.5x67.5x99 mm	
Housing data		303 part 1
Environmental data		303 part 2
Supply		303 part 3
In compliance with standards		303 part 4
Programming software	Gemis Studio	303 part 5
USB port	Yes	
Safety inputs (Ix)	24	303 part 6
Test outputs (Tx)	8	303 part 10
Semiconductor signalling output circuits (Ox)	4	303 part 11
Safety relay circuits	3NO	303 part 14

**Quality marks:**



EC type examination certificate: M6A 16 06 75157 010  
 UL approval: E131787  
 CCC approval: 2013010305640211  
 TÜV SÜD approval: Z10 16 05 75157 009  
 EAC approval: RU C-IT.YT03.B.00035/19

**Pin assignment**

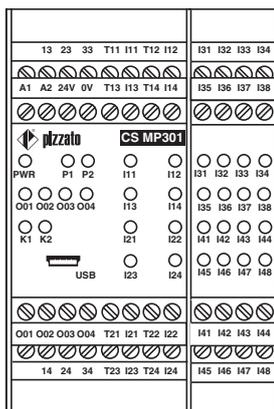

**Internal block diagram**

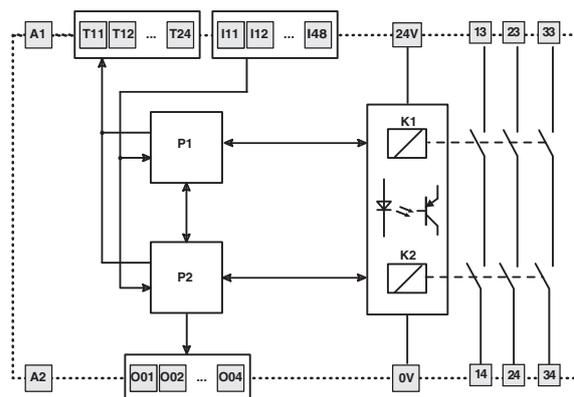

**Code structure**

**CS MP301M0**

**Connection type**

- M** Connector with screw terminals
- X** Connector with spring terminals



### Main features

- For safety applications up to SIL CL 3/PL e
- Supply voltage: 24 Vdc
- Gemnis Studio for easy and intuitive programming and program simulation
- Large selection of logical blocks for the management of external devices and programs
- Custom configured versions available on request

### General data

Parameter:	Value:	Page:
SIL CL acc. to EN IEC 62061	up to SIL CL 3	
Performance Level (PL) acc. to EN ISO 13849-1	up to PL e	
Safety category acc. to EN ISO 13849-1	up to cat. 4	
MTTF <sub>D</sub>	535	
PFH <sub>D</sub>	1.57E-09	
Mission time	20 years	
System response time	< 30 ms	
Dimensions (HxLxW)	111.5x67.5x99 mm	
Housing data		303 part 1
Environmental data		303 part 2
Supply		303 part 3
In compliance with standards		303 part 4
Programming software	Gemis Studio	303 part 5
USB port	Yes	
Safety inputs (Ix)	24	303 part 6
Test outputs (Tx)	12	303 part 10
Semiconductor signalling output circuits (Ox)	4	303 part 11
Semiconductor safety output circuits (OSx)	4 PNP	303 part 12

### Quality marks:



EC type examination certificate: M6A 16 06 75157 010  
 UL approval: E131787  
 CCC approval: 2013010305640211  
 TÜV SÜD approval: Z10 16 05 75157 009  
 EAC approval: RU C-IT.YT03.B.00035/19

### Pin assignment

T01 T02 T03 T04	T11 T11 T12 I12	I31 I32 I33 I34
A1 A2 24V 0V	T13 I13 T14 I14	I35 I36 I37 I38
PWR P1 P2	I11 I12	I31 I32 I33 I34
O01 O02 O03 O04	I13 I14	I35 I36 I37 I38
OS1 OS2 OS3 OS4	I21 I22	I41 I42 I43 I44
USB I23	I24	I45 I46 I47 I48
O01 O02 O03 O04	T21 I21 T22 I22	I41 I42 I43 I44
OS1 OS2 OS3 OS4	T23 I23 T24 I24	I45 I46 I47 I48

### Internal block diagram

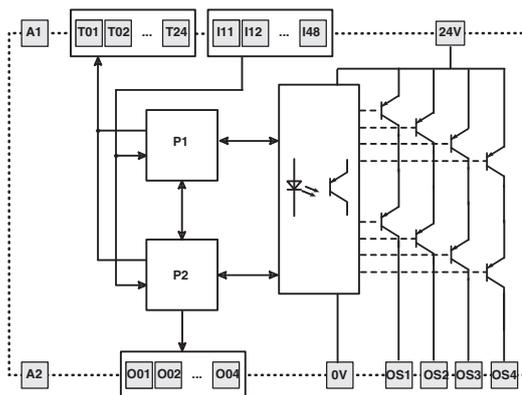

### Code structure

# CS MP302M0

#### Connection type

- M** Connector with screw terminals
- X** Connector with spring terminals



**Main features**

- For safety applications up to SIL CL 3/PL e
- Supply voltage: 24 Vdc
- Gemnis Studio for easy and intuitive programming and program simulation
- Large selection of logical blocks for the management of external devices and programs
- Custom configured versions available on request

**General data**

Parameter:	Value:	Page:
SIL CL acc. to EN IEC 62061	up to SIL CL 3	
Performance Level (PL) acc. to EN ISO 13849-1	up to PL e	
Safety category acc. to EN ISO 13849-1	up to cat. 4	
MTTF <sub>D</sub>	485	
PFH <sub>D</sub>	1.76E-09	
Mission time	20 years	
System response time	< 30 ms	
Dimensions (HxLxW)	111.5x67.5x99 mm	
Housing data		303 part 1
Environmental data		303 part 2
Supply		303 part 3
In compliance with standards		303 part 4
Programming software	Gemis Studio	303 part 5
USB port	Yes	
Safety inputs (Ix)	32	303 part 6
Test outputs (Tx)	4	303 part 10
Semiconductor signalling output circuits (Ox)	4	303 part 11
Semiconductor safety output circuits (OSx)	4 PNP	303 part 12

**Quality marks:**



EC type examination certificate: M6A 16 06 75157 010  
 UL approval: E131787  
 CCC approval: 2013010305640211  
 TÜV SÜD approval: Z10 16 05 75157 009  
 EAC approval: RU C-IT.YT03.B.00035/19

**Pin assignment**

T01 T02 T03 T04	I11 I12 I13 I14	I31 I32 I33 I34
A1 A2 24V 0V	I15 I16 I17 I18	I35 I36 I37 I38
<b>CS MP303</b>		
PWR P1 P2	I11 I12 I13 I14	I31 I32 I33 I34
O01 O02 O03 O04	I15 I16 I17 I18	I35 I36 I37 I38
OS1 OS2 OS3 OS4	I21 I22 I23 I24	I41 I42 I43 I44
USB	I25 I26 I27 I28	I45 I46 I47 I48
O01 O02 O03 O04	I21 I22 I23 I24	I41 I42 I43 I44
OS1 OS2 OS3 OS4	I25 I26 I27 I28	I45 I46 I47 I48

**Internal block diagram**

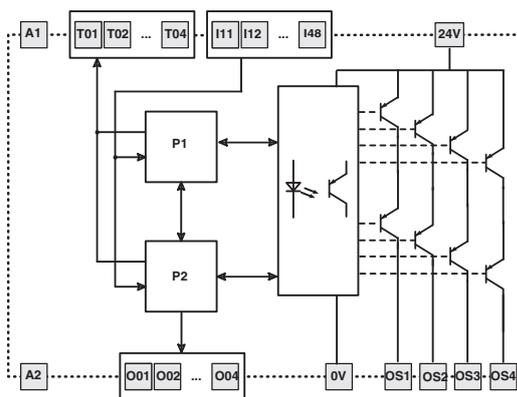

**Code structure**

**CS MP303M0**

**Connection type**

- M** Connector with screw terminals
- X** Connector with spring terminals



### Main features

- For safety applications up to SIL CL 3/PL e
- Supply voltage: 24 Vdc
- Gemnis Studio for easy and intuitive programming and program simulation
- Large selection of logical blocks for the management of external devices and programs
- Custom configured versions available on request

### General data

Parameter:	Value:	Page:
SIL CL acc. to EN IEC 62061	up to SIL CL 3	
Performance Level (PL) acc. to EN ISO 13849-1	up to PL e	
Safety category acc. to EN ISO 13849-1	up to cat. 4	
MTTF <sub>D</sub>	98	
PFH <sub>D</sub>	2.05E-09	
Mission time	20 years	
System response time	< 40 ms	
Dimensions (HxLxW)	111.5x67.5x99 mm	
Housing data		303 part 1
Environmental data		303 part 2
Supply		303 part 3
In compliance with standards		303 part 4
Programming software	Gemis Studio	303 part 5
USB port	Yes	
Safety inputs (Ix)	28	303 part 6
Test outputs (Tx)	4	303 part 10
Semiconductor signalling output circuits (Ox)	4	303 part 11
Safety relay circuits	3NO+1NO	303 part 14

### Quality marks:



EC type examination certificate: M6A 16 06 75157 010  
 UL approval: E131787  
 CCC approval: 2013010305640211  
 TÜV SÜD approval: Z10 16 05 75157 009  
 EAC approval: RU C-IT.YT03.B.00035/19

### Pin assignment

13 23 33 43 T11 T12 T13 T14	I31 I32 I33 I34
A1 A2 24V 0V I15 I16 I17 I18	I35 I36 I37 I38
<b>pizzato</b> CS MP304	
PWR P1 P2	I31 I32 I33 I34
O01 O02 O03 O04 I15 I16 I17 I18	I35 I36 I37 I38
K1 K2 K3 K4 I21 I22 I23 I24	I41 I42 I43 I44
USB I25 I26 I27 I28	I45 I46 I47 I48
O01 O02 O03 O04 I21 I22 I23 I24	I41 I42 I43 I44
14 24 34 44 I25 I26 I27 I28	I45 I46 I47 I48

### Internal block diagram

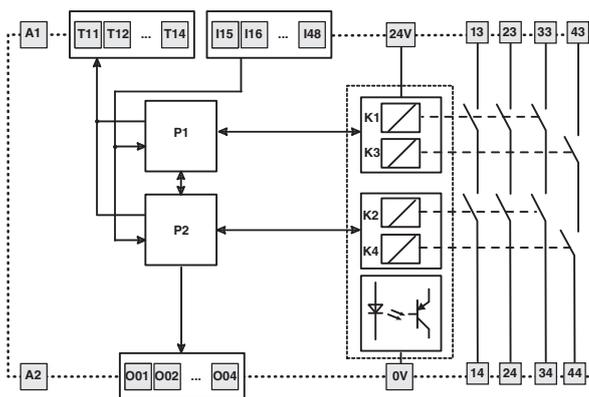

### Code structure

# CS MP304M0

#### Connection type

**M** Connector with screw terminals

**X** Connector with spring terminals



**Main features**

- For safety applications up to SIL CL 3/PL e
- Supply voltage: 24 Vdc
- Gemnis Studio for easy and intuitive programming and program simulation
- Large selection of logical blocks for the management of external devices and programs
- Custom configured versions available on request

**General data**

Parameter:	Value:	Page:
SIL CL acc. to EN IEC 62061	up to SIL CL 3	
Performance Level (PL) acc. to EN ISO 13849-1	up to PL e	
Safety category acc. to EN ISO 13849-1	up to cat. 4	
MTTF <sub>D</sub>	535	
PFH <sub>D</sub>	1.57E-09	
Mission time	20 years	
System response time	< 30 ms	
Dimensions (HxLxW)	111.5x67.5x99 mm	
Housing data		303 part 1
Environmental data		303 part 2
Supply		303 part 3
In compliance with standards		303 part 4
Programming software	Gemis Studio	303 part 5
USB port	Yes	
Safety inputs (Ix)	24	303 part 6
Test outputs (Tx)	4	303 part 10
Semiconductor signalling output circuits (Ox)	12	303 part 11
Semiconductor safety output circuits (OSx)	4 PNP	303 part 12

**Quality marks:**



EC type examination certificate: M6A 16 06 75157 010  
 UL approval: E131787  
 CCC approval: 2013010305640211  
 TÜV SÜD approval: Z10 16 05 75157 009  
 EAC approval: RU C-IT.YT03.B.00035/19

**Pin assignment**

T01 T02 T03 T04	I11 I12 I13 I14	I31 I32 I33 I34
A1 A2 24V 0V	I15 I16 I17 I18	I35 I36 I37 I38
<b>CS MP305</b>		
PWR P1 P2	I11 I12 I13 I14	I31 I32 I33 I34
O01 O02 O03 O04	I15 I16 I17 I18	I35 I36 I37 I38
OS1 OS2 OS3 OS4	I21 I22 I23 I24	O41 O42 O43 O44
USB	I25 I26 I27 I28	O45 O46 O47 O48
O01 O02 O03 O04	I21 I22 I23 I24	O41 O42 O43 O44
OS1 OS2 OS3 OS4	I25 I26 I27 I28	O45 O46 O47 O48

**Internal block diagram**

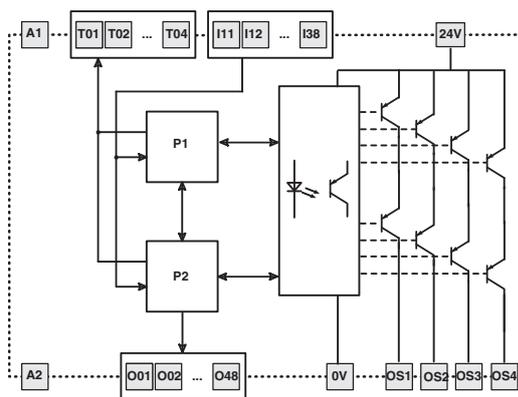

**Code structure**

**CS MP305M0**

**Connection type**

- M** Connector with screw terminals
- X** Connector with spring terminals





### Main features

- For safety applications up to SIL CL 3/PL e
- Supply voltage: 24 Vdc
- Gemnis Studio for easy and intuitive programming and program simulation
- Large selection of logical blocks for the management of external devices and programs
- Custom configured versions available on request

### General data

Parameter:	Value:	Page:
SIL CL acc. to EN IEC 62061	up to SIL CL 3	
Performance Level (PL) acc. to EN ISO 13849-1	up to PL e	
Safety category acc. to EN ISO 13849-1	up to cat. 4	
MTTF <sub>D</sub>	100	
PFH <sub>D</sub>	1.86E-09	
Mission time	20 years	
System response time	< 40 ms	
Dimensions (HxLxW)	111.5x67.5x99 mm	
Housing data		303 part 1
Environmental data		303 part 2
Supply		303 part 3
In compliance with standards		303 part 4
Programming software	Gemis Studio	303 part 5
USB port	Yes	
Safety inputs (Ix)	20	303 part 6
Test outputs (Tx)	4	303 part 10
Semiconductor signalling output circuits (Ox)	12	303 part 11
Safety relay circuits	3NO+1NO	303 part 14

### Quality marks:



EC type examination certificate: M6A 16 06 75157 010  
 UL approval: E131787  
 CCC approval: 2013010305640211  
 TÜV SÜD approval: Z10 16 05 75157 009  
 EAC approval: RU C-IT.YT03.B.00035/19

### Pin assignment

13 23 33 43 T11 T12 T13 T14	I31 I32 I33 I34
A1 A2 24V 0V I15 I16 I17 I18	I35 I36 I37 I38
CS MP306	
PWR P1 P2	I31 I32 I33 I34
O01 O02 O03 O04 I15 I16 I17 I18	I35 I36 I37 I38
K1 K2 K3 K4 I21 I22 I23 I24	O41 O42 O43 O44
USB I25 I26 I27 I28	O45 O46 O47 O48
O01 O02 O03 O04 I21 I22 I23 I24	O41 O42 O43 O44
O05 O06 O07 O08 I25 I26 I27 I28	O45 O46 O47 O48

### Internal block diagram

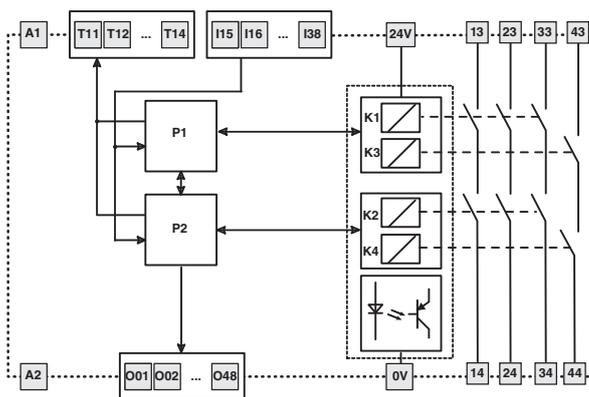

### Code structure

## CS MP306M0

#### Connection type

- M** Connector with screw terminals
- X** Connector with spring terminals



**Main features**

- For safety applications up to SIL CL 3/PL e
- Supply voltage: 24 Vdc
- Gemnis Studio for easy and intuitive programming and program simulation
- Large selection of logical blocks for the management of external devices and programs
- Custom configured versions available on request

**Quality marks:**



EC type examination certificate: M6A 16 06 75157 010  
 UL approval: E131787  
 CCC approval: 2013010305640211  
 TÜV SÜD approval: Z10 16 05 75157 009  
 EAC approval: RU C-IT.YT03.B.00035/19

**General data**

Parameter:	Value:	Page:
SIL CL acc. to EN IEC 62061	up to SIL CL 3	
Performance Level (PL) acc. to EN ISO 13849-1	up to PL e	
Safety category acc. to EN ISO 13849-1	up to cat. 4	
MTTF <sub>D</sub>	289	
PFH <sub>D</sub>	8.38E-09	
Mission time	20 years	
System response time	< 30 ms	
Dimensions (HxLxW)	111.5x67.5x99 mm	
Housing data		303 part 1
Environmental data		303 part 2
Supply		303 part 3
In compliance with standards		303 part 4
Programming software	Gemis Studio	303 part 5
USB port	Yes	
Safety inputs (Ix)	8	303 part 6
Decoupled digital inputs (Jx)	4	303 part 7
Inputs for 4-20 mA analogue signals (Cx)	2	303 part 8
Inputs for frequency signals from 0 to 4 kHz (Fx)	4	303 part 9
Test outputs (Tx)	4	303 part 10
Semiconductor signalling output circuits (Ox)	4	303 part 11
Semiconductor safety output circuits (OSx)	4 PNP	303 part 12

**Pin assignment**

T01 T02 T03 T04	A3 A4 A4	A5 A6 C1 C2
A1 A2 24V 0V	F1A F1B F2A F2B	
O01 O02 O03 O04	F1A F1B F2A F2B	
OS1 OS2 OS3 OS4	I21 I22 I23 I24	
USB J25 J26 J27 J28	I41 I42 I43 I44	
O01 O02 O03 O04	I21 I22 I23 I24	
OS1 OS2 OS3 OS4	J25 J26 J27 J28	
	I41 I42 I43 I44	

**Internal block diagram**

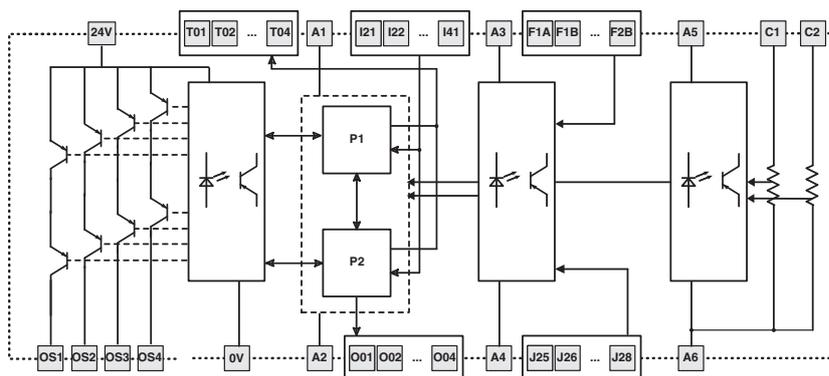

**Code structure**

**CS MP307M0**

**Connection type**

- M** Connector with screw terminals
- X** Connector with spring terminals



**Main features**

- For safety applications up to SIL CL 3/PL e
- Supply voltage: 24 Vdc
- Gemnis Studio for easy and intuitive programming and program simulation
- Large selection of logical blocks for the management of external devices and programs
- Custom configured versions available on request

**General data**

Parameter:	Value:	Page:
SIL CL acc. to EN IEC 62061	up to SIL CL 3	
Performance Level (PL) acc. to EN ISO 13849-1	up to PL e	
Safety category acc. to EN ISO 13849-1	up to cat. 4	
MTTF <sub>D</sub>	548	
PFH <sub>D</sub>	7.27E-09	
Mission time	20 years	
System response time	< 30 ms	
Dimensions (HxLxW)	111.5x67.5x99 mm	
Housing data		303 part 1
Environmental data		303 part 2
Supply		303 part 3
In compliance with standards		303 part 4
Programming software	Gemis Studio	303 part 5
USB port	Yes	
Safety inputs (Ix)	24	303 part 6
Test outputs (Tx)	4	303 part 10
Semiconductor signalling output circuits (Ox)	8	303 part 11
Semiconductor safety output circuits (OSx)	8 PNP	303 part 13

**Quality marks:**



EC type examination certificate: M6A 16 06 75157 010  
 UL approval: E131787  
 CCC approval: 2013010305640211  
 TÜV SÜD approval: Z10 16 05 75157 009  
 EAC approval: RU C-IT.YT03.B.00035/19

**Pin assignment**

T01 T02 T03 T04	I11 I12 I13 I14	I31 I32 I33 I34
A1 A2 24V 0V	I15 I16 I17 I18	I35 I36 I37 I38
PWR P1 P2	I11 I12 I13 I14	I31 I32 I33 I34
OS1 OS2 OS3 OS4	I15 I16 I17 I18	I35 I36 I37 I38
OS5 OS6 OS7 OS8	I21 I22 I23 I24	O41 O42 O43 O44
USB	I25 I26 I27 I28	O45 O46 O47 O48

**Internal block diagram**

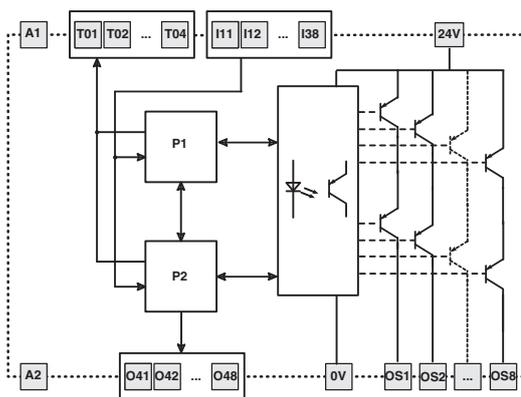

**Code structure**

**CS MP308M0**

**Connection type**

- M** Connector with screw terminals
- X** Connector with spring terminals



**Main features**

- For safety applications up to SIL CL 3/PL e
- Supply voltage: 24 Vdc
- Gemnis Studio for easy and intuitive programming and program simulation
- Large selection of logical blocks for the management of external devices and programs
- Custom configured versions available on request

**Quality marks:**



EC type examination certificate: M6A 16 06 75157 010  
 UL approval: E131787  
 CCC approval: 2013010305640211  
 TÜV SÜD approval: Z10 16 05 75157 009  
 EAC approval: RU C-IT.YT03.B.00035/19

**General data**

Parameter:	Value:	Page:
SIL CL acc. to EN IEC 62061	up to SIL CL 3	
Performance Level (PL) acc. to EN ISO 13849-1	up to PL e	
Safety category acc. to EN ISO 13849-1	up to cat. 4	
MTTF <sub>D</sub>	496	
PFH <sub>D</sub>	7.46E-09	
Mission time	20 years	
Mission time	20 years	
System response time	< 30 ms	
Dimensions (HxLxW)	111.5x67.5x99 mm	
Housing data		303 part 1
Environmental data		303 part 2
Supply		303 part 3
In compliance with standards		303 part 4
Programming software	Gemis Studio	303 part 5
USB port	Yes	
Safety inputs (Ix)	32	303 part 6
Test outputs (Tx)	4	303 part 10
Semiconductor safety output circuits (OSx)	8 PNP	303 part 13

**Pin assignment**

T01 T02 T03 T04	I11 I12 I13 I14	I31 I32 I33 I34
A1 A2 24V 0V	I15 I16 I17 I18	I35 I36 I37 I38
<b>pizzato CS MP309</b>		
PWR P1 P2	I11 I12 I13 I14	I31 I32 I33 I34
OS1 OS2 OS3 OS4	I15 I16 I17 I18	I35 I36 I37 I38
OS5 OS6 OS7 OS8	I21 I22 I23 I24	I41 I42 I43 I44
USB	I25 I26 I27 I28	I45 I46 I47 I48
OS1 OS2 OS3 OS4	I21 I22 I23 I24	I41 I42 I43 I44
OS5 OS6 OS7 OS8	I25 I26 I27 I28	I45 I46 I47 I48

**Internal block diagram**

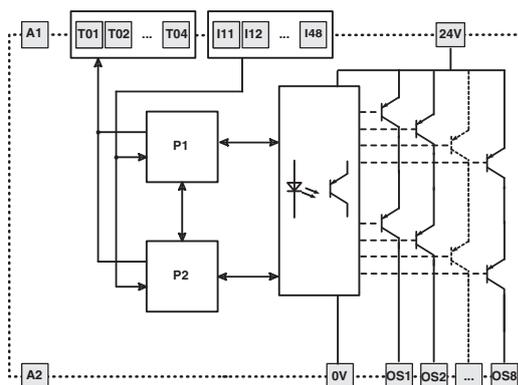

**Code structure**

**CS MP309M0**

**Connection type**

- M** Connector with screw terminals
- X** Connector with spring terminals

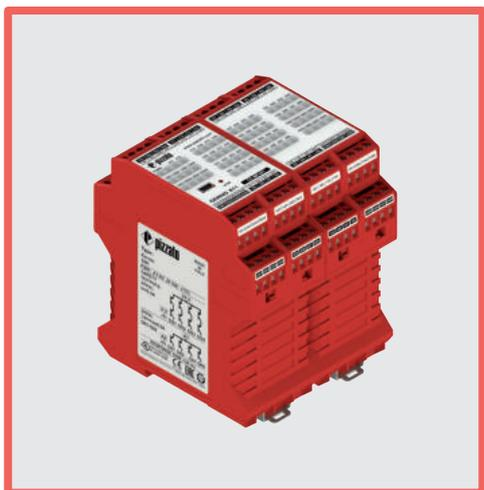

### Main features

- For safety applications up to SIL CL 3/PL e
- Supply voltage: 24 Vdc
- Gemnis Studio for easy and intuitive programming and program simulation
- Large selection of logical blocks for the management of external devices and programs
- Custom configured versions available on request

### Quality marks:



EC type examination certificate: M6A 16 06 75157 010  
 UL approval: E131787  
 CCC approval: 2013010305640211  
 TÜV SÜD approval: Z10 16 05 75157 009  
 EAC approval: RU C-IT.YT03.B.00035/19

### General data

Parameter:	Value:	Page:
SIL CL acc. to EN IEC 62061	up to SIL CL 3	
Performance Level (PL) acc. to EN ISO 13849-1	up to PL e	
Safety category acc. to EN ISO 13849-1	up to cat. 4	
MTTF <sub>D</sub>	434	
PFH <sub>D</sub>	1.73E-09	
Mission time	20 years	
System response time	< 30 ms	
Dimensions (HxLxW)	111.5x90x99 mm	
Housing data		303 part 1
Environmental data		303 part 2
Supply		303 part 3
In compliance with standards		303 part 4
Programming software	Gemis Studio	303 part 5
USB port	Yes	
Safety inputs (Ix)	40	303 part 6
Test outputs (Tx)	4	303 part 10
Semiconductor signalling output circuits (Ox)	12	303 part 11
Semiconductor safety output circuits (OSx)	4 PNP	303 part 12

### Pin assignment

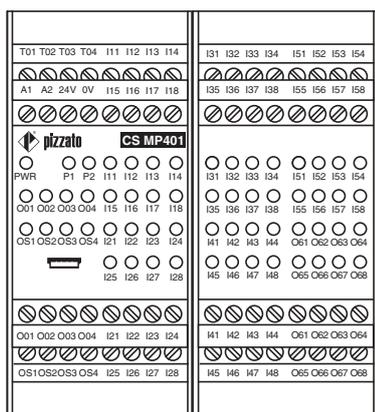

### Internal block diagram

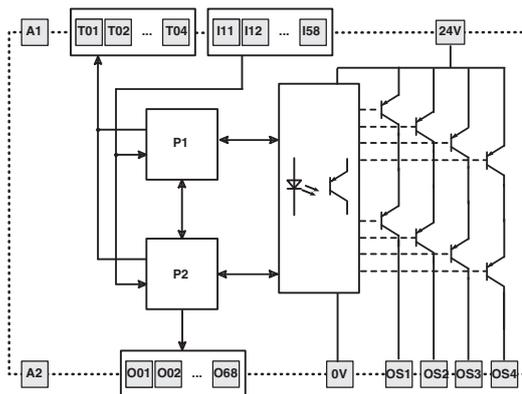

### Code structure

# CS MP401M0

#### Connection type

- M** Connector with screw terminals
- X** Connector with spring terminals

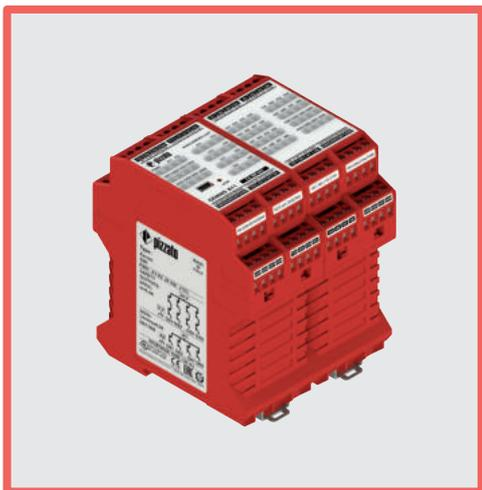

**Main features**

- For safety applications up to SIL CL 3/PL e
- Supply voltage: 24 Vdc
- Gemnis Studio for easy and intuitive programming and program simulation
- Large selection of logical blocks for the management of external devices and programs
- Custom configured versions available on request

**General data**

Parameter:	Value:	Page:
SIL CL acc. to EN IEC 62061	up to SIL CL 3	
Performance Level (PL) acc. to EN ISO 13849-1	up to PL e	
Safety category acc. to EN ISO 13849-1	up to cat. 4	
MTTF <sub>D</sub>	478	
PFH <sub>D</sub>	7.24E-09	
Mission time	20 years	
System response time	< 30 ms	
Dimensions (HxLxW)	111.5x90x99 mm	
Housing data		303 part 1
Environmental data		303 part 2
Supply		303 part 3
In compliance with standards		303 part 4
Programming software	Gemis Studio	303 part 5
USB port	Yes	
Safety inputs (Ix)	32	303 part 6
Test outputs (Tx)	12	303 part 10
Semiconductor signalling output circuits (Ox)	8	303 part 11
Semiconductor safety output circuits (OSx)	8 PNP	303 part 13

**Quality marks:**



EC type examination certificate: M6A 16 06 75157 010  
 UL approval: E131787  
 CCC approval: 2013010305640211  
 TÜV SÜD approval: Z10 16 05 75157 009  
 EAC approval: RU C-IT.YT03.B.00035/19

**Pin assignment**

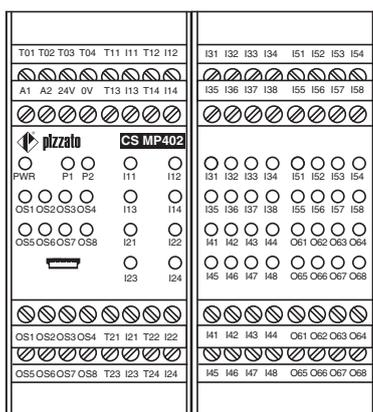

**Internal block diagram**

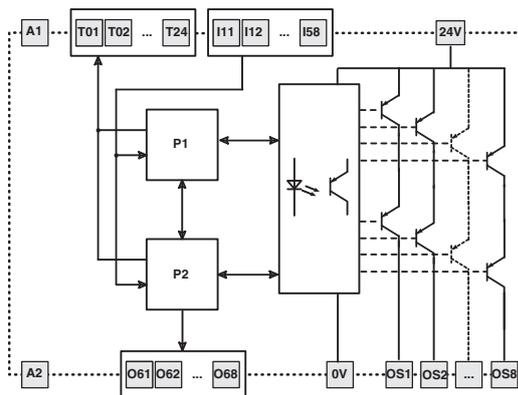

**Code structure**

**CS MP402M0**

**Connection type**

- M** Connector with screw terminals
- X** Connector with spring terminals

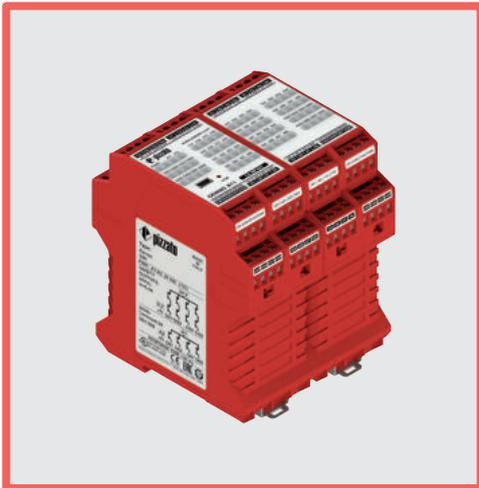

### Main features

- For safety applications up to SIL CL 3/PL e
- Supply voltage: 24 Vdc
- Gemnis Studio for easy and intuitive programming and program simulation
- Large selection of logical blocks for the management of external devices and programs
- Custom configured versions available on request

### General data

Parameter:	Value:	Page:
SIL CL acc. to EN IEC 62061	up to SIL CL 3	
Performance Level (PL) acc. to EN ISO 13849-1	up to PL e	
Safety category acc. to EN ISO 13849-1	up to cat. 4	
MTTF <sub>D</sub>	438	
PFH <sub>D</sub>	7.42E-09	
Mission time	20 years	
System response time	< 30 ms	
Dimensions (HxLxW)	111.5x90x99 mm	
Housing data		303 part 1
Environmental data		303 part 2
Supply		303 part 3
In compliance with standards		303 part 4
Programming software	Gemis Studio	303 part 5
USB port	Yes	
Safety inputs (Ix)	40	303 part 6
Test outputs (Tx)	4	303 part 10
Semiconductor signalling output circuits (Ox)	8	303 part 11
Semiconductor safety output circuits (OSx)	8 PNP	303 part 13

### Quality marks:



EC type examination certificate: M6A 16 06 75157 010  
 UL approval: E131787  
 CCC approval: 2013010305640211  
 TÜV SÜD approval: Z10 16 05 75157 009  
 EAC approval: RU C-IT.YT03.B.00035/19

### Pin assignment

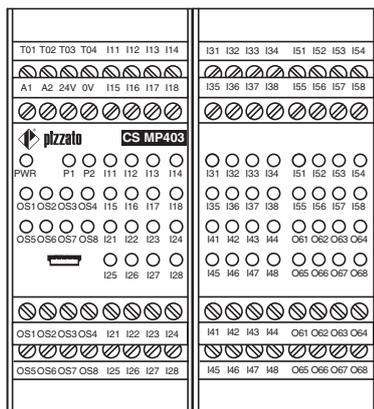

### Internal block diagram

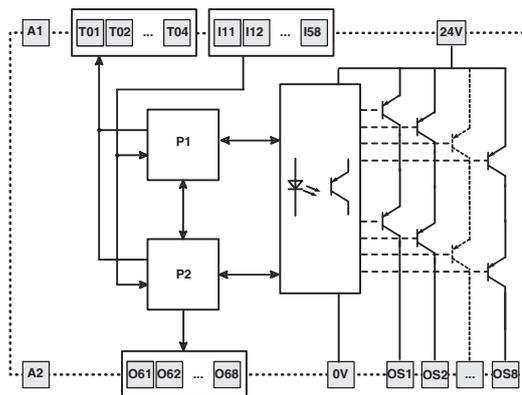

### Code structure

# CS MP403M0

#### Connection type

- M** Connector with screw terminals
- X** Connector with spring terminals

## Technical data

### 1) Housing

Housing:	polyamide PA 6.6, self-extinguishing V0 acc. to UL 94
Protection degree:	IP40 (housing) IP20 (terminal strip)
Dimensions, cable cross sections, terminal tightening torque:	page 317, design C/E

### 2) Environmental

Operating temperature:	0°C ... +55°C
Storage temperature:	-20°C ... +70°C
Pollution degree:	external 3, internal 2
Overvoltage category:	II

### 3) Power supply

Rated voltage A1-A2 ( $U_n$ ):	24 Vdc
Max. DC residual ripple in DC:	10%
Supply voltage tolerance:	$\pm 15\%$ of $U_n$
Rated consumption (w/o load):	< 3 W
Protection against short circuits:	PTC resistance, $I_h=0.5$ A
PTC response time:	Response time > 100 ms, release time > 3 s

Internal protection against short circuits on outputs (Tx, Ox): Electronic

Maximum current output of the module as the total current of the Ox and Tx outputs:	0.5 A
Self-test duration on startup:	< 2 s

### 4) Compliance with standards

EN 60947-1, EN 60947-5-1, EN 60204-1, EN ISO 13849-1, EN ISO 13855, EN 1037, EN ISO 12100, EN ISO 13850, EN 60529, EN 61000-6-2, EN 61000-6-3, EN 61326-1, EN 61326-3-1, EN 60664-1, EN 62061, EN 50581, UL 508, CSA C22.2 n° 14-95, GB/T14048.5-2017

### Compliance with the requirements of:

Machinery Directive 2006/42/EC, EMC Directive 2014/30/EU, RoHS Directive 2011/65/EU.

## Features approved by UL

Electrical ratings:	
Input:	4-48 inputs rated 24 V dc, 5 mA
Relay output:	230/240 Vac, 4 A general use, C300 pilot duty
Semiconductor output (when relay is not available):	up to 4 outputs rated 24 V dc, 500 mA or up to 8 outputs rated 24 Vdc, 400 mA
Semiconductor auxiliary output:	up to 32 outputs rated 24 V dc, 500 mA max
Auxiliary analogic outputs:	up to 4 rated 24 V dc, 20 mA max

#### Notes:

- Use 60 or 75°C copper (Cu) conductor and wire size No. 30-12 AWG, stranded or solid.
- The terminal tightening torque of 5-7 lb in.
- Only for 24 Vac/dc versions: supply from remote Class 2 source or limited voltage limited energy.

## Features approved by TÜV SÜD

Rated supply voltage $U_n$ :	24 Vdc (-15% ... +15%)
Ambient temperature:	0°C ... +55°C
Response time:	< 30 ms < 40 ms for versions with relay outputs

In compliance with standards: EN ISO 13849-1:2015 (Cat.4, PL e), EN 61508-1:2010 (SIL 3), EN 61508-2:2010 (SIL 3), EN 61508-3:2010 (SIL 3), EN 61508-4:2010 (SIL 3), EN 62061:2005/A1:2013/A2:2015 (SIL CL 3)

### 5) Gemnis Studio

The **Gemis Studio** software is the graphic development environment for the creation, simulation and debugging of programs designed for upload to Gemnis line modules.

The software is licensed to users wishing to program these modules, subject to prior registration at [www.gemis.com](http://www.gemis.com).

From our website you can download the latest version of the software, which allows you to program the safety modules of the Gemnis family.

### Gemis Studio software minimum download requirements

Computer and processor:	X86 with clock frequency of 1 GHz
Memory:	512 MB
Hard disk:	200 MB
Monitor:	Monitor with 1024x768 resolution or higher
Operating system:	Microsoft Windows 7 or Microsoft Windows 10 Microsoft Framework .NET 3.5 or higher Microsoft Report Viewer Acrobat Reader

### 6) Input circuits (Ix)

Voltage and current in the input circuits:	24 V, 5 mA
Input signals:	0-8 V (Off), 12-24 V (On)
Galvanic separation:	No
Minimum duration of input signal:	10 ms
Input signal filtering:	Yes, maximum interference period 0.4 ms
Maximum input resistance:	100 $\Omega$
Maximum input capacitance:	470 nF to ground 470 nF between two conductors

### 7) Decoupled input circuits (Jx)

Voltage and current in the input circuits:	24 V, 5 mA
Input signals:	0-8 V (Off), 12-24 V (On)
Galvanic separation:	Yes
Insulation voltage ( $U_i$ ):	500 V
Minimum duration of input signal:	10 ms
Input signal filtering:	Yes, maximum interference period 0.4 ms
Maximum input resistance:	100 $\Omega$
Maximum input capacitance:	470 nF to ground 470 nF between two conductors

NB: Voltage and current values indicated refer to the power supply terminals (Ax, see each module individually) of the board where the Jx type terminals are present

### 8) Analogue input circuits (Cx)

Rated supply voltage:	24 Vdc $\pm 15\%$
Analogue input type:	4-20 mA current loop
Measurement range:	0 ... 25 mA
Accuracy over entire measurement range:	1 % $\pm 1$ digit
Resolution:	0.01 mA
Input resistance:	100 Ohm
Maximum applicable current:	30 mA
Managed sensors:	"source" type with 2/3 wires
Galvanic separation:	Yes
Insulation voltage ( $U_i$ ):	500 V

NB: Voltage and current values indicated refer to the power supply terminals (Ax, see each module individually) of the board where the Cx type terminals are present



**9) Frequency input circuits (Fx)**

Rated supply voltage:	24 Vdc $\pm$ 15 %
Input circuit voltage and current:	24 Vdc, 7 mA
Check of the supply voltage of the connected proximity sensors:	24 Vdc $\pm$ 20%
Maximum detectable frequency:	4 kHz
Minimum detectable frequency:	1 Hz
Frequency detection accuracy:	1 % $\pm$ 1 digit
Resolution:	0.1 Hz
Minimum time for standstill detection:	1 s
Galvanic separation:	Yes
Insulation voltage ( $U_i$ ):	500 V

NB: Voltage and current values indicated refer to the power supply terminals (Ax, see each module individually) of the board where the Fx type terminals are present

**10) Circuits with Test signals (Tx)**

Signal type:	Pulsed 100 Hz 24V/0V, duty cycle 50%
Max. total current:	See Supply
Protected against short circuit:	Yes

**11) Semiconductor signalling output circuits (Ox)**

Output type:	PNP
Maximum current per output:	0.5 A
Max. total current:	see Supply
Impulse withstand voltage ( $U_{imp}$ ):	0.8 kV
Rated insulation voltage ( $U_i$ ):	32 V
Protected against short circuit:	Yes
Galvanic separation:	No

**12) Semiconductor safety output circuits (OSx) with 4 safety outputs**

Rated voltage 24V-0V:	24 Vdc
Number of outputs:	4
Output type:	PNP
Maximum current per output:	0.5 A
Max. total output current:	2 A
Minimum current:	10 mA
Maximum capacitive load to ground per output:	400 nF
Maximum inductive load per output:	500 mH
Protection fuse:	2 A type gG
Galvanic separation:	Yes
Impulse withstand voltage ( $U_{imp}$ ):	0.8 kV
Rated insulation voltage ( $U_i$ ):	32 V
Short circuit detection between outputs:	Yes
Duration of the deactivation impulses at the safety outputs:	< 300 $\mu$ s

**13) Semiconductor safety output circuits (OSx) with 8 safety outputs**

Rated voltage 24V-0V:	24 Vdc
Number of outputs:	8
Output type:	PNP
Maximum current per output:	0.4 A
Max. total output current:	3 A
Minimum current:	10 mA
Maximum capacitive load to ground per output:	400 nF
Maximum inductive load per output:	500 mH
Protection fuse:	4 A type gG

Galvanic separation:	Yes
Impulse withstand voltage ( $U_{imp}$ ):	0.8 kV
Rated insulation voltage ( $U_i$ ):	32 V
Short circuit detection between outputs:	Yes
Duration of the deactivation impulses at the safety outputs:	< 300 $\mu$ s

**14) Safety relay circuits**

Rated voltage 24V-0V:	24 Vdc
Contact type:	Forcibly guided contacts acc. to EN 50205
Material of the contacts:	gold-plated silver alloy
Maximum switching voltage:	230 Vac; 300 Vdc
Maximum current per contact:	6 A
Max. total current $\Sigma I_{th2}$ :	36 A <sup>2</sup>
Minimum current:	10 mA
Protection fuse:	4 A type gG
Maximum load:	1380 VA/W
Impulse withstand voltage ( $U_{imp}$ ):	4 kV
Rated insulation voltage ( $U_i$ ):	500 V
Utilization category (EN 60947-5-1):	AC15 ( $U_e=230V, I_e=3A$ ); DC13 ( $U_e=24V, I_e=4A$ ) (6 op. cycl./min.)
Utilization category (UL 508):	C300
Contact resistance:	< 100 m $\Omega$
Mechanical endurance:	>10 million operating cycles
Electrical endurance:	>100,000 operating cycles
Galvanic separation:	Yes

The number and the load capacity of output contacts can be increased by using expansion modules or contactors.  
See page 263-272.

## Introduction



An increasing number of users requires products which carry out several safety functions without needing the complex management of a safety PLC or the complex wiring of many traditional safety modules. Such problems arise mainly when the safety functions are typically greater than 3 or 4, and/or when managing a safety PLC software (software purchase, training courses, programming of all modules, software management and filing, updates etc.) turns out to be too great an overhead in relation to problem complexity.

Pizzato Elettrica introduces Gemnis, a series of electronic modules which are pre-programmed for specific customer applications or for generic safety macro-functions commonly used in industrial contexts. The following pages list some of the pre-programmed products for generic macro-functions commonly used in the industrial sector. These products are also available for individual purchase. Any customer requiring a product pre-programmed to their particular specification can contact the Pizzato Elettrica technical department (minimum volumes are requested).

The resulting advantages for customers typically include simplified product management (purchase of finished components) and reduced general costs (no software to be installed and managed, products are immediately operational).

All Gemnis series products are able to provide circuit solutions at SIL 3 (EN 62061), PL e (EN ISO 13849-1) or category 4 (EN ISO 13849-1) levels.

### Quality marks:



EC type examination certificate: M6A 16 06 75157 010

UL approval: E131787

CCC approval: 2013010305640211

TÜV SÜD approval: Z10 16 05 75157 009

EAC approval: RU C-IT.YT03.B.00035/19

## Code structure

### CS MF201M0-P●●

Hardware code

●● hardware code

Program code

P●● program code

Connection type

M Connector with screw terminals

Supply voltage

0 24 Vdc

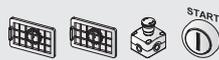
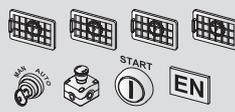
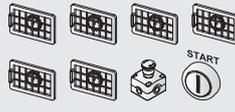
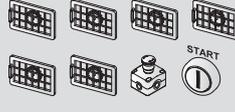
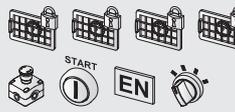
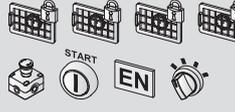

## Product list

Product code	Functions executed	Safety outputs	Signalling outputs	Page
<b>CS MF201M0-P1</b>	Monitoring of 2 guards in AND and 1 emergency stop with automatic start or manual monitored start. 	3 NO	4 PNP	307
<b>CS MF202M0-P2</b>	Monitoring of 4 guards in AND, 1 bypass selector, 1 emergency stop, automatic start or manual monitored start, general enabling signal. 	4 PNP	4 PNP	308
<b>CS MF202M0-P3</b>	Monitoring of 6 guards in AND (2NC contacts), 1 emergency stop, automatic start or manual monitored start. 	4 PNP	4 PNP	309
<b>CS MF202M0-P4</b>	Monitoring of 6 guards in AND (1NO+1NC contacts), 1 emergency stop, automatic start or manual monitored start. 	4 PNP	4 PNP	310
<b>CS MF202M0-P5</b>	Monitoring of 4 guards with independent outputs, 1 bypass selector, 1 emergency stop, automatic start or manual monitored start, general enabling signal. 	4 PNP	4 PNP	311
<b>CS MF202M0-P6</b>	Monitoring of 2 guards, 1 bypass selector, 1 emergency stop, automatic start or manual monitored start, general enabling signal. Three instantaneous outputs and one delayed output with selector switch with 4 times. Selectable On/Off delay. 	4 PNP	4 PNP	312
<b>CS MF202M0-P7</b>	Monitoring of 4 guards (AND linked) with switches with guard locking, operating principle "D", 1 emergency stop, monitored start. Two instantaneous outputs and two delayed outputs with selector switch with 4 times. 	4 PNP	4 PNP	313
<b>CS MF202M0-P8</b>	Monitoring of 4 guards in AND with switches with guard locking, operating principle "E", 1 emergency stop, monitored start. Two instantaneous outputs and two delayed outputs with selector switch with 4 times. 	4 PNP	4 PNP	314

## Legend



Movable guard monitoring



Start function



Time selector



Monitoring of a movable guard with lock



Bypass selector



Enabling input



Emergency stop



**Product code**  
CS MF201M0-P1

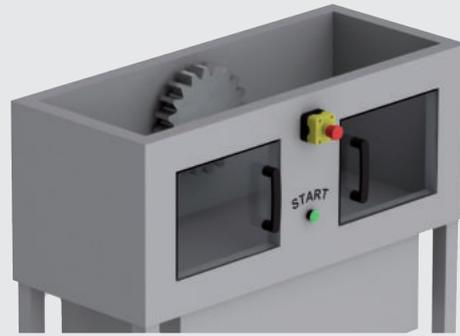

**Main functions**

- Monitoring of 2 guards
- Monitoring of 1 emergency stop
- Automatic start or monitored manual start

**Outputs**

- 3 NO safety outputs
- 4 PNP signalling outputs

Technical data: see CS MP201M0  
Dimensions, cable cross sections, terminal tightening torque: page 317, design C  
Internal block diagram: page 320  
Terminal layout: page 320

**Application program: P1**

The application program stored in the module executes one or more safety functions, as shown in the following block diagram:

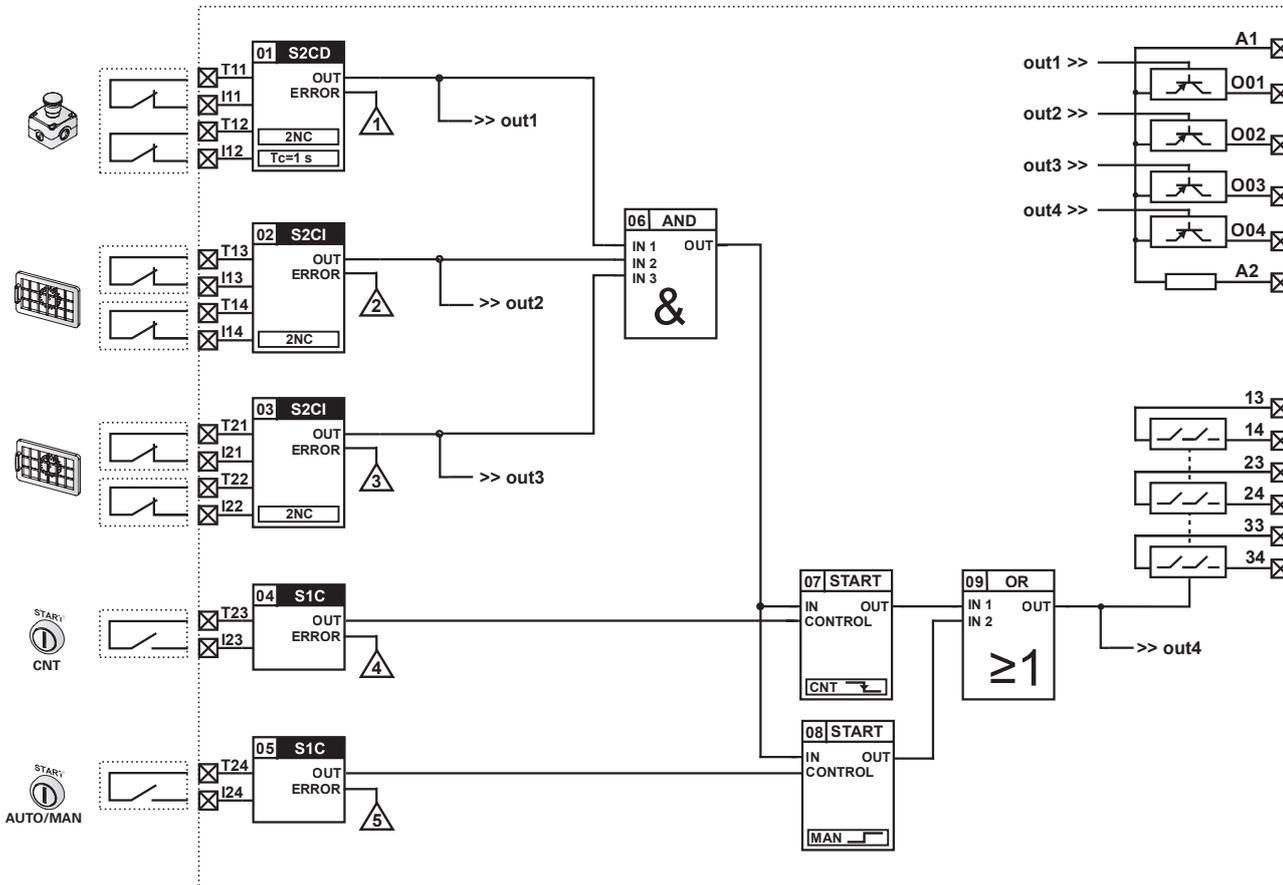



**Product code**  
CS MF202M0-P2



### Main functions

- Monitoring of 4 guards
- 1 bypass selector
- 1 emergency stop
- Automatic start or monitored manual start
- General enabling signal

### Outputs

- 4 PNP safety outputs
- 4 PNP signalling outputs

Technical data: see CS MP202M0  
Dimensions, cable cross sections, terminal tightening torque: page 317, design C  
Internal block diagram: page 320  
Terminal layout: page 320

### Application program: P2

The application program stored in the module executes one or more safety functions, as shown in the following block diagram:

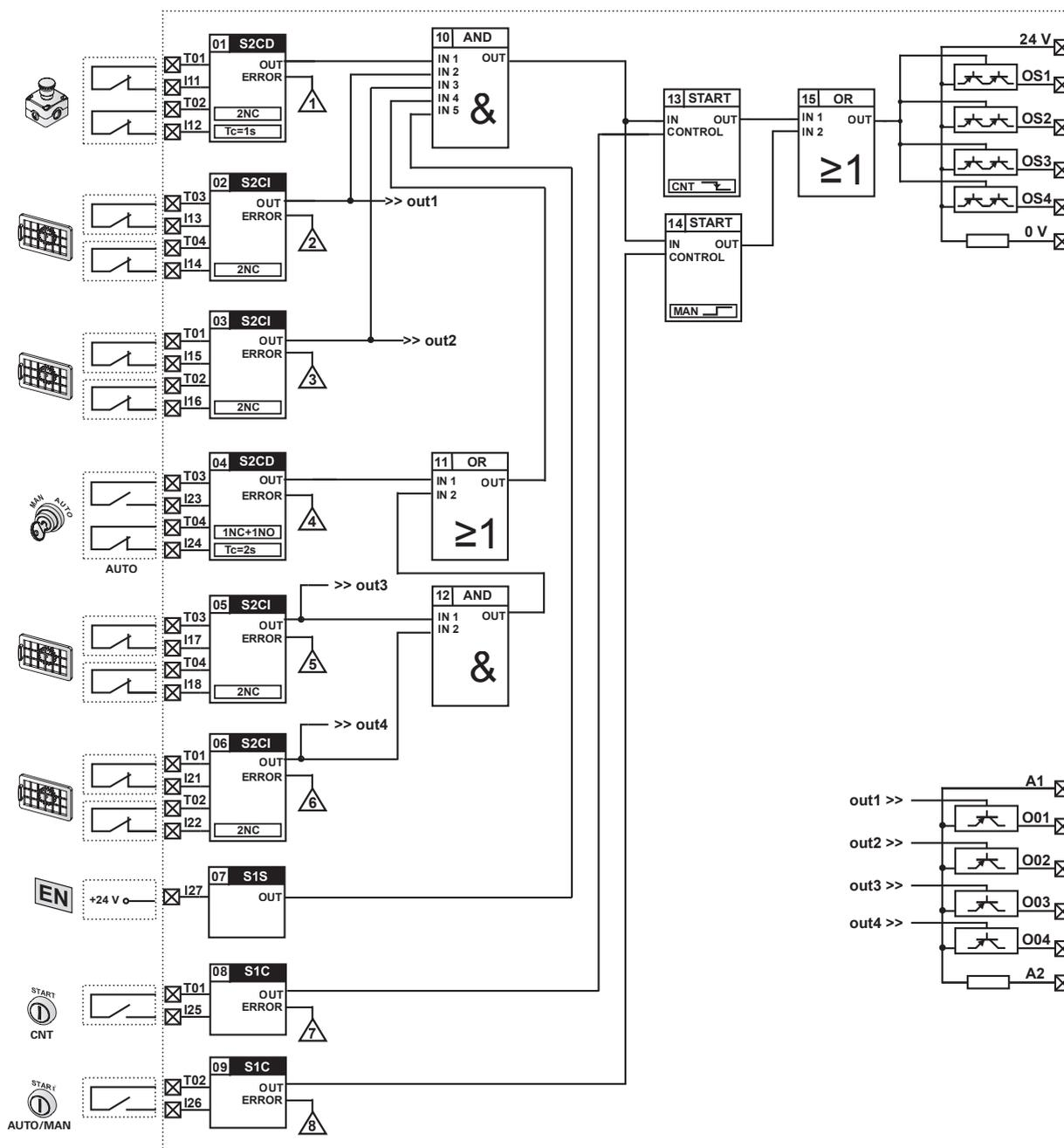



**Product code**  
CS MF202M0-P3

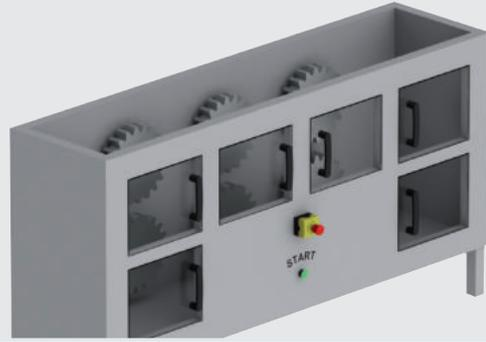

**Main functions**

- Monitoring of 6 guards (2NC contacts)
- 1 emergency stop
- Automatic start or monitored manual start

**Outputs**

- 4 PNP safety outputs
- 4 PNP signalling outputs

Technical data: see CS MP202M0

Dimensions, cable cross sections, terminal tightening torque: page 317, design C

Internal block diagram: page 320

Terminal layout: page 320

**Application program: P3**

The application program stored in the module executes one or more safety functions, as shown in the following block diagram:

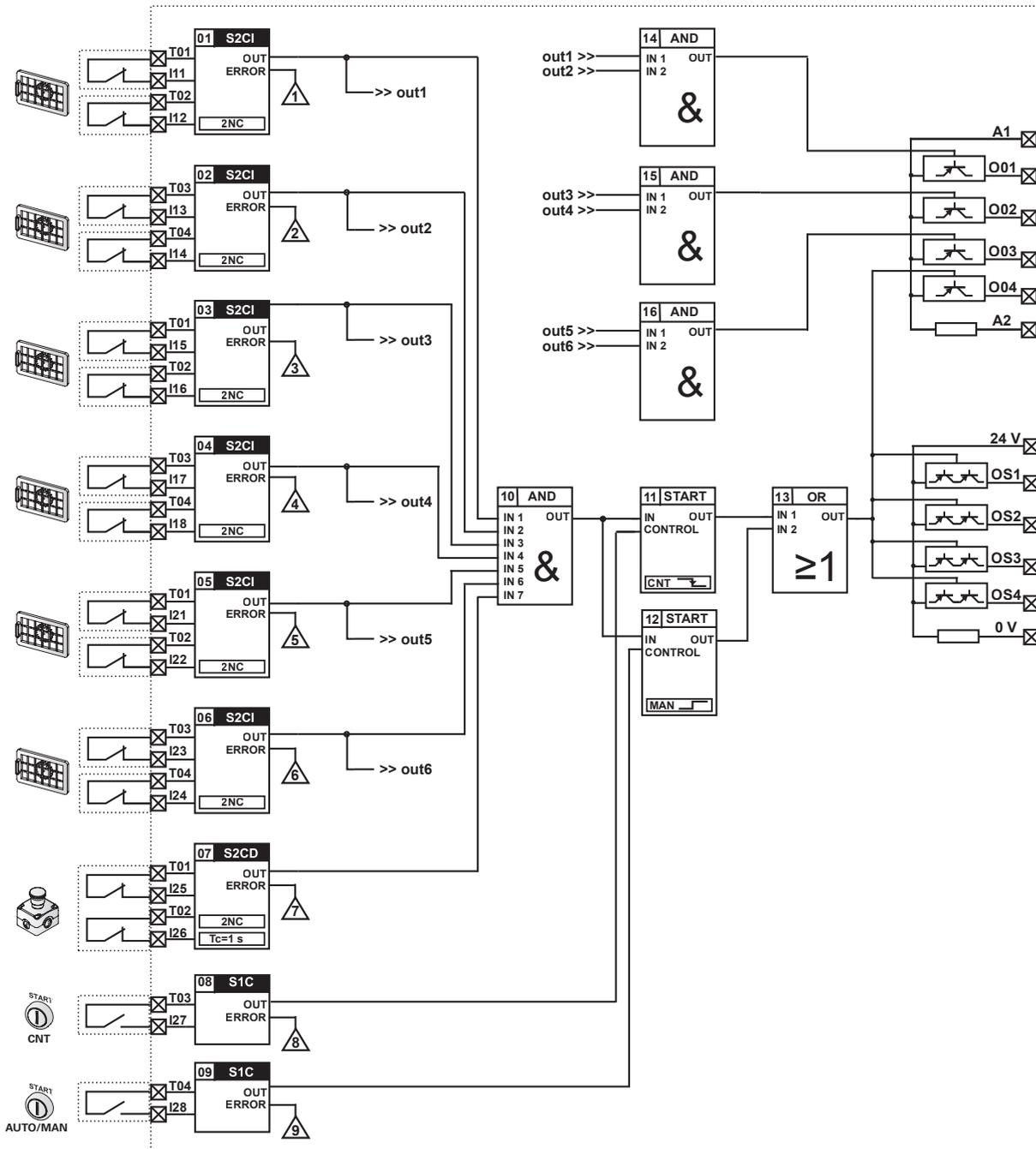



**Product code**  
CS MF202M0-P4

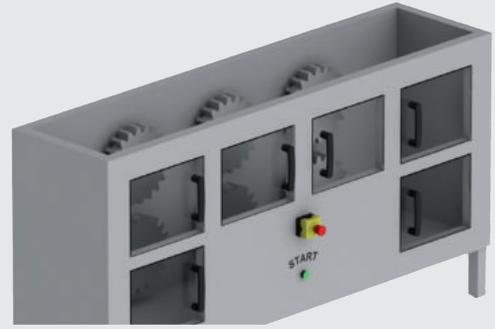

**Main functions**

- Monitoring of 6 guards (1NC+1NO contacts)
- 1 emergency stop
- Automatic start or monitored manual start

**Outputs**

- 4 PNP safety outputs
- 4 PNP signalling outputs

Technical data: see CS MP202M0  
Dimensions, cable cross sections, terminal tightening torque: page 317, design C  
Internal block diagram: page 320  
Terminal layout: page 320

**Application program: P4**

The application program stored in the module executes one or more safety functions, as shown in the following block diagram:

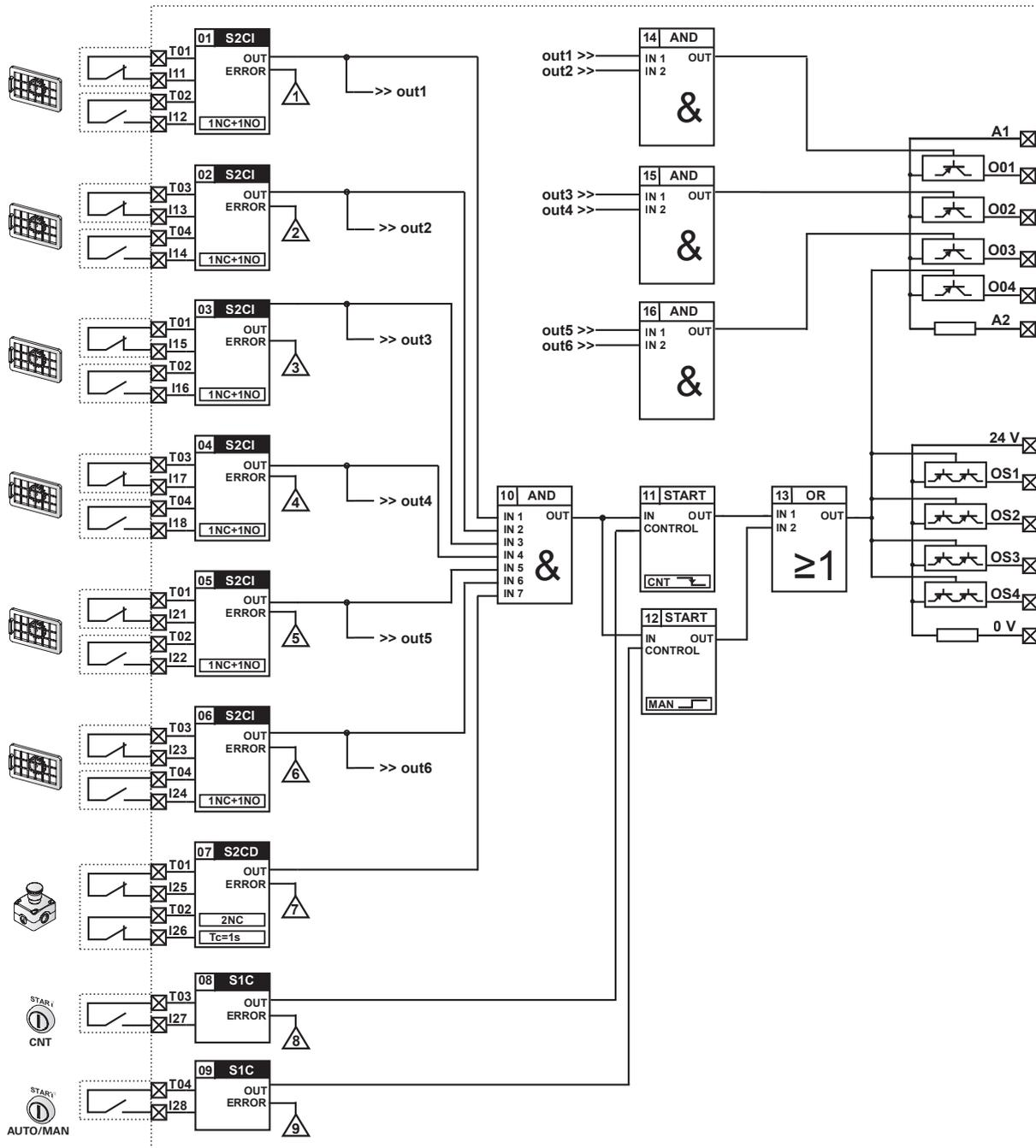



**Product code**  
CS MF202M0-P5



**Main functions**

- Monitoring of 4 guards with independent outputs
- 1 bypass selector
- 1 emergency stop
- Automatic start or monitored manual start
- General enabling signal

**Outputs**

- 4 PNP safety outputs
- 4 PNP signalling outputs

Technical data: see CS MP202M0  
Dimensions, cable cross sections, terminal tightening torque: page 317, design C  
Internal block diagram: page 320  
Terminal layout: page 320

**Application program: P5**

The application program stored in the module executes one or more safety functions, as shown in the following block diagram:

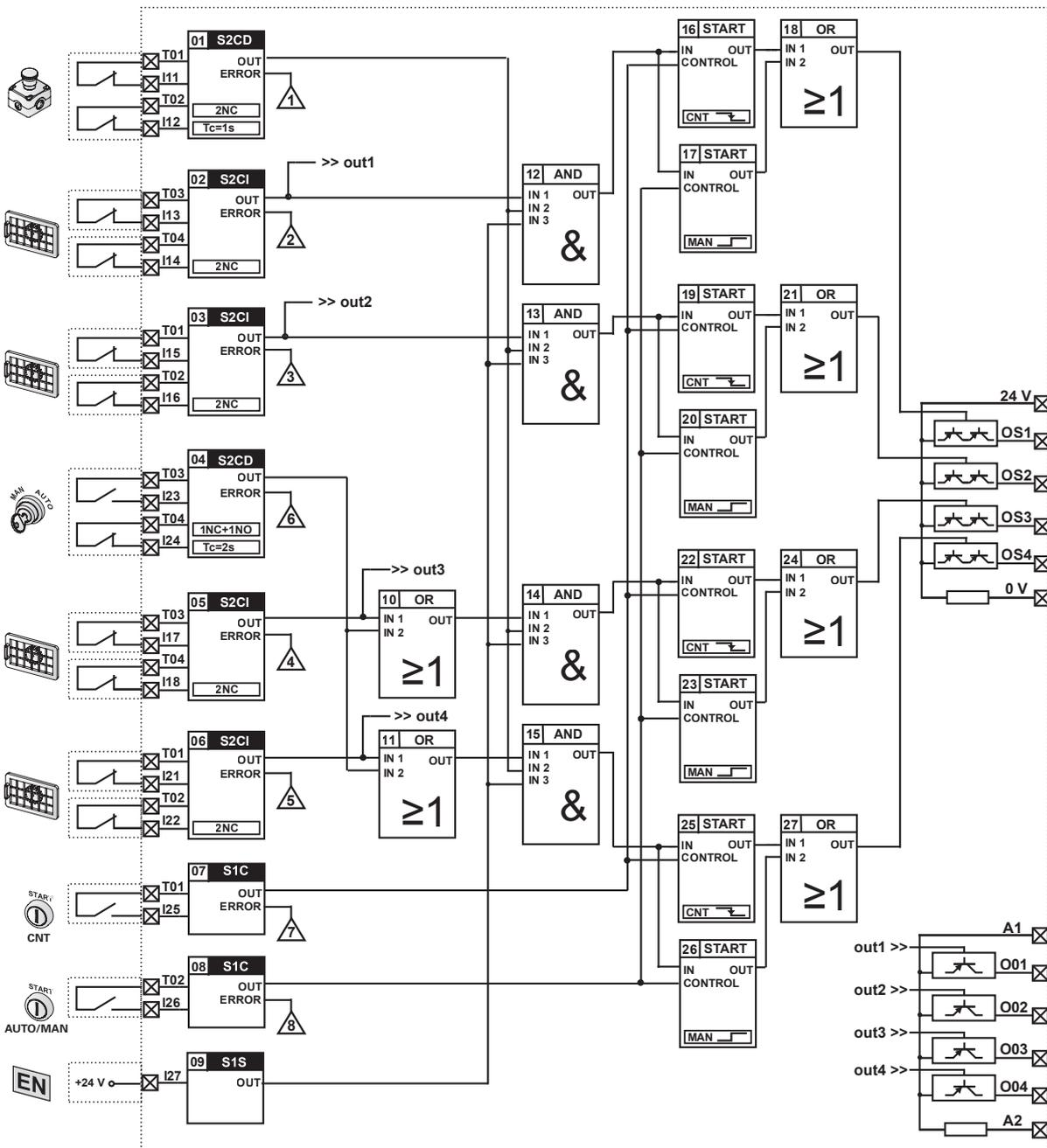





# CS MF202M0-P6 pre-programmed module



**Product code**  
CS MF202M0-P6



### Main functions

- Monitoring of 2 guards
- 1 bypass
- 1 emergency stop
- Automatic start or monitored manual start
- General enabling signal
- Selectable On/Off delay
- Selector switch with 4 times

### Outputs

- Three instantaneous outputs and one delayed PNP safety output
- 4 PNP signalling outputs

Technical data: see CS MP202M0  
 Dimensions, cable cross sections, terminal tightening torque: page 317, design C  
 Internal block diagram: page 320  
 Terminal layout: page 320

### Application program: P6

The application program stored in the module executes one or more safety functions, as shown in the following block diagram:

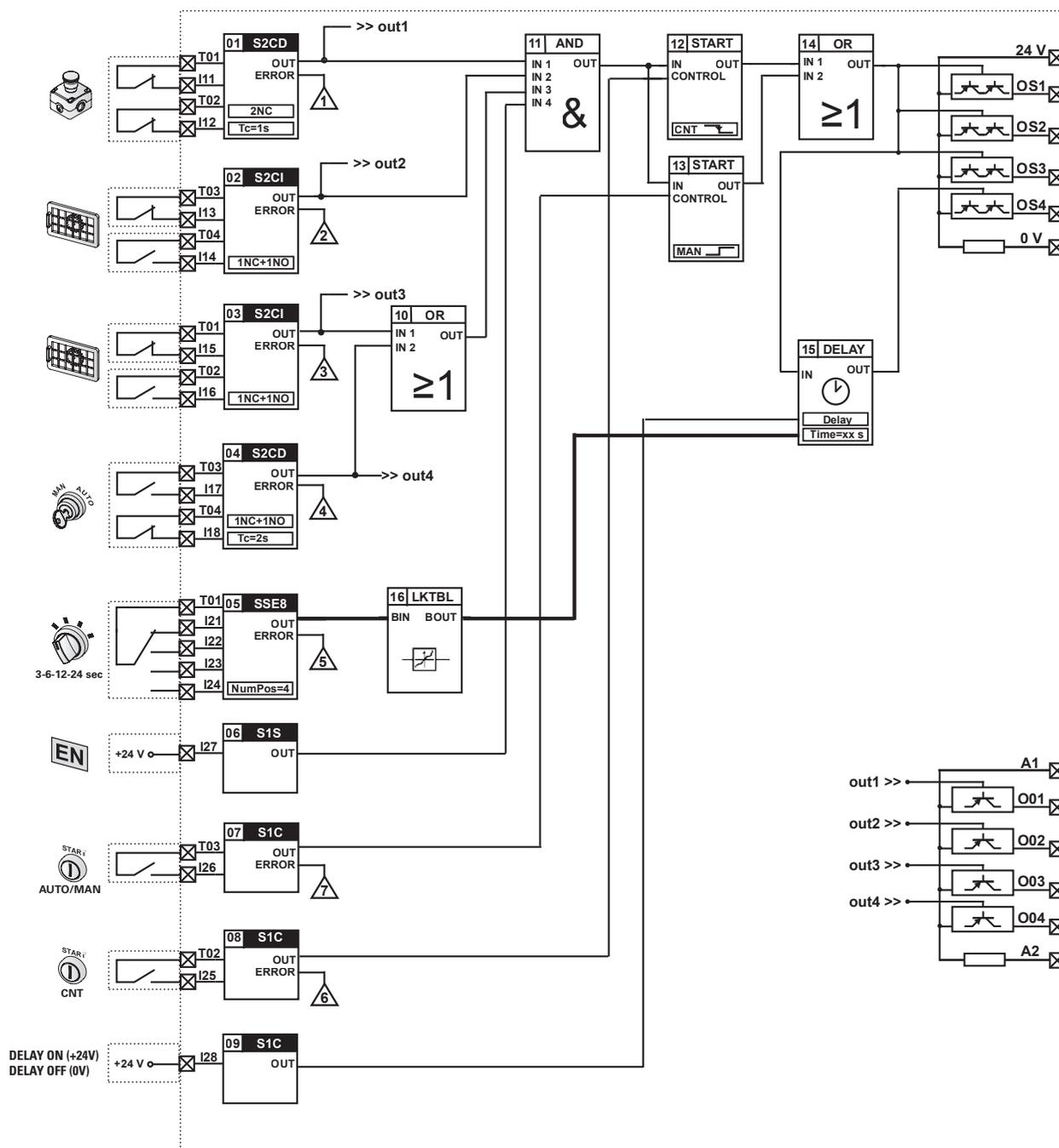



Product code  
CS MF202M0-P7

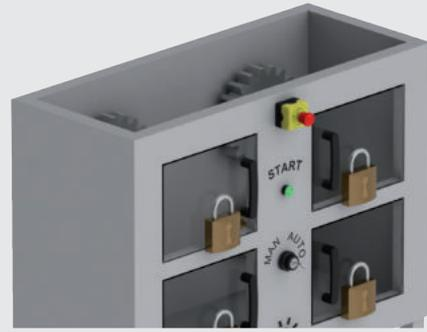

**Main functions**

- Monitoring of 4 guards with switches with guard locking, operating principle "D" (guard locked if solenoid is de-energised)
- 1 emergency stop
- Monitored start

**Outputs**

- 2 instantaneous outputs and 2 delayed PNP safety outputs with selector switch with 4 times
- 4 PNP signalling outputs
- OS4 output for door locking control

Technical data: see CS MP202M0  
Dimensions, cable cross sections, terminal tightening torque: page 317, design C  
Internal block diagram: page 320  
Terminal layout: page 320

**Application program: P7**

The application program stored in the module executes one or more safety functions, as shown in the following block diagram:

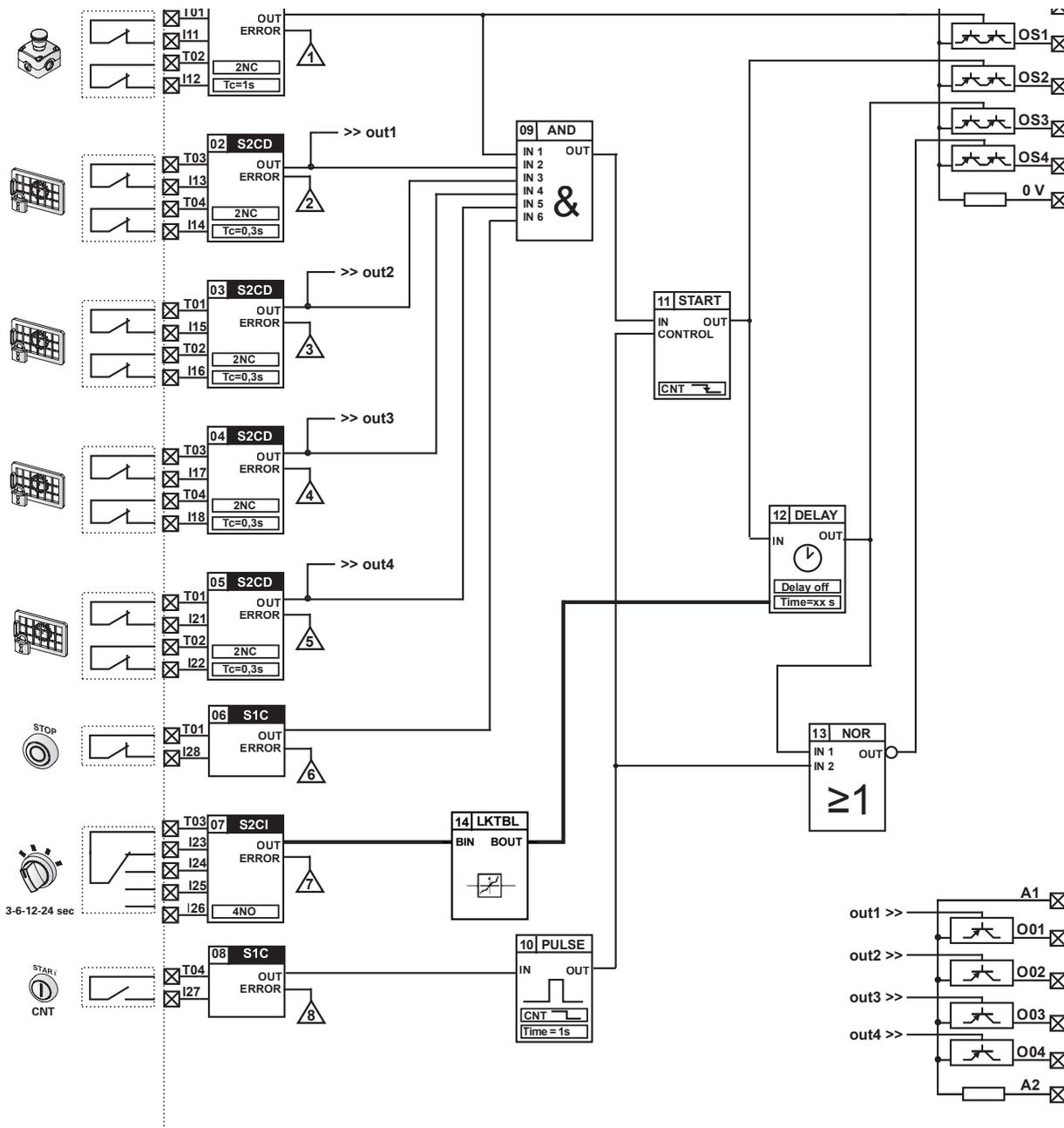



Product code  
CS MF202M0-P8

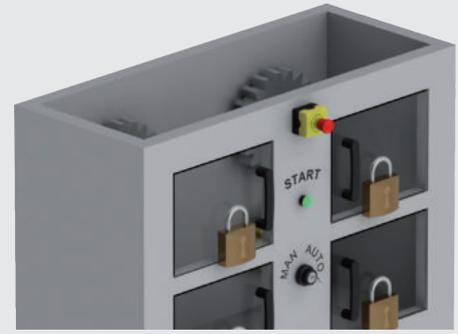

**Main functions**

- Monitoring of 4 guards with switches with guard locking, operating principle "E" (guard locked if solenoid is energised)
- 1 emergency stop
- Monitored start

**Outputs**

- 2 instantaneous outputs and 2 delayed PNP safety outputs with selector switch with 4 times
- 4 PNP signalling outputs
- OS4 output for door locking control

Technical data: see CS MP202M0  
Dimensions, cable cross sections, terminal tightening torque: page 317, design C  
Internal block diagram: page 320  
Terminal layout: page 320

**Application program: P8**

The application program stored in the module executes one or more safety functions, as shown in the following block diagram:

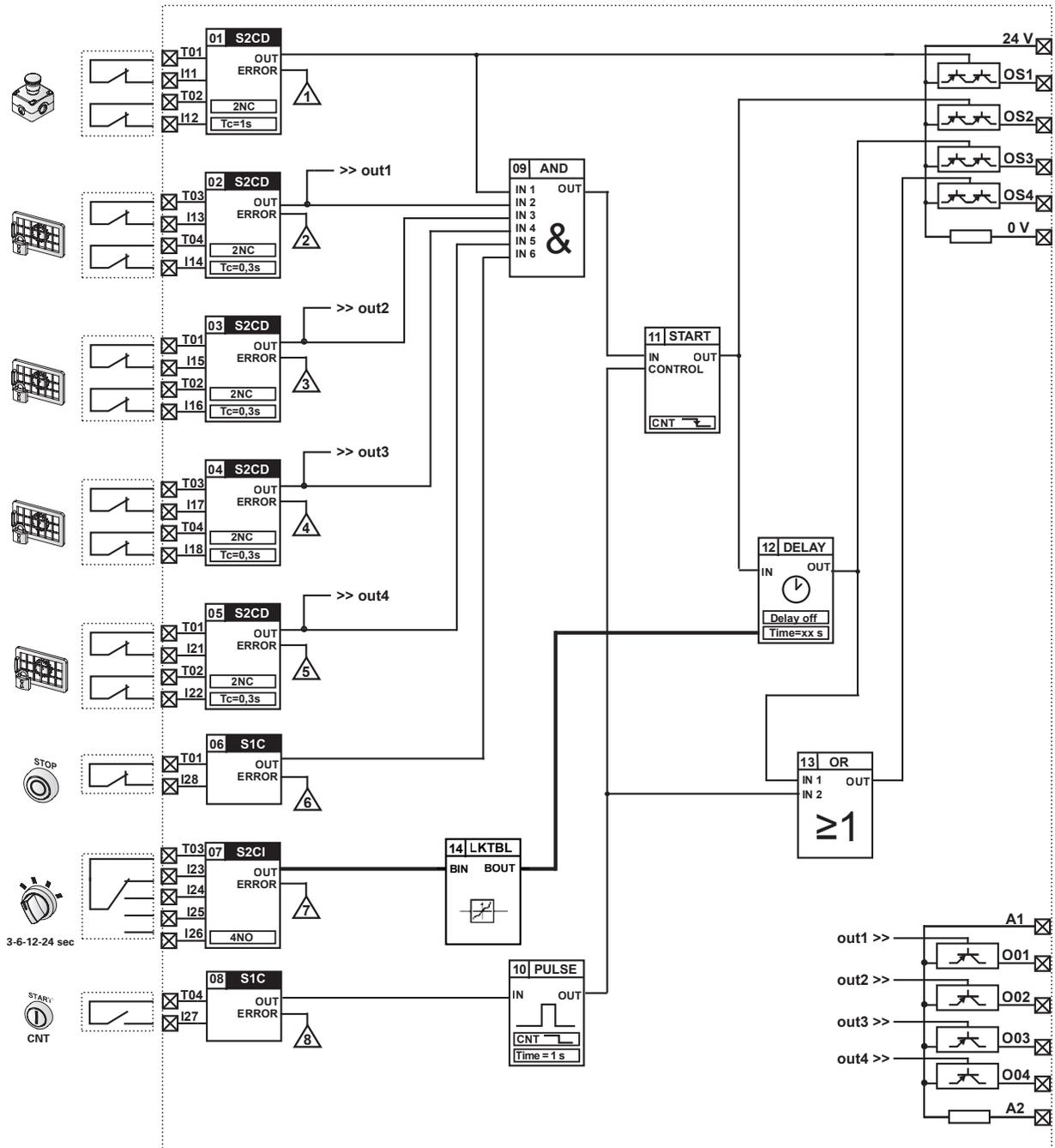

Notes: The positions of the contacts shown in the diagram are shown only as examples, and they refer to expected working conditions, with machinery in operation, guards closed, and safety devices not activated. For further explanations, please see documentation relating to each specific safety function (page 303).

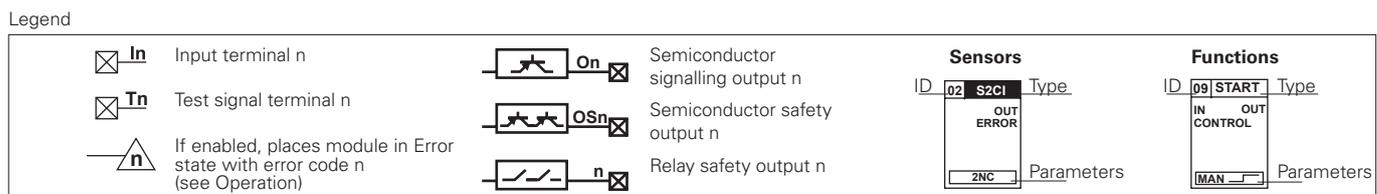

## Definitions

**Application program:** The internal software component of this module which is aimed at the application.  
**“Power On” state:** The device state, which lasts from the time it is switched on until the end of the internal controls.  
**“Run” state:** The device state on completion of the “Power-On” phase (if no errors have been detected) in which the Application program is run.  
**“Error” state:** The device state when a fault is detected. In this state, the module switches to the safe state, i.e., all safety outputs are open.  
**Fault:** A fault can be internal or external to the safety module. Internal faults are autonomously detected by the module thanks to its redundant and self-monitored structure. An external fault can be detected by the application program. It follows that the definition of external fault is strictly dependent on the application (see note A).

## Operation

When supplied with power, the module enters the Power-On state and runs an internal self-diagnosis. In this phase, the two processor LEDs (P1, P2) remain illuminated red for about 1 second. If the internal tests are completed without malfunction, the two LEDs are switched off, the module enters the Run state, and runs the application program. If the start tests are not passed, the module enters the Error state and the malfunction is indicated by the processor LEDs remaining illuminated red.  
 The green LEDs relating to the power supply and the module inputs are not controlled by processors, and they immediately begin indicating the states of the respective inputs/outputs.  
 When the module is in the RUN state, and no faults are detected, the two LEDs (P1, P2) remain switched off.  
 In the Run state, the module can detect faults external to the module, for example caused by short circuits, or invalid input states (see note A). Depending on the fault type detected, the application program may place the module in error state, to indicate the malfunction. In this case, the application program can communicate an error code by making the LEDs (P1, P2) flash in sequence.  
 During the Run state, simultaneously with application program execution, the module constantly runs a series of internal tests to check for correct hardware operation. If a malfunction is detected, the module state changes to Error.  
 Once in Error state, the module is placed in a safe condition, that is with all the safety outputs open; the application program is no longer evaluated, and neither are the system inputs. Furthermore, the semiconductor signalling outputs are left unaltered (changes in inputs do not affect them) at the value imposed by the application program before entering the error state. To reset the module, just switch it off for the required duration (see technical data) and then switch it on again.

Note A: A short circuit is not always a fault. For example, in the case of an ordinary push button for emergency stops equipped with two NC contacts, contact opening is the signal to be evaluated and a short circuit between the two contacts is a fault. In contrast, in the case of a safety mat with 4-wire technology, the opposite is true, i.e. a short circuit between the wires is the signal to be evaluated whereas wire interruption is a fault.

## Fault signalling

LED PWR	LED P1 and P2	Possible fault cause
Off	Off	No power supply, incorrect connections, power wires cut, external fuses broken. Module fault.
Green	Off	Normal operation.
Green	Red	Non-restorable fault. Recommended action: Send module for repair.
Green	Red x 1 Blue x 1	Restorable fault: Overcurrent on Tx or Ox outputs. Recommended action: Disconnect the semiconductor signalling outputs (Ox) and the test outputs (Tx) to check whether an external short circuit is present.
Green	Red x 1 Blue x 2	Restorable fault. Problem detected on OSx (short circuit towards earth or positive pole, or else short circuit between two OSx). Suggested action: Disconnect the safety outputs to check if there are any problems on the external connections of the OSx outputs.
Green	Red x 1 Blue x 3	Restorable fault. Module temperature outside the limits. Recommended action: Restore module temperature to within permissible limits.
Green	Blue x N	Module entered Error state at the request of the application program. Error code N. Typically due to incorrect input conditions (external short circuits, status not permitted). Recommended action: Disconnect the inputs to find any short circuits. Check the documentation supplied with the application program for further details.

**Quick description of the main safety functions (CS MF•••••)****SENSORS**

Sensor	<b>S1C</b>	Monitoring of one contact
Outputs	OUT	The OUT output is active when the input is closed and there is no error
	ERROR	The ERROR output is active in the case where an electrical malfunction is detected in the input signal
Parameters	None	
Examples	Start button; Stop button; Simple contact	

Sensor	<b>S1S</b>	Monitoring of one static signal
Outputs	OUT	The OUT output is active if 24 Vdc is applied to the input
Parameters	None	
Examples	Generic sensors with PNP output; Enabling signals	

Sensor	<b>S2CD</b>	Monitoring of two dependent contacts
Outputs	OUT	The OUT output is active when both inputs are in normal or safety state and there is no error
	ERROR	The ERROR output is active in the case where simultaneity times are not respected, or in the case where an electrical malfunction is detected at the input signals
Parameters	2NC / 1NO+1NC	Contact position in normal or safety state
	Tc	Max. time of simultaneity in seconds
Examples	Emergency stop button; Rope switch; Switch with two linked contacts; Mode selector with two settings, changeover; Two individual switches with a time dependency	

Sensor	<b>S2CI</b>	Monitoring of two independent contacts
Outputs	OUT	The OUT output is active when both inputs are in normal or safety state and there is no error
	ERROR	The ERROR output is active in the case where an electrical malfunction is detected in the input signals
Parameters	2NC / 1NO+1NC	Contact position in normal or safety state
Examples	Two switches; Magnetic sensor	

Sensor	<b>SSE8</b>	Mode selector with 2 to 8 positions
Outputs	OUT	The output gives a numerical value of 1 to 8 corresponding to the active input, 0 in case of error
	ERROR	The ERROR output is active if multiple inputs are active or if no input is active, or if an electrical failure is detected in the input signals
Parameters	NumPos	Number of input signals (2 to 8)
Examples	Mode selectors with a common contact and between 2 and 8 outputs	

**FUNCTIONS**

Function	AND	AND logical function
Outputs	OUT	The OUT output is only active if all IN input signals are present

Function	DELAY	Delayed process activation/deactivation
Outputs	OUT	The OUT output is activated if a signal is present at the IN input with a delay of Td (parameter type Don) If the signal at the IN input drops out, the OUT output is deactivated with a delay of Td (parameter type Doff)
	Parameters	Don / Doff Td
		Delay type, Don (delay on) on activation or Doff (delay-off) on cut-off Length of delay on activation or cut-off

Function	NOR	NOR logical function
Outputs	OUT	The OUT output is only active in the absence of all IN input signals

Function	OR	OR logical function
Outputs	OUT	The OUT output is only active if at least one IN input signal is present

Function	PULSE	Activation of a process for a short time
Outputs	OUT	The OUT output is activated on the IN signal falling edge and remains active for the time set by Tp
Parameters	Tp	Pulse duration

Function	START	Activation of a process
Outputs	OUT	The OUT output is activated by the edge (see parameters) of the CONTROL signal if the IN input signal is present. Thus, it remains active as long as the signal is present at IN
Parameters	MAN / CNT	MAN = activation on rising edge, CNT = activation on falling edge

Function	LKTBL	Lookup table; Conversion table between data of the same type
Outputs	BOUT	Converted data at output. Initial value = 0.
Parameters	Number of data	Number of data present in the table

## Disclaimer:

Subject to modifications without prior notice and errors excepted. The data given in this sheet are accurately checked and refer to typical mass production values. The device descriptions and its applications, the fields of application, the external control details, as well as information on installation and operation, are provided to the best of our knowledge. This does not in any way mean that the characteristics described may entail legal liabilities extending beyond the "General Terms of Sale", as stated in the Pizzato Elettrica general catalogue. The customers/user is required to read our information and recommendations as well as the pertinent technical provisions before using the products for his own purposes.

**Design A, housing thickness 22.5 mm**

**Connection data**

Terminal tightening torque:	0.5 ... 0.6 Nm
Cable cross section:	0.2...2.5 mm <sup>2</sup> 24...12 AWG

**Installation**

Snap-mounting on DIN rails

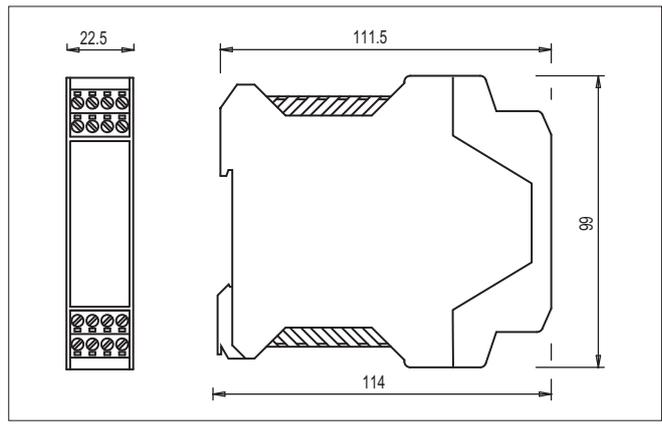

Connector with screw terminals

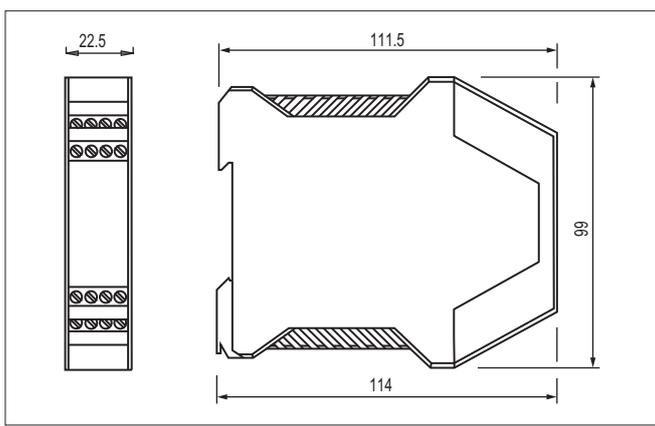

Screw terminals

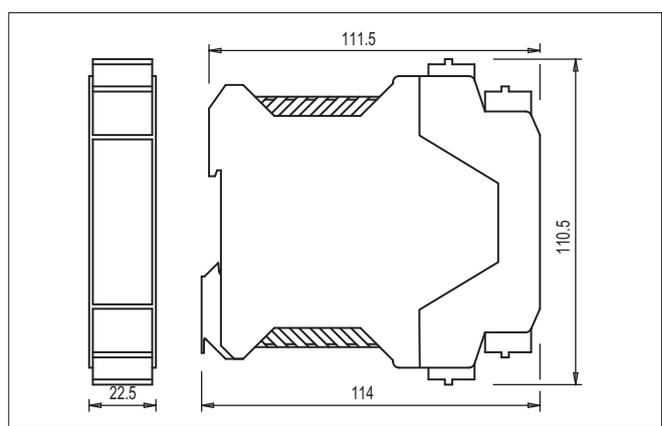

Connector with spring terminals

**Design B, housing thickness 22.5 mm**

**Connection data**

Terminal tightening torque:	0.5 ... 0.6 Nm
Cable cross section:	0.2...2.5 mm <sup>2</sup> 24...12 AWG

**Installation**

Snap-mounting on DIN rails

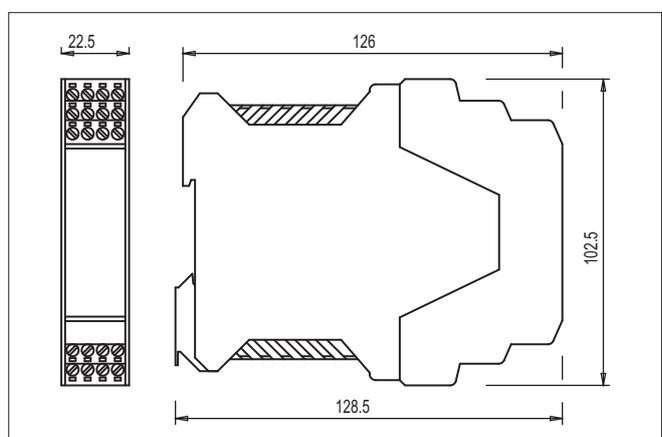

Connector with screw terminals

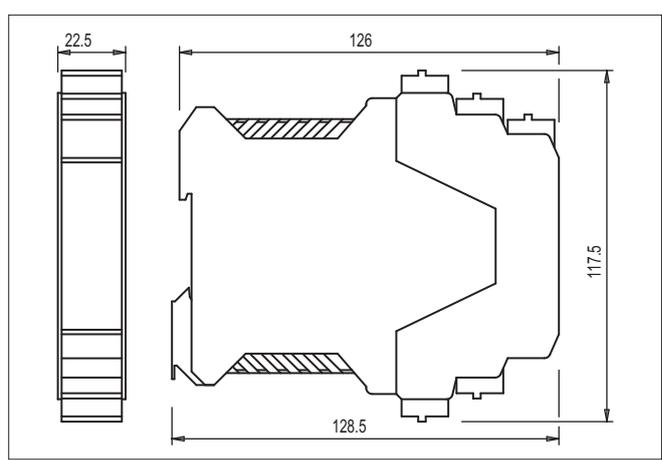

Connector with spring terminals

All values in the drawings are in mm



**Design C, housing thickness 45 mm**

**Connection data**  
 Terminal tightening torque: 0.5 ... 0.6 Nm  
 Cable cross section: 0.2...2.5 mm<sup>2</sup>  
 24...12 AWG

**Installation**  
 Snap-mounting on DIN rails

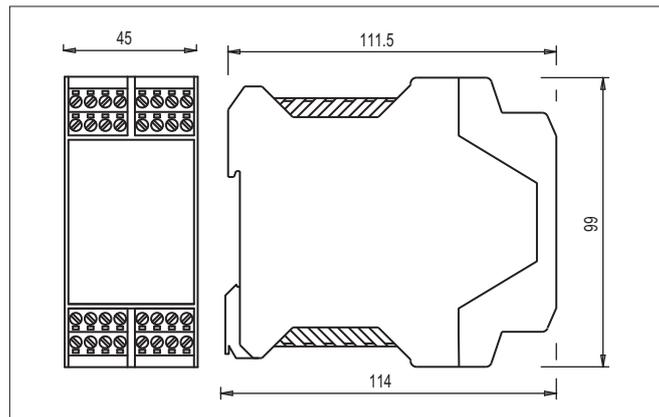

Connector with screw terminals

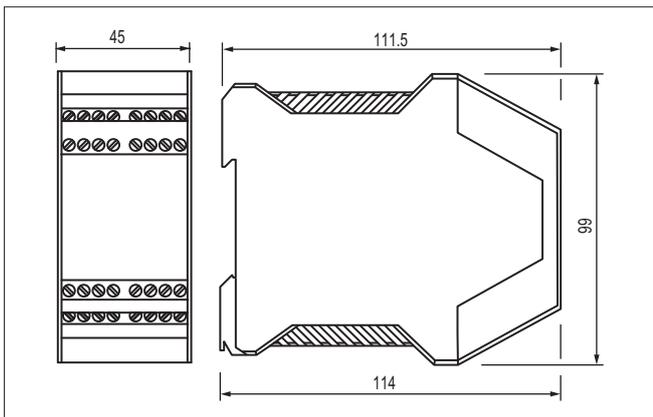

Screw terminals

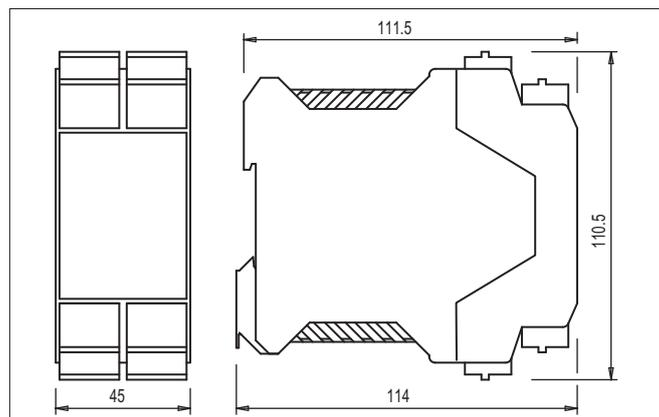

Connector with spring terminals

**Design D, housing thickness 22.5 mm**

**Connection data**  
 Terminal tightening torque: 0.5 ... 0.6 Nm  
 Cable cross section: 0.2...2.5 mm<sup>2</sup>  
 24...12 AWG

**Installation**  
 Snap-mounting on DIN rails

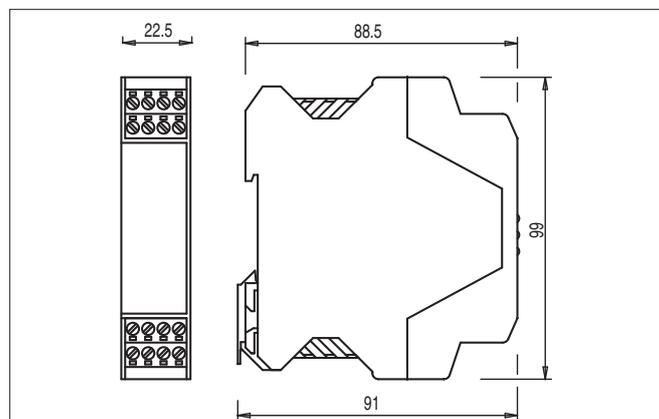

Connector with screw terminals

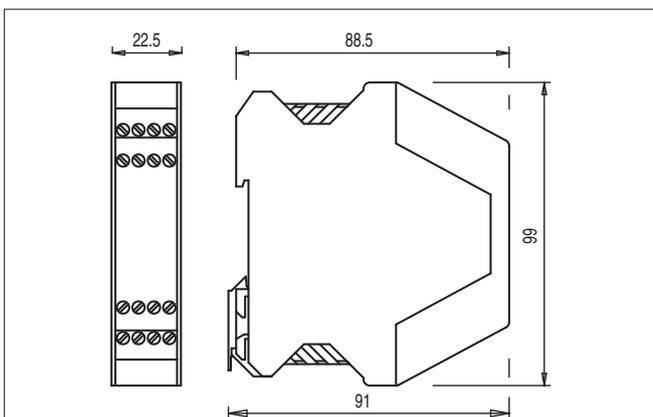

Screw terminals

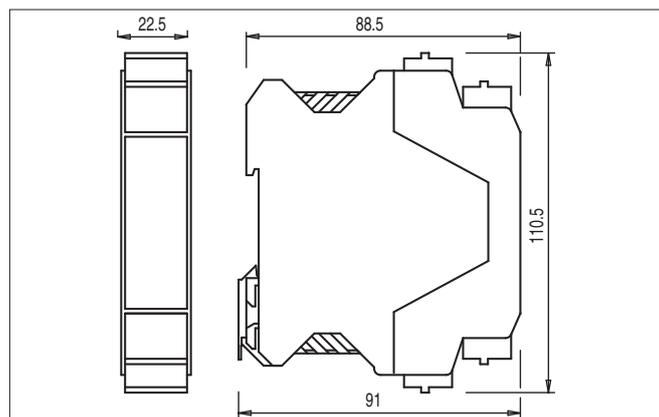

Connector with spring terminals

All values in the drawings are in mm

**Design E, housing thickness 67.5 mm**

**Connection data**

Terminal tightening torque:	0.5 ... 0.6 Nm
Cable cross section:	0.2...2.5 mm <sup>2</sup> 24...12 AWG

**Installation**

Snap-mounting on DIN rails

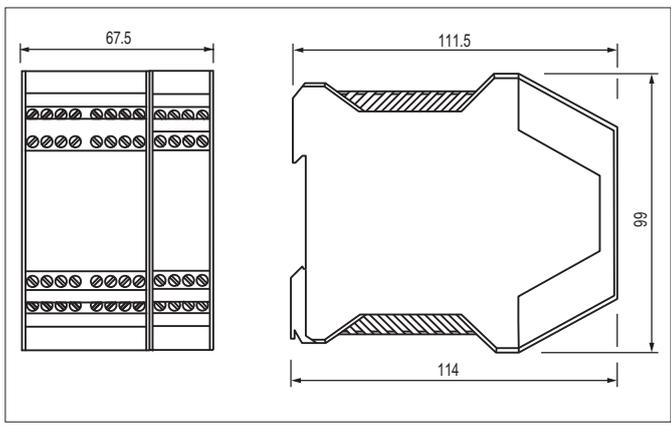

Screw terminals

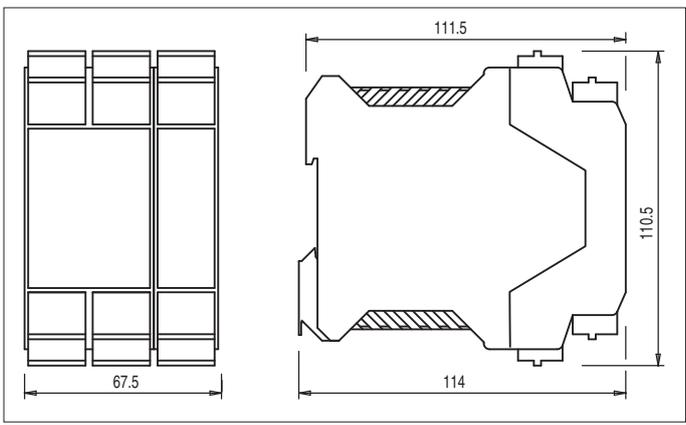

Connector with spring terminals

**Design F, housing thickness 90 mm**

**Connection data**

Terminal tightening torque:	0.5 ... 0.6 Nm
Cable cross section:	0.2...2.5 mm <sup>2</sup> 24...12 AWG

**Installation**

Snap-mounting on DIN rails

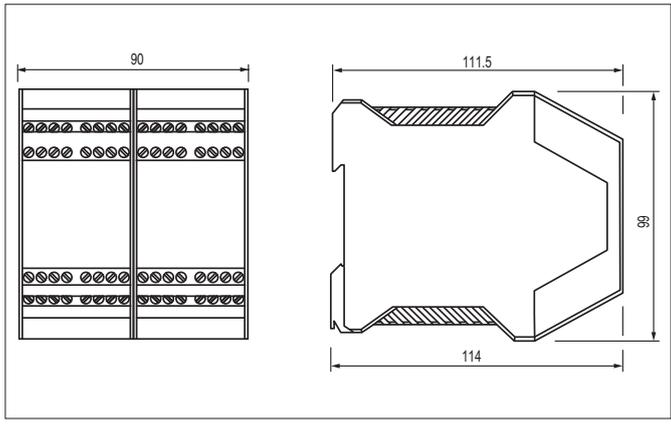

Screw terminals

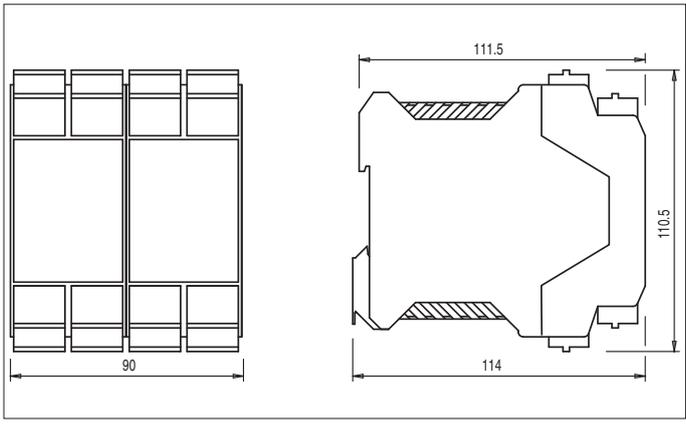

Connector with spring terminals

All values in the drawings are in mm





### Pin assignment CS MF series

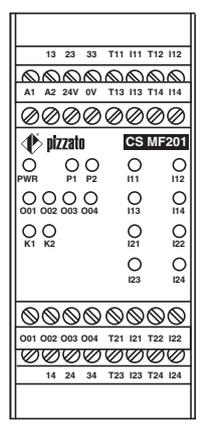

CS MF201

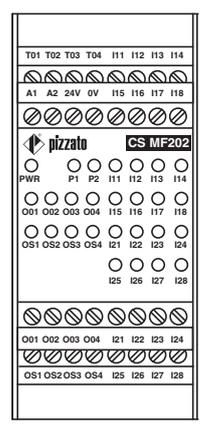

CS MF202

### CS MF series internal block diagram

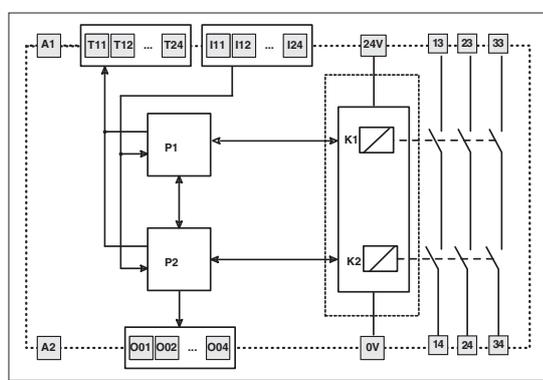

CS MF201

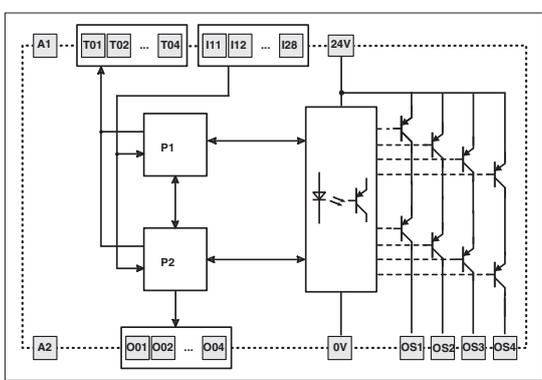

CS MF202

## M12 male connectors with cable



## Features:

- Polyurethane connector body
- Class 6 copper conductors acc. to IEC 60228 - mobile installation
- Gold-plated contacts
- Self-locking ring nut
- High flexibility cable with oil-resistant PVC sheath suitable to be used in drag chains, acc. to IEC 60332-1-2 and CEI 20-22II. With polyurethane sheath on request

Max. operating voltage:	250 Vac / 300 Vdc (5-pole) 30 Vac / 36 Vdc (8-pole)
Max. operating current:	4 A (5-pole) 2 A (8-pole)
Protection degree:	IP67 acc. to EN 60529 IP69K acc. to ISO 20653 (Protect the cables from direct high-pressure and high-temperature jets)
Ambient temperature:	-25°C ... +80°C for fixed installation -15°C ... +80°C for mobile installation
Wire cross-sections:	0.25 mm <sup>2</sup> (23 AWG)
Minimum bending radius:	> cable diameter x 15

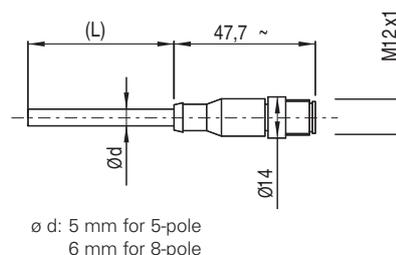

## Pin assignment

5 poles		8 poles	
Pin	Colour	Pin	Colour
1	Brown	1	White
2	White	2	Brown
3	Blue	3	Green
4	Black	4	Yellow
5	Grey	5	Grey
		6	Pink
		7	Blue
		8	Red

## Code structure

**Attention!** The feasibility of a code number does not mean the effective availability of a product. Please contact our sales office.

## VF CF5PD3M

No. of poles	5 poles	8 poles	Connection type	M M12x1
Cable sheath	P PVC (standard)	U PUR	Cable length (L)	3 3 metres (standard)
Connector type	D straight			5 5 metres
				0 10 metres
				Other lengths on request

## Stock items

VF CF5PD3M  
VF CF8PD3M

**Attention!** For items not in stock the minimum order quantity is 100 pcs.

**ATTENTION:** always disconnect the power supply before removing the connector. The connector is not suitable for separation of electrical loads.

All values in the drawings are in mm

→ The 2D and 3D files are available at [www.pizzato.com](http://www.pizzato.com)

**M12 female connectors with cable**



**Features:**

- Polyurethane connector body
- Class 6 copper conductors acc. to IEC 60228 - mobile installation
- Gold-plated contacts
- Self-locking ring nut
- High flexibility cable with PVC sheath suitable to be used in drag chains, acc. to IEC 60332-3 and CEI 20-22II. With polyurethane sheath on request

Max. operating voltage:	250 Vac / 300 Vdc (4/5-pole) 30 Vac / 36 Vdc (8/12-pole)
Max. operating current:	4 A (4-5 poles) 2 A (8-pole) 1.5 A (12-pole)
Protection degree:	IP67 acc. to EN 60529 IP69K acc. to ISO 20653 <small>(Protect the cables from direct high-pressure and high-temperature jets)</small>
Ambient temperature:	-25°C ... +80°C for fixed installation -15°C ... +80°C for mobile installation
Wire cross-sections:	0.34 mm <sup>2</sup> (22 AWG) for 4-pole 0.25 mm <sup>2</sup> (23 AWG) for 5/8-pole 0.14 mm <sup>2</sup> (26 AWG) for 12-pole
Minimum bending radius:	> cable diameter x 15

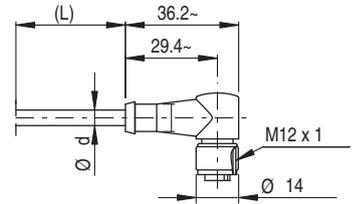
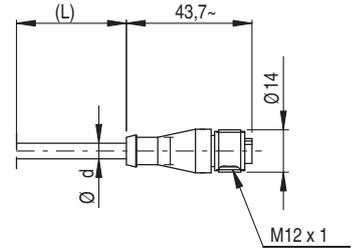

Ø d: 5 mm for 4 and 5-pole  
6 mm for 8 and 12 poles

**Pin assignment**

4 poles		5 poles		8 poles		12 poles	
Pin	Colour	Pin	Colour	Pin	Colour	Pin	Colour
1	Brown	1	Brown	1	White	1	Brown
2	White	2	White	2	Brown	2	Blue
3	Blue	3	Blue	3	Green	3	White
4	Black	4	Black	4	Yellow	4	Green
		5	Grey	5	Grey	5	Pink
				6	Pink	6	Yellow
				7	Blue	7	Black
				8	Red	8	Grey
						9	Red
						10	Purple
						11	Grey-Pink
						12	Red-Blue

**Code structure**

**Attention!** The feasibility of a code number does not mean the effective availability of a product. Please contact our sales office.

**VF CA4PD3M**

<b>No. of poles</b>	<b>4</b> 4 poles	<b>5</b> 5 poles	<b>8</b> 8 poles	<b>12</b> 12 poles
<b>Cable sheath</b>	<b>P</b> PVC (standard)	<b>U</b> PUR		
<b>Connector type</b>	<b>D</b> straight (standard)	<b>G</b> angled		
<b>Connection type</b>	<b>M</b> M12x1			
<b>Cable length (L)</b>	<b>1</b> 1 metre	<b>2</b> 2 metres	<b>3</b> 3 metres (standard)	<b>4</b> 4 metres
			<b>5</b> 5 metres (standard)	<b>0</b> 10 metres (standard)
				Other lengths on request

**Stock items**

- VF CA4PD3M
- VF CA4PD5M
- VF CA4PD0M
- VF CA5PD3M
- VF CA5PD5M
- VF CA5PD0M
- VF CA8PD5M
- VF CA8PD0M
- VF CA12PD5M
- VF CA12PD0M

**Attention!** For items not in stock the minimum order quantity is 100 pcs.

**ATTENTION:** always disconnect the power supply before removing the connector. The connector is not suitable for separation of electrical loads.

All values in the drawings are in mm

→ The 2D and 3D files are available at [www.pizzato.com](http://www.pizzato.com)

## M12 male connectors



## Features:

These standard M12 male connectors are ready for the installation on the switches.

Their wires have the right length for the connection to the contact blocks and are provided with wire-end sleeves. On request they can be delivered already wired to the switch. The connectors are used where a very short machine down time is required (e.g. in big plants). The connector-provided switch can be replaced very quickly with an identical one with no chance of incorrect wiring.

Max. operating voltage:	250 Vac / 300 Vdc (4/5-pole) 30 Vac / 36 Vdc (8/12-pole)
Max. operating current:	4 A (4/5-pole) 2 A (8-pole) 1.5 A (12-pole)
Protection degree:	IP67 acc. to EN 60529 IP69K acc. to ISO 20653
Ambient temperature:	-25°C ... +80°C
Tightening torque:	1 ... 1.5 Nm
Wire cross-sections:	0.5 mm <sup>2</sup> (20 AWG) for 4/5-pole 0.25 mm <sup>2</sup> (23 AWG) for 8-pole 0.14 mm <sup>2</sup> (26 AWG) for 12-pole
Contact type:	gold-plated

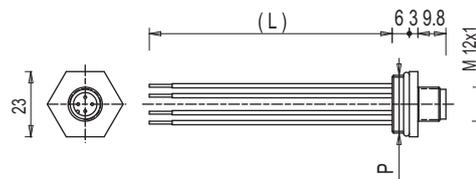

## Pin assignment

4 poles		5 poles		8 poles		12 poles	
Pin	Colour	Pin	Colour	Pin	Colour	Pin	Colour
1	Brown	1	Brown	1	White	1	Brown
2	White	2	White	2	Brown	2	Blue
3	Blue	3	Blue	3	Green	3	White
4	Black	4	Black	4	Yellow	4	Green
		5	Grey	5	Grey	5	Pink
				6	Pink	6	Yellow
				7	Blue	7	Black
				8	Red	8	Grey
						9	Red
						10	Purple
						11	Grey-Pink
						12	Red-Blue

## Code structure

**Attention!** The feasibility of a code number does not mean the effective availability of a product. Please contact our sales office.

article		options	
<b>VF CNM5MM-L100</b>			
<b>Body material</b>		<b>Wire length (L)</b>	
<b>M</b> metal		8.5 cm (standard)	
<b>P</b> plastic		<b>L16</b> 16 cm	
		<b>L100</b> 100 cm	
		<b>L200</b> 200 cm	
<b>No. of poles</b>		<b>Connection type</b>	
<b>4</b> 4 poles		<b>M</b> M12x1	
<b>5</b> 5 poles		<b>Connector thread (P)</b>	
<b>8</b> 8 poles		<b>M</b> M20 x 1.5 (standard)	
<b>12</b> 12 poles		<b>P</b> PG 13.5	

## Stock items

VF CNP4MM
VF CNP4PM
VF CNP5MM
VF CNP5PM
VF CNP8MM
VF CNM4MM
VF CNM4PM
VF CNM5MM
VF CNM5PM
VF CNM8MM
VF CNM8PM
VF CNM12MM-L16

**ATTENTION:** always disconnect the power supply before removing the connector. The connector is not suitable for separation of electrical loads.

**Note:** the 12-pole connector is only available in metal with M20x1.5 thread and 16 cm wires.

All values in the drawings are in mm

→ The 2D and 3D files are available at [www.pizzato.com](http://www.pizzato.com)

## Field wireable M12 female connectors



### Features:

- Technopolymer connector body
- Gold-plated contacts
- Screw terminals for cable screw fittings

Max. operating voltage:	250 Vac/dc (4 and 5-pole) 30 Vac/dc (8-pole)
Max. operating current:	4 A (4 and 5-pole) 2 A (8-pole)
Protection degree:	IP67 acc. to EN 60529
Ambient temperature:	-25°C ... +85°C
Wire cross-sections:	0.25 mm <sup>2</sup> (23 AWG) ... 0.5 mm <sup>2</sup> (20 AWG)

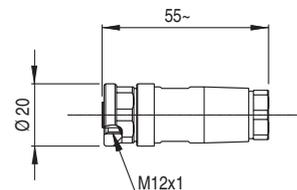

Article	Description	no. of poles
VF CBMP4DM04	Field wireable M12 female connector, straight, for Ø 4 ... 6.5 mm multipolar cables	4
VF CBMP5DM04	Field wireable M12 female connector, straight, for Ø 4 ... 6.5 mm multipolar cables	5
VF CBMP8DM04	Field wireable M12 female connector, straight, for Ø 4 ... Ø 7 mm multipolar cables	8

## Field wireable M12 male connectors



### Features:

- Technopolymer connector body
- Gold-plated contacts
- Screw terminals for cable screw fittings

Max. operating voltage:	250 Vac/dc (5-pole) 30 Vac/dc (8-pole)
Max. operating current:	4 A (5-pole) 2 A (8-pole)
Protection degree:	IP67 acc. to EN 60529
Ambient temperature:	-25°C ... +85°C
Wire cross-sections:	0.25 mm <sup>2</sup> (23 AWG) ... 0.5 mm <sup>2</sup> (20 AWG)

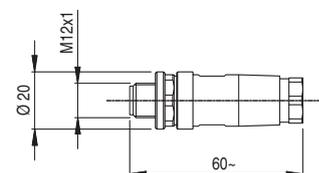

Article	Description	no. of poles
VF CCMP5DM04	Field wireable M12 male connector, straight, for Ø 4 ... Ø 6.5 mm multipolar cables	5
VF CCMP8DM04	Field wireable M12 male connector, straight, for Ø 4 ... Ø 7 mm multipolar cables	8

**ATTENTION:** always disconnect the power supply before removing the connector. The connector is not suitable for separation of electrical loads.

### Series connection with Y-shaped M12 connectors

To facilitate and simplify the series wiring of the safety devices, a variety of accessories designed specifically for this purpose are available. With the help of the proven M12 round connector, safety equipment of Category 4, SIL3 and PL e with up to 32 elements connected in series is possible. All of which is possible without the risk of connection errors and with a high IP67 protection degree.

The safety circuits consist of a 24 Vdc power supply unit, a number of extensions to the installed devices, Y connectors for branching out from the chain to each individual device and a terminating plug.

In addition to the power supply unit, a suitable safety module is used to assess the state of the safety outputs within the safety chain.

#### Devices suitable for series connection

The series may consist both of devices that are identical to one another (homogeneous series) or that belong to different series (mixed series).

The following Pizzato Elettrica devices may be connected in series using the Y connectors:

- ST series safety sensors with RFID technology: ST D•31•M•, ST D•71•M•.
- NG series safety switches with lock and RFID technology: NG •••••-K950, NG •••••-K951, NG •••••-K952.
- NS series safety switches with lock and RFID technology: NS •••••Q•.
- HX series safety hinge switches: HX BEE1••M•.

#### Electrical connection of the chain

Pin	Colour	Connection
1	Brown	A1 Supply input +24 Vdc
2	White	OS1 Safety output
3	Blue	A2 Supply input 0 V
4	Black	OS2 Safety output
5	Grey	I4 Solenoid activation input

Note: By activating/deactivating input I4, all switches of the NG and NS series in the chain simultaneously block/open all guards. Activation and deactivation of input I4 has no effect on the ST sensors and HX hinges in the chain.

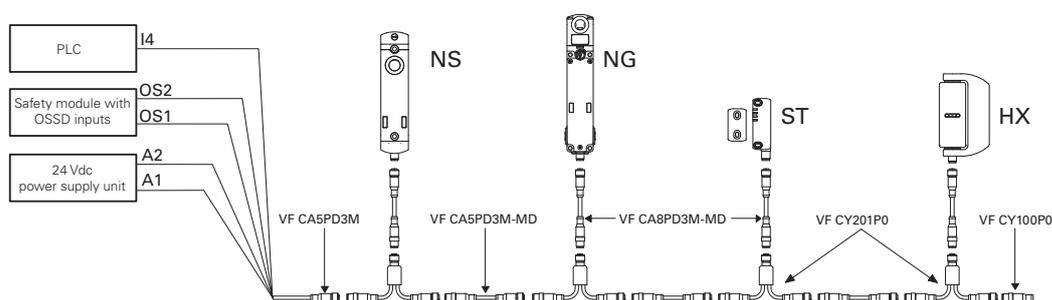

- **Attention!** For proper operation of the devices connected in series via cables or Y connectors, it is necessary to pay particular attention to the voltage drop that occurs in the circuit. Pay particular attention to the currents and cross-sections/lengths of the used cables to ensure that the supply voltage of the components at the end of the series connection remains within the specified limit values during effective operation.

### M12 extension cable



#### Features:

- Polyurethane connector body
- Class 6 copper conductors acc. to IEC 60228
- Gold-plated contacts
- Self-locking ring nut
- High flexibility cable with PVC sheath suitable to be used in drag chains, acc. to IEC 60332-3 and CEI 20-22II.

Max. operating voltage:	250 Vac / 300 Vdc (5-pole) 30 Vac / 36 Vdc (8-pole)
Max. operating current:	4 A (5-pole) 2 A (8-pole)
Protection degree:	IP67 acc. to EN 60529 IP69K acc. to ISO 2653 (Protect the cables from direct high-pressure and high-temperature jets)
Ambient temperature:	-25°C ... +80°C for fixed installation -15°C ... +80°C for mobile installation
Wire cross-sections:	0.5 mm <sup>2</sup> (20 AWG) (5-pole) 0.25 mm <sup>2</sup> (23 AWG) (8-pole)
Minimum bending radius:	> cable diameter x 15

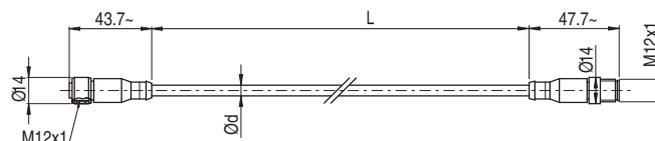

ø d: 6.4 mm for 5-pole  
6 mm for 8-pole

#### Pin assignment

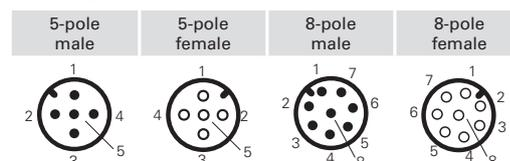

#### Stock items

VF CA5PD3M-MD  
VF CA5PD5M-MD  
VF CA5PD0M-MD  
VF CA8PD3M-MD  
VF CA8PD5M-MD

**Attention!** For items not in stock the minimum order quantity is 100 pcs

#### Code structure

### VF CA5PD3M-MD

No. of poles	5 5 poles	8 8 poles
Connection type	M M12x1	
Cable length (L)	3 3 metres (standard)	5 5 metres (standard)
		0 10 metres (standard)
	Other lengths on request	
Cable sheath	P PVC	
Connector type	D straight	

**ATTENTION:** always disconnect the power supply before removing the connector. The connector is not suitable for separation of electrical loads.

All values in the drawings are in mm

→ The 2D and 3D files are available at [www.pizzato.com](http://www.pizzato.com)

## M12 connectors, Y-shaped, for series connections



**Features:**

- Polyurethane connector body
- Class 6 copper conductors acc. to IEC 60228
- Gold-plated contacts
- Self-locking ring nut
- High flexibility cable with PVC sheath suitable to be used in drag chains, acc. to IEC 60332-3 and CEI 20-22II.

Max. operating voltage: 30 Vac / 36 Vdc  
 Max. operating current: 4 A (5-pole)  
 2 A (8-pole)  
 Protection degree: IP67 acc. to EN 60529  
 IP69K acc. to ISO 2653  
 (Protect the cables from direct high-pressure and high-temperature jets)  
 Ambient temperature: -25°C ... +80°C for fixed installation  
 -15°C ... +80°C for mobile installation  
 Wire cross-sections: 0.5 mm<sup>2</sup> (20 AWG)  
 Minimum bending radius: > cable diameter x 15

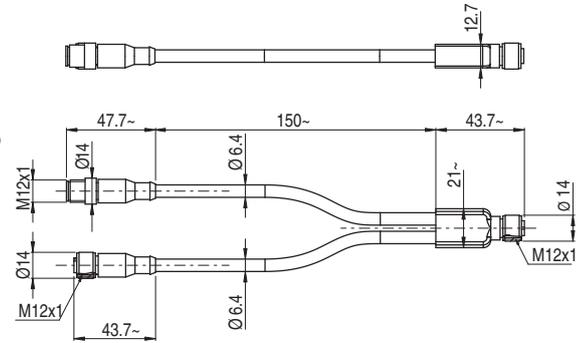

**Internal block diagram, Y-shaped connector**

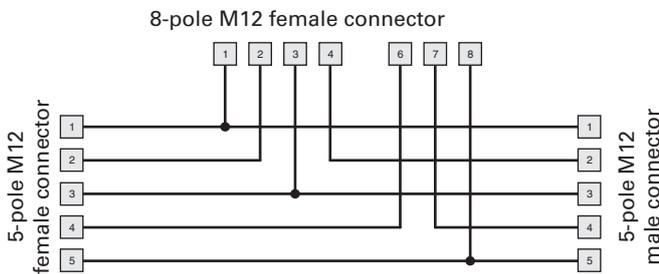

**Pin assignment**

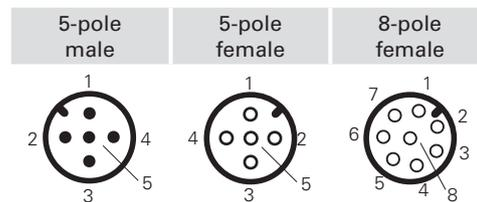

Article	Description
VF CY201P0	M12 connectors, Y-shaped, for series connections

**ATTENTION:** when used in safety applications, the Y-shaped connectors must be installed in a place that is not directly accessible, in order to avoid shocks or tampering.

## M12 terminating plugs for series connections



**Features:**

- Polyurethane connector body
- Gold-plated contacts
- Self-locking ring nut

Max. operating voltage: 250 Vac / 300 Vdc  
 Max. operating current: 4 A  
 Protection degree: IP67 acc. to EN 60529

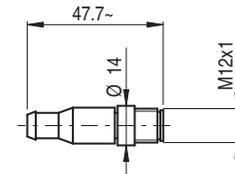

**Internal block diagram of the terminating plug**

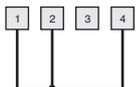

**Pin assignment**

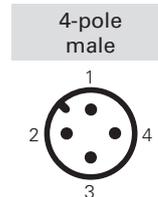

Article	Description
VF CY100P0	M12 terminating plugs for series connections, 4-pole

**ATTENTION:** always disconnect the power supply before removing the connector. The connector is not suitable for separation of electrical loads.

All values in the drawings are in mm

→ The 2D and 3D files are available at [www.pizzato.com](http://www.pizzato.com)

## M23 male connectors



## Features:

These standard M23 male connectors are ready for the installation on the switches with M20 cable input (e.g.: FG series and NG series).

Their wires have the right length for the connection to the contact blocks and are provided with wire-end sleeves. On request they can be delivered already wired to the switch. The connectors are used where a very short machine down time is required (e.g. in big plants). The connector-provided switch can be replaced very quickly with an identical one with no chance of incorrect wiring.

Max. operating voltage:	250 Vac (12-pole) 100 Vac (19-pole)
Max. operating current:	1.5 A
Protection degree:	IP67 acc. to EN 60529 IP69K acc. to ISO 20653
Ambient temperature:	-25°C ... +80°C
Tightening torque:	1 ... 1.5 Nm
Wire cross-section:	0.34 mm <sup>2</sup> (22 AWG)
Contact type:	gold-plated

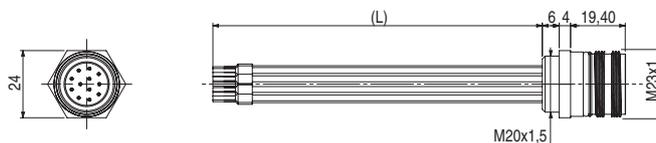

## Pin assignment

12 poles	19-pole
----------	---------

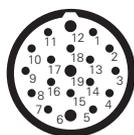
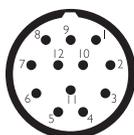

Pin	Colour	Pin	Colour	Pin	Colour
1	White	1	White	13	White-Green
2	Brown	2	Brown	14	Brown-Green
3	Green	3	Green	15	White-Yellow
4	Yellow	4	Yellow	16	Yellow-Brown
5	Grey	5	Grey	17	White-Grey
6	Pink	6	Pink	18	Grey-Brown
7	Blue	7	Blue	19	White-Pink
8	Red	8	Red		
9	Black	9	Black		
10	Purple	10	Purple		
11	Grey-Pink	11	Grey-Pink		
12	Red-Blue	12	Red-Blue		

## Code structure

**Attention!** The feasibility of a code number does not mean the effective availability of a product. Please contact our sales office.

## VF CNM12MT-L12

Body material	Wire length (L)
<b>M</b> metal	<b>L12</b> 12 cm
	<b>L16</b> 16 cm
No. of poles	
<b>12</b> 12 poles	
<b>19</b> 19-pole	

## Note

For applications with NG series switches, use connectors with L12 wire length.  
For applications with FG series switches, use connectors with L16 wire length.

**ATTENTION:** always disconnect the power supply before removing the connector. The connector is not suitable for separation of electrical loads.

All values in the drawings are in mm

→ The 2D and 3D files are available at [www.pizzato.com](http://www.pizzato.com)



## M23 female connectors with cable



### Features:

- Polyurethane connector body
- Class 5 copper conductors acc. to VDE 0295 (12-pole)
- Class 2 copper conductors acc. to VDE 0295 (19-pole)
- Gold-plated contacts
- Self-locking ring nut
- Cable with PVC sheath acc. to IEC 60332-3, CEI 20-22 II e CEI 20-35/1-2 (flame retarding)

Max. operating voltage:	250 Vac (12-pole) 100 Vac (19-pole)
Max. operating current:	4 A
Protection degree:	IP67 acc. to EN 60529 IP69K acc. to ISO 20653 (Protect the cables from direct high-pressure and high-temperature jets)
Ambient temperature:	-5°C ... +70°C
Wire cross-sections:	0.5 mm <sup>2</sup> (20 AWG) (12-pole) 0.34 mm <sup>2</sup> (22 AWG) (19-pole)
Minimum bending radius:	> cable diameter x 15

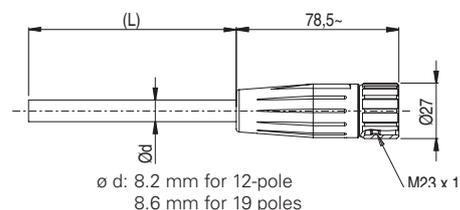

### Pin assignment

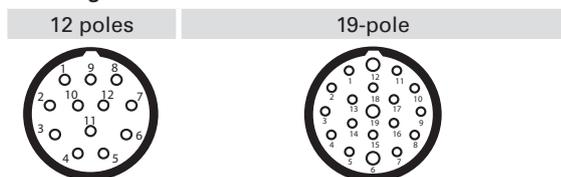

Pin	Colour	Pin	Colour	Pin	Colour
1	White	1	White	13	White-Green
2	Brown	2	Brown	14	Brown-Green
3	Green	3	Green	15	White-Yellow
4	Yellow	4	Yellow	16	Yellow-Brown
5	Grey	5	Grey	17	White-Grey
6	Pink	6	Pink	18	Grey-Brown
7	Blue	7	Blue	19	White-Pink
8	Red	8	Red		
9	Black	9	Black		
10	Purple	10	Purple		
11	Grey-Pink	11	Grey-Pink		
12	Red-Blue	12	Red-Blue		

## Code structure

**Attention!** The feasibility of a code number does not mean the effective availability of a product. Please contact our sales office.

# VF CA12PD20S

<b>No. of poles</b>		<b>Connection type</b>	
<b>12</b>	12 poles	<b>S</b>	M23x1
<b>19</b>	19-pole		
<b>Cable sheath</b>		<b>Cable length (L)</b>	
<b>P</b>	PVC	<b>0</b>	10 metres
		<b>20</b>	20 metres
		Other lengths on request	
<b>Connector type</b>			
<b>D</b>	straight		

### Stock items

VF CA12PD0S  
VF CA12PD20S  
VF CA19PD0S  
VF CA19PD20S

**Attention!** For items not in stock the minimum order quantity is 50 pcs.

**ATTENTION:** always disconnect the power supply before removing the connector. The connector is not suitable for separation of electrical loads.

All values in the drawings are in mm

→ The 2D and 3D files are available at [www.pizzato.com](http://www.pizzato.com)

## Field wireable M23 female connectors



## Features:

- Nickel-plated metal connector body
- Gold-plated contacts
- 12-pole or 19-pole versions

Max. operating voltage:	250 Vac (12-pole) 100 Vac (19-pole)
Max. operating current:	8 A
Protection degree:	IP67 acc. to EN 60529 IP69K acc. to ISO 20653
Ambient temperature:	-40°C ... +125°C
Tightening torque:	1 ... 1.5 Nm
Pollution degree:	3
Switching cycles:	> 1000

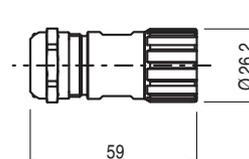

## Pin configuration

## 12 poles



clockwise numbering

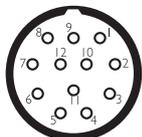

counterclockwise numbering

## 19-pole

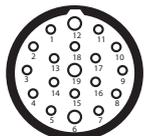

clockwise numbering



Article	Description
VF AC2205	Mounting key

**Note:** Article required for opening and wiring the connector

## Code structure

**Attention!** The feasibility of a code number does not mean the effective availability of a product. Please contact our sales office.

## VF CBSM12TC07

## Connection type

**S** M23x1

## Body material

**M** metal

## No. of poles

**12** 12 poles

**19** 19-pole

## Connector type

**T** clockwise numbering (standard)

**D** counterclockwise numbering

## Cable diameter

**07** Ø 7 ... 12 mm

## Pin connection type

**C** crimp connection (standard) 0.34 ... 1 mm<sup>2</sup>

**S** solder connection 0.34 ... 1 mm<sup>2</sup>

**Note:** Use appropriate crimp pliers for crimp connections (e.g., Knipex, article number 97 52 63).

 **Stock items**

VF CBSM12TC07

VF CBSM19TC07

VF CBSM12TS07

**ATTENTION:** always disconnect the power supply before removing the connector. The connector is not suitable for separation of electrical loads.

All values in the drawings are in mm

→ The 2D and 3D files are available at [www.pizzato.com](http://www.pizzato.com)

## M8 female connectors with cable



### Features:

- Polyurethane connector body
- Class 6 copper conductors acc. to IEC 60228
- Gold-plated contacts
- Self-locking ring nut
- High flexibility cable with PVC sheath suitable to be used in drag chains, acc. to IEC 60332-3 and CEI 20-22II. With polyurethane sheath on request.

Max. operating voltage:	60 Vac / 75 Vdc
Max. operating current:	4 A
Protection degree:	IP67 acc. to EN 60529 IP69K acc. to ISO 20653 (Protect the cables from direct high-pressure and high-temperature jets)
Ambient temperature:	-25°C ... +80°C for fixed installation -15°C ... +80°C for mobile installation
Wire cross-sections:	0.25 mm <sup>2</sup> (23 AWG)
Minimum bending radius:	> cable diameter x 15

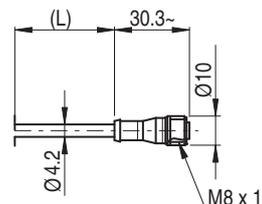

### Pin assignment

4 poles

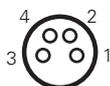

Pin	Colour
1	Brown
2	White
3	Blue
4	Black

## Code structure

**Attention!** The feasibility of a code number does not mean the effective availability of a product. Please contact our sales office.

# VF CA4PD3K

<b>No. of poles</b>		<b>Connection type</b>	
<b>4</b>	4 poles	<b>K</b>	M8x1
<b>Cable sheath</b>		<b>Cable length (L)</b>	
<b>P</b>	PVC (standard)	<b>1</b>	1 metre
<b>U</b>	PUR	<b>2</b>	2 metres
<b>Connector type</b>		<b>3</b>	3 metres (standard)
<b>D</b>	straight	<b>4</b>	4 metres
		<b>5</b>	5 metres (standard)
		...	
		<b>0</b>	10 metres

Other lengths on request

### Stock items

VF CA4PD3K  
VF CA4PD5K

### Attention!

For items not in stock the minimum order quantity is 100 pcs.

**ATTENTION:** always disconnect the power supply before removing the connector. The connector is not suitable for separation of electrical loads.

All values in the drawings are in mm

→ The 2D and 3D files are available at [www.pizzato.com](http://www.pizzato.com)

## Strain relief cable glands

Packs of **10 pcs.**

This particular design ensures high resistance to traction of the cable glands. All cable glands are also suitable for a wide range of cable diameters.

Suitable for circular cross-section cables only.

**Features:**

Body and ring material: technopolymer without halogen  
 Protection degree: IP67 acc. to EN 60529  
 Tightening torque: 3 ... 4 Nm (PG 13.5/M20)  
 2 ... 2.5 Nm (PG 11/M16)

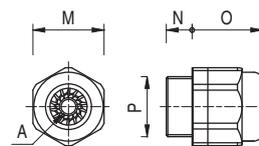

	Article	Description	A	⊙ <sub>M</sub>	N	O	P
Metric threads	VF PAM25C7N	M25x1.5 cable gland for one cable Ø 10 ... 17 mm	⊙	30	10	28	M25x1.5
	VF PAM20C6N	M20x1.5 cable gland for one cable Ø 6 ... 12 mm	⊙	24	9	24	M20x1.5
	VF PAM20C5N	M20x1.5 cable gland for one cable from Ø 5 ... 10 mm	⊙	24	9	24	M20x1.5
	VF PAM20C3N	M20x1.5 cable gland for one cable Ø 3 ... 7 mm	⊙	24	9	24	M20x1.5
	VF PAM16C5N	M16x1.5 cable gland for one cable Ø 5 ... 10 mm	⊙	22	7.5	23	M16x1.5
	VF PAM16C4N	M16x1.5 cable gland for one cable Ø 4 ... 8 mm	⊙	22	7.5	23	M16x1.5
	VF PAM16C3N	M16x1.5 cable gland for one cable Ø 3 ... 7 mm	⊙	22	7.5	23	M16x1.5
	VF PAM20CBN	M20x1.5 multi-hole cable gland for 2 cables Ø 3 ... 5 mm	⊙	24	9	23	M20x1.5
	VF PAM20CDN	M20x1.5 multi-hole cable gland for 3 cables Ø 1 ... 4 mm	⊙	24	9	23	M20x1.5
	VF PAM20CEN	M20x1.5 multi-hole cable gland for 3 cables Ø 3 ... 5 mm	⊙	24	9	23	M20x1.5
	VF PAM20CFN	M20x1.5 multi-hole cable gland for 4 cables Ø 1 ... 4 mm	⊙	22	9	23	M20x1.5
	PG threads	VF PAP13C6N	PG 13.5 cable gland for one cable from Ø 6 ... 12 mm	⊙	24	9	24
VF PAP13C5N		PG 13.5 cable gland for one cable from Ø 5 ... 10 mm	⊙	24	9	24	PG 13.5
VF PAP13C3N		PG 13.5 cable gland for one cable from Ø 3 ... 7 mm	⊙	24	9	24	PG 13.5
VF PAP11C5N		PG 11 cable gland for one cable from Ø 5 ... 10 mm	⊙	22	7.5	23	PG 11
VF PAP11C4N		PG 11 cable gland for one cable from Ø 4 ... 8 mm	⊙	22	7.5	23	PG 11
VF PAP11C3N		PG 11 cable gland for one cable from Ø 3 ... 7 mm	⊙	22	7.5	23	PG 11

## Thread adapters

Packs of **100 pcs.**

Thread adapters make it possible to fulfil requests for switches with a different thread to those generally found in stock. This means it is possible to offer customers a single product type with various threaded connections, while only having to stock the product itself and many kinds of adapters.

**Features:**

Body material: glass fibre reinforced technopolymer  
 Tightening torque: 3 ... 4 Nm

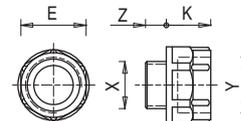

Article	Description	X	Y	Z	K	⊙ <sub>E</sub>
VF ADPG13-PG11	Adapter from PG 13.5 to PG 11	PG 13.5	PG 11	9	12	22
VF ADPG13-M20	Adapter from PG 13.5 to M20x1.5	PG 13.5	M20x1.5	9	14	24
VF ADPG13-1/2NPT	Adapter from PG 13.5 to 1/2 NPT	PG 13.5	1/2 NPT	9	14	24
VF ADPG11-1/2NPT	Adapter from PG 11 to 1/2 NPT	PG 11	1/2 NPT	7	14	24
VF ADPG11-PG13	Adapter from PG 11 to PG 13.5	PG 11	PG 13.5	7	14	24
VF ADM20-1/2NPT	Adapter from M20 x 1.5 to 1/2 NPT	M20 x 1.5	1/2 NPT	9	14	24

## Protection caps

Packs of **10 pcs.****Features:**

Body material: technopolymer, self-extinguishing  
 Protection degree: IP67 acc. to EN 60529  
 IP69K acc. to ISO 20653  
 Tightening torque: 1.2 ... 1.6 Nm  
 Cross-recessed screw: PH3

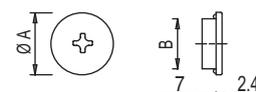

Article	Description	A	B
VF PTM20	Protection cap M20x1.5	24	M20x1.5
VF PTG13.5	Protection cap PG13.5	24	PG 13.5

## Threaded nuts

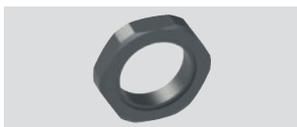
Packs of **10 pcs.**

**Features:**  
Tightening torque: 1.2 ... 2 Nm

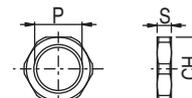

	Article	Description	S	CH	P
Plastic	VF DFPM25	M25x1.5 threaded technopolymer nut	6	32	M25x1.5
	VF DFPM20	M20x1.5 threaded technopolymer nut	6	27	M20x1.5
	VF DFPM16	M16x1.5 threaded technopolymer nut	5	22	M16x1.5
	VF DFPP13	PG13.5 threaded technopolymer nut	6	27	PG 13.5
Metal	VF DFMM20	M20x1.5 threaded nut in nickel-plated brass	3	23	M20x1.5

## Chock plugs

Packs of **100 pcs.**

**Features:**  
Body material: technopolymer  
Protection degree: IP54 acc. to EN 60529  
Tightening torque: 0.8 ... 1 Nm

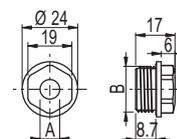

Notes: Use a socket wrench for tightening.

Article	Description	A	B
VF PFM20C8N	Chock plug for one cable Ø 8 ... 12 mm, threaded, M20x1.5	7.5	M20x1.5
VF PFM20C4N	Chock plug for one cable Ø 4 ... 8 mm, threaded, M20x1.5	3.5	M20x1.5

## Torx safety screws

Packs of **10 pcs.**

Pan head screws with Torx fitting and pin, stainless steel.  
Use a thread locker where required for applications acc. to. EN ISO 14119.

Article	Description
VF VAM4X10BX-X	M4x10 screw, with Torx T20 fitting, AISI 304
VF VAM4X15BX-X	M4x15 screw, with Torx T20 fitting, AISI 304
VF VAM4X20BX-X	M4x20 screw, with Torx T20 fitting, AISI 304
VF VAM4X25BX-X	M4x25 screw, with Torx T20 fitting, AISI 304
VF VAM4X30BX-X	M4x30 screw, with Torx T20 fitting, AISI 304
VF VAM5X10BX-X	M5x10 screw, with Torx T25 fitting, AISI 304
VF VAM5X15BX-X	M5x15 screw, with Torx T25 fitting, AISI 304
VF VAM5X20BX-X	M5x20 screw, with Torx T25 fitting, AISI 304
VF VAM5X25BX-X	M5x25 screw, with Torx T25 fitting, AISI 304
VF VAM5X35BX-X	M5x35 screw, with Torx T25 fitting, AISI 304
VF VAM5X45BX-X	M5x45 screw, with Torx T25 fitting, AISI 304

## OneWay safety screws

Packs of **10 pcs.**

Pan head screws with OneWay fitting and pin, stainless steel.  
This screw type cannot be removed or tampered with using common tools. Ideal for fixing safety device actuators in accordance with EN ISO 14119.

Article	Description
VF VAM4X10BW-X	M4x10 screw, with OneWay fitting, AISI 304
VF VAM4X15BW-X	M4x15 screw, with OneWay fitting, AISI 304
VF VAM4X20BW-X	M4x20 screw, with OneWay fitting, AISI 304
VF VAM4X25BW-X	M4x25 screw, with OneWay fitting, AISI 304
VF VAM5X10BW-X	M5x10 screw, with OneWay fitting, AISI 304
VF VAM5X15BW-X	M5x15 screw, with OneWay fitting, AISI 304
VF VAM5X20BW-X	M5x20 screw, with OneWay fitting, AISI 304
VF VAM5X25BW-X	M5x25 screw, with OneWay fitting, AISI 304

## Bits for Torx safety screws

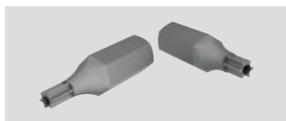

Bits for Torx safety screws with pin, with ¼" hexagonal connection.

Article	Description
VF VAIT1T20	Bits for M4 screws with Torx T20 fitting
VF VAIT1T25	Bits for M5 screws with Torx T25 fitting
VF VAIT1T30	Bits for M6 screws with Torx T30 fitting

All values in the drawings are in mm

→ The 2D and 3D files are available at [www.pizzato.com](http://www.pizzato.com)

### Fixing plates



Metal fixing plate, for fixing rope switches on the ceiling.

The plate is provided with bore holes for fastening switches of the FD, FL, FC, FP, FR, FM, FZ, FX, FK series. It is supplied without screws.

Article	Description
VF SFP2	Ceiling fixing plate

### Fixing plates



Fixing plate (complete with fastening screws) provided with long slots for adjusting the operating point.

Each plate is provided with two pairs of fixing holes, one for standard switches and one for switches with reset device. The actuator thus always has the same actuating point.

Article	Description
VF SFP1	Fixing plate (FR series)
VF SFP3	Fixing plate (FX series)

## LED signalling lights

Packs of 5 pcs.



These signalling lights with high luminosity LEDs are used for signalling that an electric contact has changed its state inside the switch. They can be installed on switches of the FL, FX, FZ, FW, FG, NG or FS series by screwing them on one of the conduit entries not used for electric cables. They can be used for many different purposes: for example, to signal, from a distance, whether the switch has been actuated; whether the guard has closed correctly; or whether the guard is locked or unlocked.

The inner part can rotate in such a way that it can be wired and screwed on the switch without any risk of twisting the wires.

**Features:**

Protection degree:

IP67 acc. to EN 60529

Ambient temperature:

IP69K acc. to ISO 20653

Operating voltage  $U_n$ :

-25°C ... +70°C

24 Vac/dc (10 mA)

120 Vac (20 mA)

230 Vac (20 mA)

Tolerance on the supply voltages:

 $\pm 15\%$  of  $U_n$ 

Operating current:

10 mA

Connection system:

PUSH-IN spring type

Cross-section of rigid/flexible wires w. wire-end sleeve:

min. 1 x 0.34 mm<sup>2</sup> (1 x AWG 24)max. 1 x 1.5 mm<sup>2</sup> (1 x AWG 16)

Wire cross-section with pre-insulated wire-end sleeve:

min. 1 x 0.34 mm<sup>2</sup> (1 x AWG 24)max. 1 x 0.75 mm<sup>2</sup> (1 x AWG 18)

Tightening torque:

1.2 ... 2 Nm

Wire stripping length (x):

min.: 8 mm

max.: 12 mm

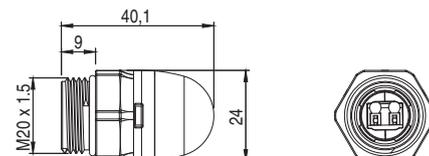
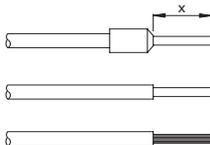

## Application examples

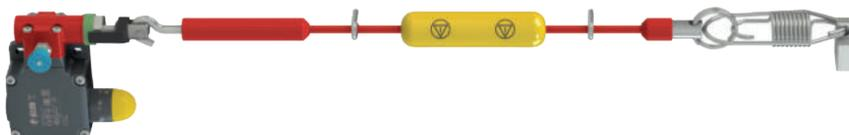

Status indicator for safety rope switches



Indication of unlocked door

## Code structure

**Attention!** The feasibility of a code number does not mean the effective availability of a product. Please contact our sales office

## VF SL1A3PA1

## Operating voltage

<b>1</b>	24 Vac/dc
<b>3</b>	120 Vac
<b>4</b>	230 Vac

## Type of light source

<b>A</b>	standard LED with continuous light
----------	------------------------------------

## Body design

<b>A</b>	Total height 40 mm, spherical lens, threading M20x1.5mm
----------	---

## Connection type

<b>P</b>	PUSH-IN terminal strip
----------	------------------------

## Lens colour

<b>2</b>	White
<b>3</b>	Red
<b>4</b>	Green
<b>5</b>	Yellow

## Stock items

VF SL1A3PA1
VF SL1A5PA1

All values in the drawings are in mm

→ The 2D and 3D files are available at [www.pizzato.com](http://www.pizzato.com)

**Junction box for series connection of up to 4 devices**



This accessory allows easy and precise series connection of up to 4 devices. Thanks to the numbered terminals and to the internal circuit, it is sufficient to connect the conductors in the slots provided with the practical and fast PUSH-IN spring connections. Thanks to the four internal microswitches, it is possible to easily and immediately direct the device signalling outputs (open or closed, locked or unlocked) to one of the four available auxiliary channels and then manage the information independently for each channel through a PLC.

**Features:**  
Material:

Self-extinguishing shock-proof polycarbonate with double insulation, UV-resistant and glass fibre reinforced  
Stainless steel

Material of the screws:  
Protection degree:

IP67 acc. to EN 60529, IP69K acc. to ISO 20653, with cable gland of equal or higher protection degree

Conduit entries:

2x M20 - 1/2 NPT knock-out side entries  
2x M20 - 1/2 NPT - M25 knock-out side entries  
2x M16 knock-out base entries

Ambient temperature:

-40°C ... +80°C

Tightening torque of the cover screws: 1 ... 1.4 Nm

Connection system: PUSH-IN spring type

Cross-section of rigid/flexible wires w. wire-end sleeve:

min. 1 x 0.34 mm<sup>2</sup> (1 x AWG 24)  
max. 1 x 1.5 mm<sup>2</sup> (1 x AWG 16)

Wire cross-section with pre-insulated wire-end sleeve:

min. 1 x 0.34 mm<sup>2</sup> (1 x AWG 24)  
max. 1 x 0.75 mm<sup>2</sup> (1 x AWG 18)

Wire stripping length (x):

min.: 8 mm  
max.: 12 mm



**Pin assignment**

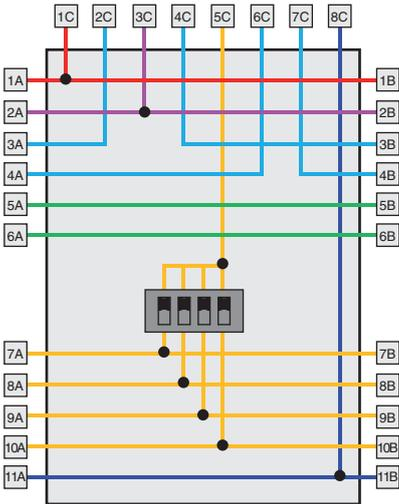

Article	Description
VF CY302P0	Junction box for series connection of up to 4 devices

Terminal box	Connection	Terminal box	Connection
1A / 1B	A1 Supply input +24 Vdc	1C	A1 Supply input +24 Vdc
2A / 2B	A2 Supply input 0 V	2C	OS1 Safety output
3A / 3B	OS1 / IS1 Safety output / safety input	3C	A2 Supply input 0 V
4A / 4B	OS2 / IS2 Safety output / safety input	4C	IS1 Safety input
5A / 5B	Auxiliary connection	5C	O3 Signalling output, actuator inserted
6A / 6B	Auxiliary connection	6C	O4 Signalling output, actuator inserted and locked
7A / 7B	OAU1 Auxiliary output Oaux1	7C	OS2 Safety output
8A / 8B	OAU2 Auxiliary output Oaux2	8C	IS2 Safety input
9A / 9B	OAU3 Auxiliary output Oaux3		
10A / 10B	OAU4 Auxiliary output Oaux4		
11A / 11B	I4 Solenoid activation input		

**Example of series connection of 4 NG series switches**

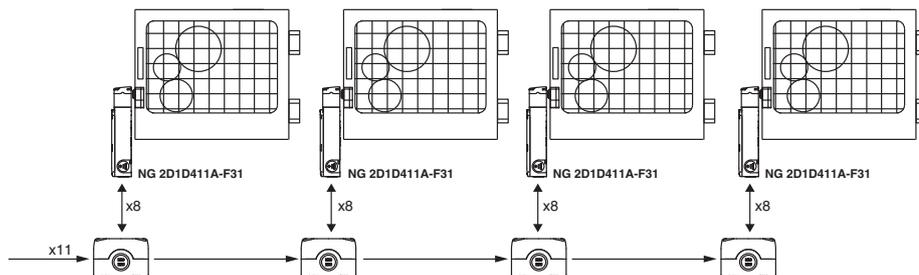

**Wiring diagram**

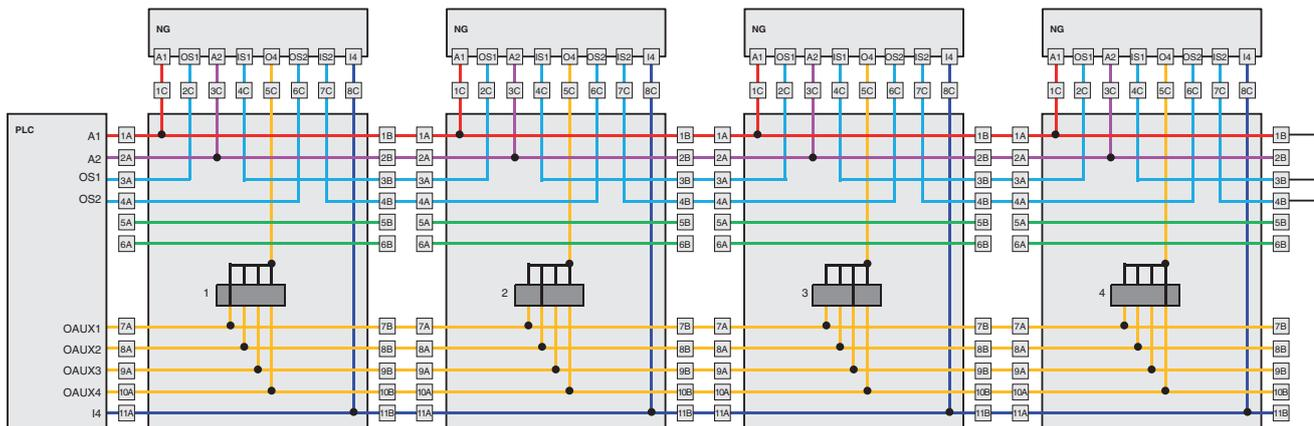





### Installation of single switches with safety functions

- Use **only** switches with the symbol  (see figure on the side).
- Connect the safety circuit to **the NC normally closed contacts (11-12, 21-22 or 31-32)**.
- **The NO normally open contacts (13-14, 23-24, 33-34)** should be used **only for signalling**; these contacts are not to be connected with the safety circuit. However, if two or more switches are used on the same guard, a connection can be established between the NO contacts and the safety circuit. In this case at least one of the two switches must have positive opening and a normally closed contact NC (11-12, 21-22 or 31-32) must be connected to the safety circuit.
- Actuate the switch **at least up to the positive opening travel** shown in the travel diagrams with symbol .
- The actuation system must be able to exert a force that is greater than the **positive opening force**, as specified in brackets below each article, next to the minimum force value.
- The device must be affixed in compliance with EN ISO 14119.



Whenever the machine guard is opened and during the whole opening travel, **the switch must be pressed directly** (fig. 1) **or through a rigid connection** (fig. 2).

Only in this way the positive opening of the normally closed NC contacts (11-12, 21-22, 31-32) is guaranteed.

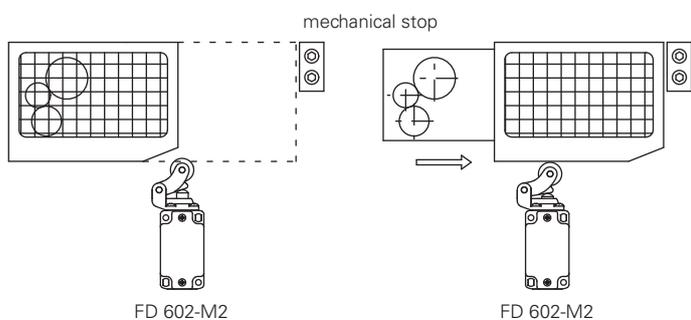
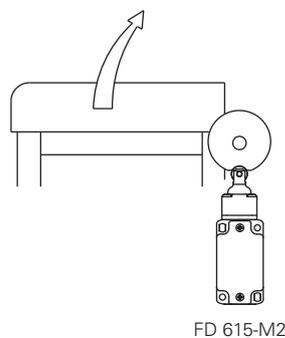
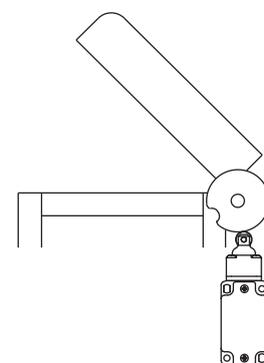

Fig.1



FD 615-M2



FD 615-M2

Fig.2

In safety applications with only one switch for each guard, the switches **must never be activated by a release** (fig. 3 and 4) **or through a non rigid connection** (i.e. by a spring).

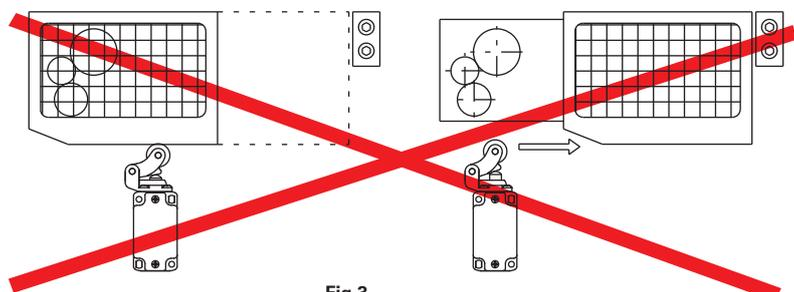

Fig.3

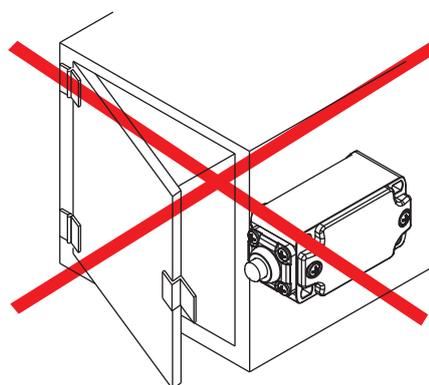
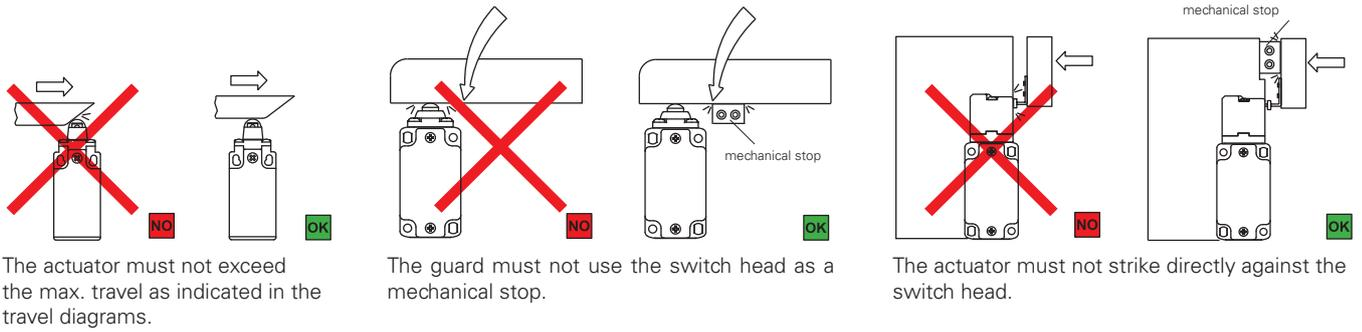

Fig.4

**Mechanical stop**

Acc. to EN ISO 14119 paragraph 5.2 letter h) the position sensors must not be used as mechanical stop.



The actuator must not exceed the max. travel as indicated in the travel diagrams.

The guard must not use the switch head as a mechanical stop.

The actuator must not strike directly against the switch head.

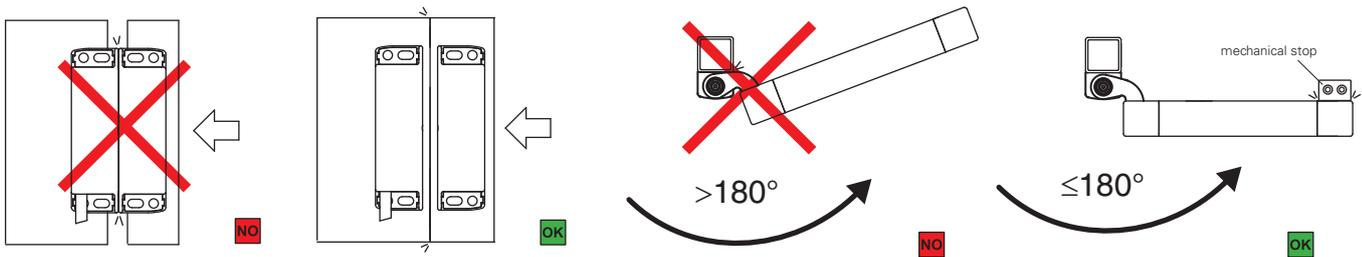

The actuator must not strike directly against the magnetic sensor.

The opening angle of safety hinge switch HP, HC and HX series must not exceed 180°.

**Actuation modes**

Recommended application	Application to avoid <small>This application is possible, but increased mechanical stress may shorten the operating life of the switch</small>	Forbidden application

Switches for heavy duty applications

Maximum and minimum actuation speed - FD-FL-FP-FC series

Roller lever - Type 1

$\phi$	Vmax (m/s)	Vmin (mm/s) L	Vmin (mm/s) R
15°	2,5	9	0,07
30°	1,5	8	
45°	1	7	
60°	0,75	7	

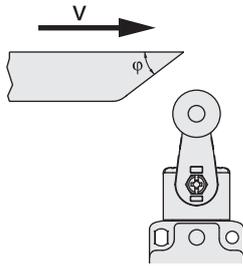

Roller plunger - Type 2

$\phi$	Vmax (m/s)	Vmin (mm/s) L	Vmin (mm/s) R
15°	1	4	0,04
30°	0,5	2	0,02
45°	0,3	1	0,01

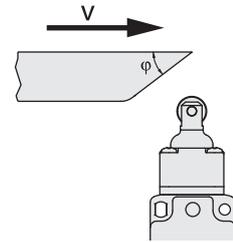

Roller lever - Type 3

$\phi$	Vmax (m/s)	Vmin (mm/s) L	Vmin (mm/s) R
15°	1	5	0,05
30°	0,5	2,5	0,025
45°	0,3	1,5	0,015

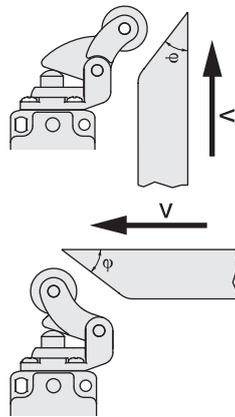

Plunger - Type 4

Vmax (m/s)	Vmin (mm/s) L	Vmin (mm/s) R
0,5	1	0,01

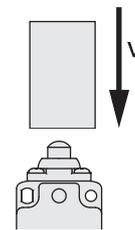

Contact type:

- R** = snap action
- L** = slow action

Tightening torques FD-FP-FL-FC-FG-FS-NG-NS series

- 1** Cover screws **0.8 ... 1.2 Nm**
- 2** Head screws **0.8 ... 1.2 Nm**
- 3** Lever screw **0.8 ... 1.2 Nm**
- 4** Protection caps (conduit entry M20/PG13.5) **1.2 ... 1.6 Nm**  
(conduit entry M16/PG11) **1 ... 1.4 Nm**
- 5** Contact block screws **0.6 ... 0.8 Nm**
- 6** M5 fixing screws, body FD, FP, FL, FC, FG, FS, NG (with washer for FS series) **2 ... 3 Nm**
- 7** M5 fixing screws, body NS (with washer) **3 Nm**
- 8** Actuator screws VF KEY... **1.2 ... 1.6 Nm**

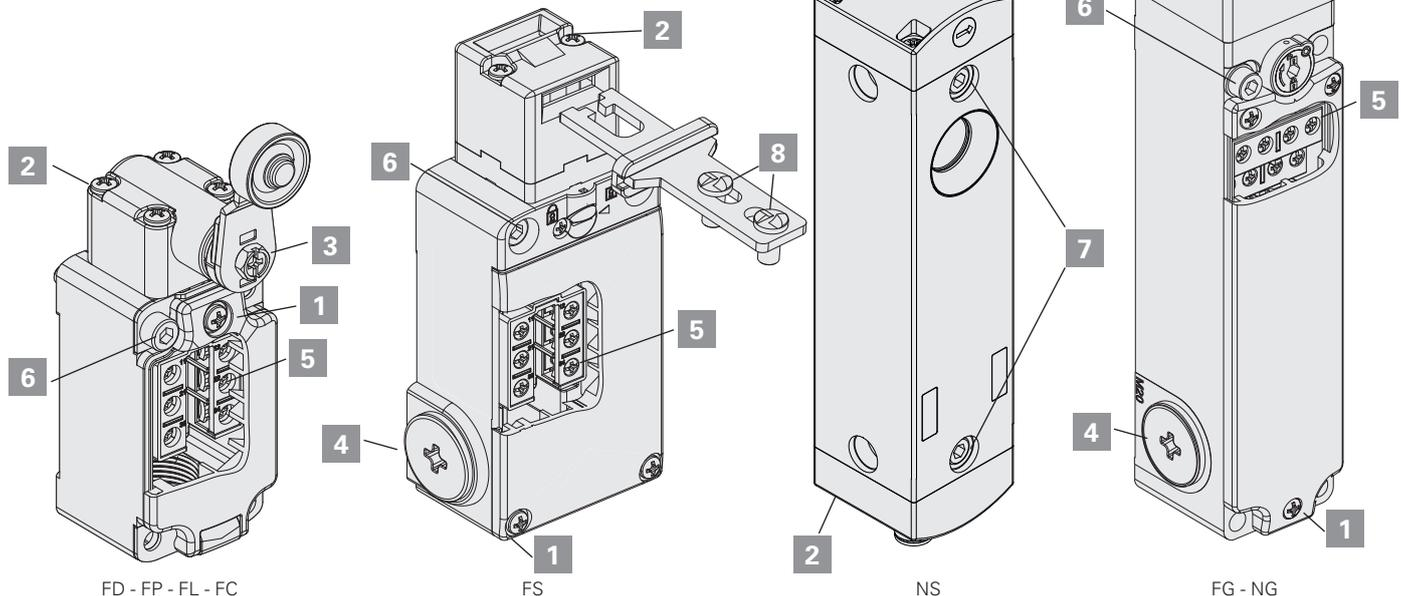

# FD-FP-FL-FC series switches for heavy duty applications

## Travel diagrams

Contact block	Group 1	Group 2	Group 3	Group 4	Group 5	Group 6 inverted contacts
2 2x(1NO-1NC) 						
3 1NO-1NC 						
5 1NO+1NC 						
6 1NO+1NC 			/			
7 1NO+1NC 			/			
9 2NC 			/			
10 2NO 						
11 2NC 			/		/	
12 2NO 			/			
13 2NC 			/			
14 2NC 			/			
15 2NO 			/			
16 2NC 	/	/	/		/	/
18 1NO+1NC 						
20 1NO+2NC 						
21 3NC 						
22 2NO+1NC 						
28 1NO+2NC 			/			/
29 3NC 			/			/
30 3NC 			/			/
33 1NO+1NC 						
34 2NC 						
37 1NO+1NC 			/			
66 1NC 			/			
67 1NO 						

**Legend**

Closed contact | 
 Open contact | 
 Positive opening travel acc. to EN 60947-5-1 | 
 Switch pressed / 
 Switch released

Switches for standard applications

Maximum and minimum actuation speed - FR-FM-FX-FZ-FK series

Roller lever - Type 1

φ	Vmax (m/s)	Vmin (mm/s)	
		L	R
15°	2,5	9	0,07
30°	1,5	8	
45°	1	7	
60°	0,75	7	

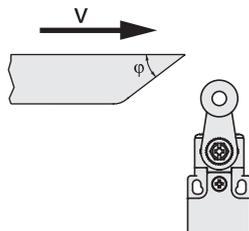

Roller plunger - Type 2

φ	Vmax (m/s)	Vmin (mm/s)	
		L	R
15°	1	4	0,04
30°	0,5	2	0,02
45°	0,3	1	0,01

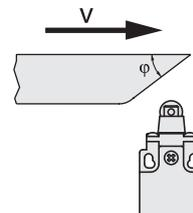

Roller lever - Type 3

φ	Vmax (m/s)	Vmin (mm/s)	
		L	R
15°	1	5	0,05
30°	0,5	2,5	0,025
45°	0,3	1,5	0,015

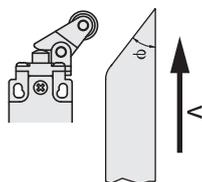

Plunger - Type 4

Vmax (m/s)	Vmin (mm/s)	Vmin (mm/s)
	L	R
0,5	1	0,01

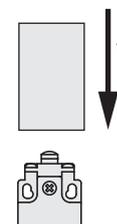

Contact type:

- R** = snap action
- L** = slow action

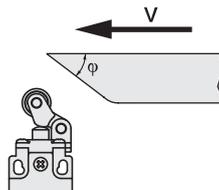

Roller plunger - Type 5

φ	Vmax (m/s)	Vmin (mm/s)	
		L	R
15°	0,3	4	0,04
30°	0,2	2	0,02

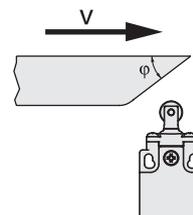

Tightening torques - FR, FX, FK and FW series

- |   |                       |
|---|-----------------------|
| <b>1</b> Cover screws   | <b>0.7 ... 0.9 Nm</b> |
| <b>2</b> Head screws  | <b>0.5 ... 0.7 Nm</b> |
| <b>3</b> Lever screw  | <b>0.7 ... 0.9 Nm</b> |
| <b>4</b> Protection caps  | <b>1.2 ... 1.6 Nm</b> |
| <b>5</b> Contact block screws                                     | <b>0.6 ... 0.8 Nm</b> |
| <b>6</b> M4 fixing screws, body<br>(with washer for FR-FK series) | <b>2 ... 2.5 Nm</b>   |
| <b>7</b> M5 fixing screws, body<br>(with washer for FW series)    | <b>2 ... 2.5 Nm</b>   |
| <b>8</b> Actuator screws VF KEY•••                                | <b>1.2 ... 1.6 Nm</b> |

Tightening torques - FM and FZ series

- |                                 |                       |
|---------------------------------|-----------------------|
| <b>1</b> Cover screws           | <b>0.5 ... 0.7 Nm</b> |
| <b>2</b> Head screws            | <b>0.5 ... 0.7 Nm</b> |
| <b>3</b> Lever screw            | <b>0.8 ... 1.2 Nm</b> |
| <b>4</b> Protection caps        | <b>1.2 ... 1.6 Nm</b> |
| <b>5</b> Contact block screws   | <b>0.6 ... 0.8 Nm</b> |
| <b>6</b> M4 fixing screws, body | <b>2 ... 3 Nm</b>     |

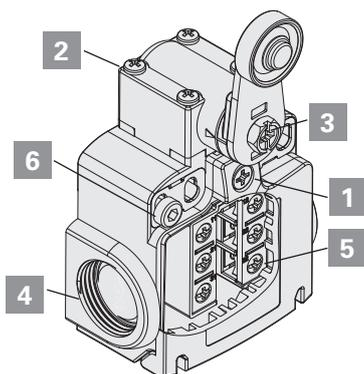

FR - FX - FK - FM

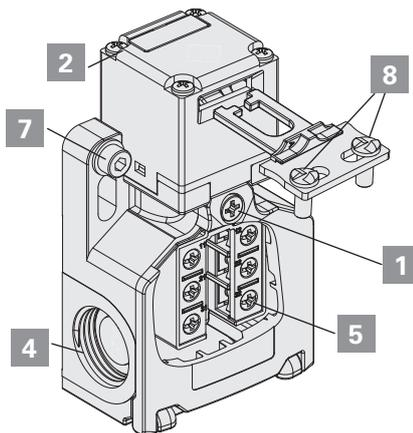

FW

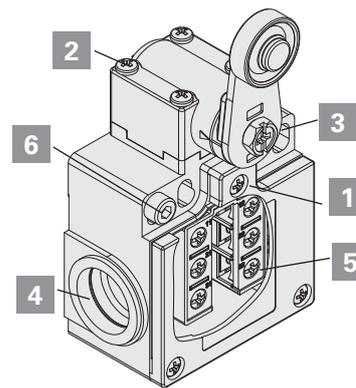

FZ

# FR-FM-FX-FZ-FK series switches for standard applications

## Travel diagrams

Contact block	Group 1	Group 2	Group 3	Group 4	Group 5	Group 6	Group 7 inverted contacts
2 2x(1NO-1NC) 							
3 1NO-1NC 							
5 1NO+1NC 							
6 1NO+1NC 				/			
7 1NO+1NC 				/			
9 2NC 				/			
10 2NO 							
11 2NC 				/		/	
12 2NO 							
13 2NC 				/			
14 2NC 				/			
15 2NO 				/			
16 2NC 	/	/	/	/		/	/
18 1NO+1NC 							
20 1NO+2NC 							
21 3NC 							
22 2NO+1NC 							
28 1NO+2NC 				/			
29 3NC 				/			
30 3NC 				/			
33 1NO+1NC 							
34 2NC 							
37 1NO+1NC 				/			
66 1NC 							
67 1NO 							

(\*) Positive opening of NC contacts (11-12 / 21-22 / 31-32) with 22 actuator with rigid rod only. Do not operate the 22 actuator with rigid rod at an angle of more than 27°.

### Legend

■ Closed contact | □ Open contact | ⊕ Positive opening travel acc. to EN 60947-5-1 | ▶ Switch pressed / ◀ Switch released

FR-FM-FX-FZ-FK series switches with W3 reset for standard applications

Travel diagrams

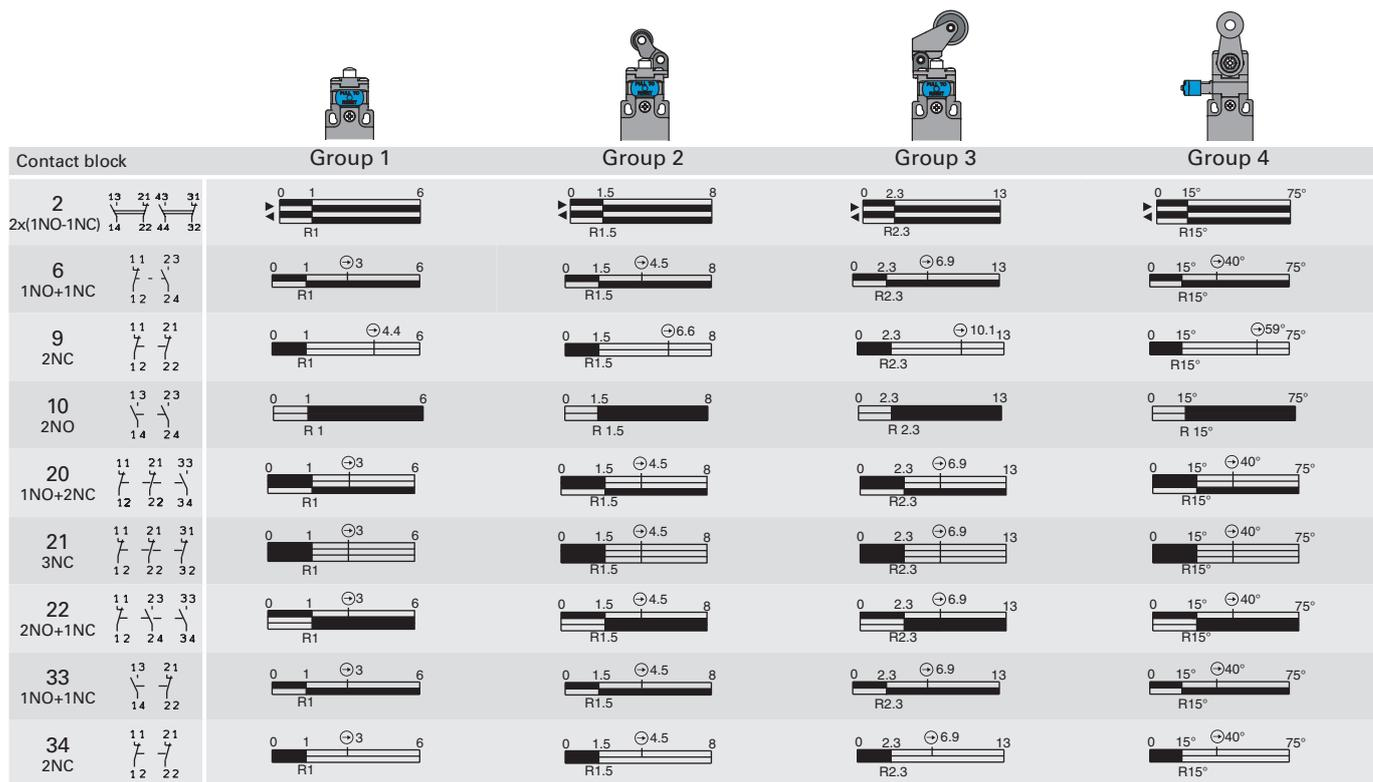

**Legend**  
 Closed contact | Open contact | Positive opening travel acc. to EN 60947-5-1 | Switch pressed / Switch released | R reset engagement travel



# FR-FM-FX-FZ-FK-FW series switches for safety applications

## Travel diagrams

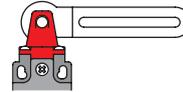

Contact block		Group 8	Group 9	Group 10	Group 11
5 1NO+1NC					
6 1NO+1NC					
7 1NO+1NC				/	/
9 2NC					
11 2NC			/	/	/
13 2NC			/	/	/
14 2NC				/	/
18 1NO+1NC					
20 1NO+2NC					
21 3NC					
22 2NO+1NC					
33 1NO+1NC					
34 2NC					
37 1NO+1NC			/	/	/
66 1NC					

**Legend**

Closed contact | 
 Open contact | 
 Positive opening travel acc. to EN 60947-5-1 | 
 Switch pressed / 
 Switch released

## FA-NA-NB-NF series modular pre-wired switches

## Maximum and minimum actuation speed

## Roller lever - Type 1

$\varphi$	Vmax (m/s)	Vmin (mm/s) L	Vmin (mm/s) R
15°	2,5	9	0,07
30°	1,5	8	
45°	1	7	
60°	0,75	7	

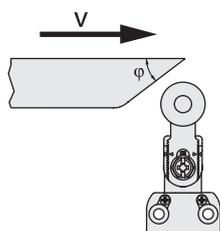

## Roller plunger - Type 2

$\varphi$	Vmax (m/s)	Vmin (mm/s) L	Vmin (mm/s) R
15°	1	4	0,04
30°	0,5	2	0,02
45°	0,3	1	0,01

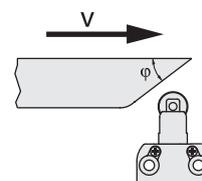

## Roller lever - Type 3

$\varphi$	Vmax (m/s)	Vmin (mm/s) L	Vmin (mm/s) R
15°	1	5	0,05
30°	0,5	2,5	0,025
45°	0,3	1,5	0,015

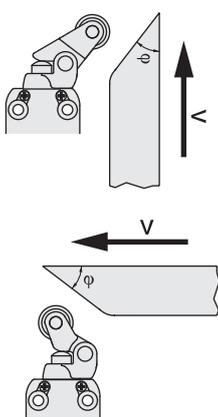

## Plunger - Type 4

Vmax (m/s)	Vmin (mm/s) L	Vmin (mm/s) R
0,5	1	0,01

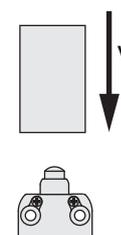

## Roller plunger - Type 5

$\varphi$	Vmax (m/s)	Vmin (mm/s) L	Vmin (mm/s) R
15°	0,3	4	0,04

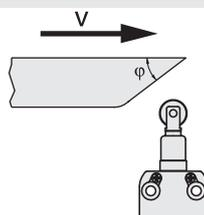

Contact type:

**R** = snap action  
**L** = slow action

## Screw tightening torques

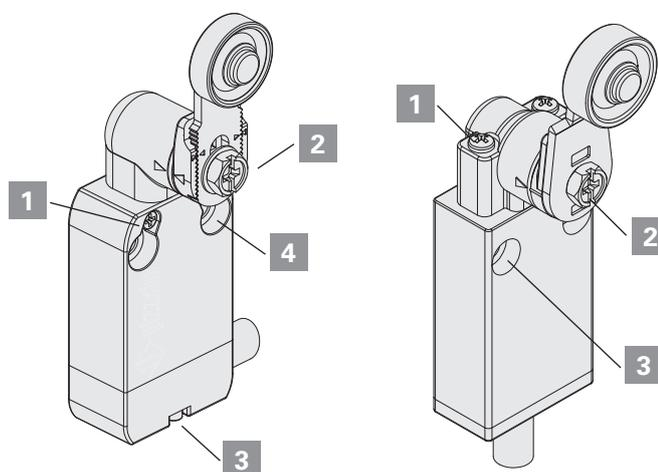

NA - NB - NF

FA

## For NA and NB series:

<b>1</b> Head screws	<b>0.5 ... 0.7 Nm</b>
<b>2</b> Lever screw	<b>0.8 ... 1.2 Nm</b>
<b>3</b> Connector screw	<b>0.3 ... 0.6 Nm</b>
<b>4</b> M4 fixing screws, body	<b>2 ... 3 Nm</b>

## For NF series:

<b>1</b> Head screws	<b>0.3 ... 0.4 Nm</b>
<b>2</b> Lever screw	<b>0.8 ... 1.2 Nm</b>
<b>3</b> Connector screw	<b>0.2 ... 0.3 Nm</b>
<b>4</b> M4 fixing screws, body	<b>2 ... 3 Nm</b>

## For FA series:

<b>1</b> Head screws	<b>0.5 ... 0.7 Nm</b>
<b>2</b> Lever screw	<b>0.8 ... 1.2 Nm</b>
<b>3</b> M4 fixing screws, body	<b>2 ... 3 Nm</b>

## NA-NB-NF series modular pre-wired switches

### Travel diagrams

Contact block	Group 1	Group 2	Group 3	Group 4	Group 5	Group 6
<b>B11</b> 1NO+1NC						
<b>B02</b> 2NC						
<b>B12</b> 1NO+2NC						
<b>B22</b> 2NO+2NC						
<b>G11</b> 1NO+1NC				/		
<b>G02</b> 2NC						
<b>G12</b> 1NO+2NC				/		
<b>G22</b> 2NO+2NC				/		
<b>H11</b> 1NO+1NC						
<b>H12</b> 1NO+2NC						
<b>H22</b> 2NO+2NC						
<b>L11</b> 1NO+1NC						
<b>L12</b> 1NO+2NC						
<b>L22</b> 2NO+2NC						
<b>BA1</b> 1NO+1NC change-over						

## FA series pre-wired switches

### Travel diagrams

Contact block	Group 1	Group 2	Group 3	Group 4
<b>41</b> 1NO+1NC				
<b>45</b> 1NO+1NC				
<b>46</b> 1NO+1NC				
<b>48</b> 1NO+1NC				

**Legend**

Closed contact | 
 Open contact | 
 Positive opening travel acc. to EN 60947-5-1 | 
 Switch pressed / 
 Switch released

**MK series microswitches**

**Maximum and minimum actuation speed**

**Plunger - Type 1**

Vmax (m/s)	Vmin (mm/s)
0,5	0,05

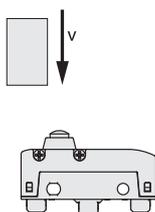

**Roller plunger - Type 2**

$\phi$	Vmax (m/s)	Vmin (mm/s)
15°	0,6	0,2
30°	0,3	0,1
45°	0,1	0,05

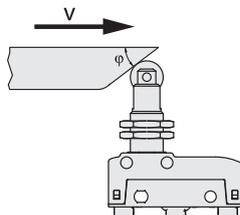

**Lever with direct action (D) - Type 3**

Vmax (m/s)	Vmin (mm/s)
$0,03 \times L$	$0,0166 \times L$

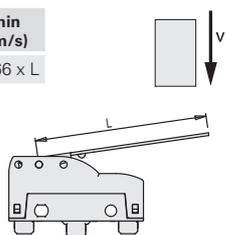

**Lever with inverted action (R) - Type 4**

Vmax (m/s)	Vmin (mm/s)
$0,015 \times L$	$0,0083 \times L$

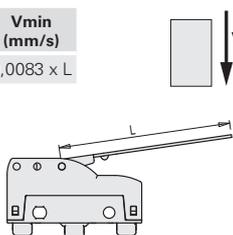

**Lever with direct action, rear (F) - Type 5**

Vmax (m/s)	Vmin (mm/s)
$0,01 \times L$	$0,0047 \times L$

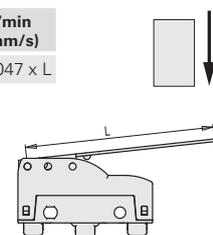

**Roller lever with direct action (D) - Type 6**

$\phi$	Vmax (m/s)	Vmin (mm/s)
15°	$0,1 \times L$	$0,0664 \times L$
30°	$0,05 \times L$	$0,0332 \times L$
45°	$0,03 \times L$	$0,0166 \times L$

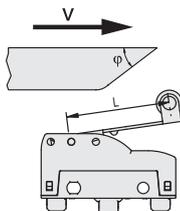

**Roller lever with inverted action (R) - Type 7**

$\phi$	Vmax (m/s)	Vmin (mm/s)
15°	$0,048 \times L$	$0,0332 \times L$
30°	$0,024 \times L$	$0,0166 \times L$
45°	$0,015 \times L$	$0,0083 \times L$

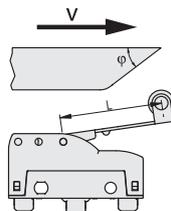

**Roller lever with direct action, rear (F) - Type 8**

$\phi$	Vmax (m/s)	Vmin (mm/s)
15°	$0,032 \times L$	$0,0188 \times L$
30°	$0,016 \times L$	$0,0094 \times L$
45°	$0,01 \times L$	$0,0047 \times L$

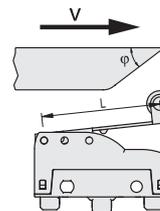

**Tightening torques**

- |   |  |                       |
|---|--|-----------------------|
| 1 | Head nuts                              | <b>2 ... 3 Nm</b>     |
| 2 | Head screws                            | <b>0.3 ... 0.4 Nm</b> |
| 3 | Terminal screws                        | <b>0.6 ... 0.8 Nm</b> |
| 4 | M4 fixing screws, body (insert washer) | <b>0.8 ... 1.2 Nm</b> |

Attention: A tightening torque higher than 1.2 Nm can cause the breaking of the microswitch.

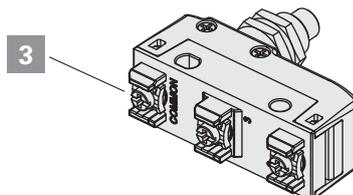
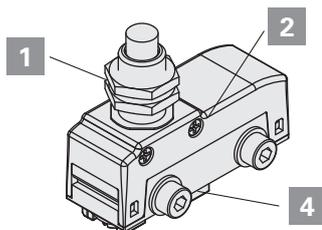

## MS-MF series microswitches

### Maximum and minimum actuation speed

#### Plunger - Type 1

Vmax (m/s)	Vmin (mm/s)
0,5	0,05

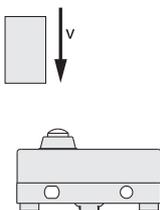

#### Roller plunger - Type 2

$\varphi$	Vmax (m/s)	Vmin (mm/s)
15°	0,6	0,2
30°	0,3	0,1
45°	0,1	0,05

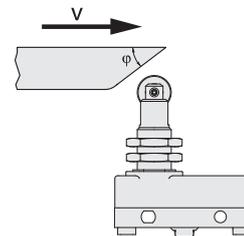

#### Lever with direct action (D) - Type 3

Vmax (m/s)	Vmin (mm/s)
0,03 x L	0,0166 x L

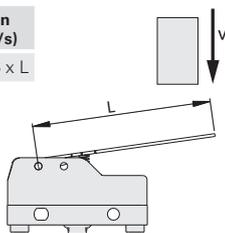

#### Roller lever with direct action (D) - Type 6

$\varphi$	Vmax (m/s)	Vmin (mm/s)
15°	0,1 x L	0,0664 x L
30°	0,05 x L	0,0332 x L
45°	0,03 x L	0,0166 x L

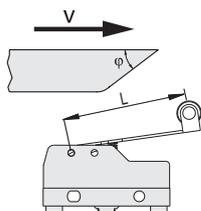

#### Roller lever with inverted action (R) - Type 7

$\varphi$	Vmax (m/s)	Vmin (mm/s)
15°	0,048 x L	0,0332 x L
30°	0,024 x L	0,0166 x L
45°	0,015 x L	0,0083 x L

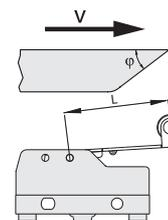

### Tightening torques

- |   |                       |
|---|-----------------------|
| <b>1</b> Head nuts                              | <b>2 ... 3 Nm</b>     |
| <b>2</b> Head screw                             | <b>0.3 ... 0.4 Nm</b> |
| <b>3</b> Terminal screws                        | <b>0.6 ... 0.8 Nm</b> |
| <b>4</b> M4 fixing screws, body (insert washer) | <b>0.8 ... 1.2 Nm</b> |

Attention: A tightening torque higher than 1.2 Nm can cause the breaking of the microswitch.

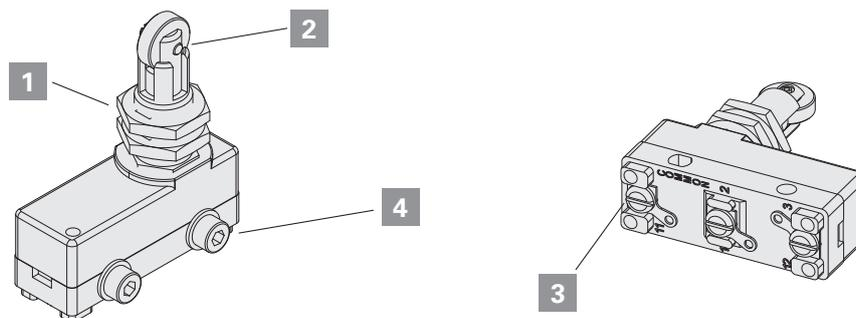

### General requirements

The device is designed to be installed on industrial machineries. The installation must be performed only by qualified staff aware of the regulations in force in the country of installation. The device must be used exactly as supplied, properly fixed to the machine and wired.

It is not allowed to disassemble the product and use only parts of the same, the device is designed to be used in its assembly as supplied. It is prohibited to modify the device, even slightly e.g.: replace parts of it, drill it, lubricate it, clean it with gasoline or gas oil or any aggressive chemical agents.

The protection degree of the device refers to the electrical contacts only. Carefully evaluate all the polluting agents present in the application before installing the device, since the IP protection degree refers exclusively to agents such as dust and water according to EN 60529. Thus the device may not be suitable for installation in environments with dust in high quantity, condensation, humidity, steam, corrosive and chemical agents, flammable or explosive gas, flammable or explosive dust or other polluting agents.

Some devices are provided with a housing with openings for connecting the electrical cables. To guarantee an adequate protection degree of the device, the opening that the wiring passes through must be protected against the penetration of harmful materials by means of an appropriate seal. Proper wiring therefore requires the use of cable glands, connectors or other devices with IP protection degree that is equal to or greater than that of the device.

Store the products in their original packaging, in a dry place with temperature between -40° C and +70°C

Failure to comply with these requirements or incorrect use during operation can lead to the damage of the device and the loss of the function performed by the device itself. This will result in termination of the warranty on the item and will release the manufacturer from any liability.

### Using the devices

- Before use, check if the national rules provide for further requirements in addition to those given here.
- Before installation, make sure the device is not damaged in any part.
- All devices are designed for actuation by moving parts of industrial machines.
- Do not use the device as mechanical stop of the actuator.
- Do not apply excessive force to the device once it has reached the end of its actuation travel.
- Do not exceed the maximum actuation travel.
- Avoid contact of the device with corrosive fluids.
- Do not stress the device with bending and torsion.
- Do not disassemble or try to repair the device, in case of defect or fault replace the entire device.
- In case the device is deformed or damaged it must be entirely replaced. Correct operation cannot be guaranteed when the device is deformed or damaged.
- Always attach the following instructions to the manual of the machine in which the device is installed.
- If specific operating instructions exist for a device (supplied or downloadable from [www.pizzato.com](http://www.pizzato.com)), they must always be included with the machine manual and be available for the entire service life of the machine.
- These operating instructions must be kept available for consultation at any time and for the whole period of use of the device.

### Wiring and installation

- Installation must be carried out by qualified staff only.
  - Use of the device is limited to function as a control switch.
  - Observe minimum distances between devices (if provided).
  - Comply with the tightening torques indicated in this catalogue.
  - Keep the electrical load below the value specified by the respective utilization category.
  - Disconnect the power before to work on the contacts, also during the wiring.
  - Do not paint or varnish the devices.
  - Install the product on flat and clean surfaces only.
  - Do not bend or deform the device during installation.
  - Never use the device as support for other machine components (cable ducts, tubes, etc.)
  - For installation on the machine, use the intended bore holes in the housing. The device must be fixed with screws of adequate length and resistance to the expected stress. At least two screws (fitted to holes most suitable for the intended use) are required to fix the housing to the machine.
  - After and during installation, do not pull the electrical cables connected to the device. If excessive tension is applied to the cables (that is not supported by an appropriate cable gland), the contact block of the device may be damaged.
  - Provided that the device has an electrical connector, always switch off the circuit voltage before disconnecting the connector from the switch. The connector is not suitable for separation of electrical loads.
  - During wiring comply with the following requirements:
    - for terminals (if present), comply with the minimum and maximum cross-sections of the conductors;
    - tighten the electrical terminals (if present) with the torque indicated in this catalogue;
    - do not introduce polluting agents into the device as: talc, lubricants for cable sliding, powder separating agents for multipolar cables, small strands of copper and other pollutants that could affect the proper functioning of the device;
    - before closing the device cover (if present) verify the correct positioning of the gaskets;
    - verify that the electrical cables, wire-end sleeves, cable numbering systems and any other parts do not obstruct the cover from closing correctly or if pressed between them do not damage or compress the internal contact block;
    - for devices with integrated cable, the free end of the cable must be properly connected inside a protected housing. The electrical cable must be properly protected from cuts, impacts, abrasion, etc. After installation and before commissioning of the machine, verify:
      - the correct operation of the device and all its parts;
      - the correct wiring and tightening of all screws;
      - the actuating travel of the actuator must be shorter than the maximum travel allowed by the device.
  - After installation, periodically check for correct device operation.
- Do not use in following environments:**
- Environments where dust and dirt can cover the device and by sedimentation stop its correct working.
  - Environment where sudden temperature changes cause condensation.
  - Environments where coatings of ice may form on the device.
  - Environments where the application causes knocks or vibra-

tions that could damage the device.

- Environment with presence of explosive or flammable gas or dust. The current limit does not apply to devices declared compliant with directive ATEX 2014/34/EU.

### Limits of use

- Use the devices following the instructions, complying with their operation limits and the standards in force.
- The devices have specific application limits (min. and max. ambient temperature, mechanical endurance, protection degree, utilisation category, etc.) These limits are met by the different devices only if considered individually and not if combined with each other. For further information contact our technical department.
- The utilization implies knowledge of and compliance with following standards: EN 60204-1, EN 60947-5-1, ISO 12100, EN ISO 14119.
- Please contact our technical department for information and assistance (phone +39.0424.470.930 / fax +39.0424.470.955 / e-mail tech@pizzato.com) in the following cases:
- Cases not mentioned in the present utilization requirements.
- In nuclear power stations, trains, airplanes, cars, incinerators, medical devices or any application where the safety of two or more persons depend on the correct operation of the device.

### Additional requirements for safety applications

- Provided that all previous requirements for the devices are fulfilled, for installations with operator protection function additional requirements must be observed.
- The utilization implies knowledge of and compliance with following standards: IEC 60204-1, IEC 60947-5-1, ISO 12100, EN ISO 14119, EN 62061, EN ISO 13849-1, EN ISO 13850.
- The protection fuse (or equivalent device) must be always connected in series with the NC contacts of the safety circuit.
- Periodically verify the correct working of the safety devices; the periodicity of this verification is settled by the machine manufacturer based on the machine danger degree and it does not have to be less than one a year.
- After installation and before commissioning of the machine, verify:
  - the correct operation of the device and all its parts;
  - the correct wiring and tightening of all screws;
  - the actuating travel of the actuator must be shorter than the maximum travel allowed by the device;
  - the actuating travel of the actuator must be greater than the positive opening travel;
  - the actuation system must be able to exert a force that is greater than the positive opening force.
- Devices with a safety function have a limited service life. Although still functioning, after 20 years from the date of manufacture the device must be replaced completely.
- The production date can be derived from the production batch on the item. Example: A18 FD7-411. The batch's first letter refers to the month of manufacture (A=January, B=February, etc.) The second and third letters refer to the year of manufacture (18 =2018, 19=2019, etc...)

## Features

The contact blocks developed by Pizzato Elettrica are the result of more than 30 years of development experience and millions of sold switches. The range of available contact blocks is one of the most extensive in the world in the sector of position switches.

This chapter introduces to some features of Pizzato Elettrica contact blocks, in order to give the final user a better understanding of the technologies behind that element simply named "contact".

We underline that contact blocks are not available for sale (to the public) separately from switches, both because some of them are mechanically connected to the switch and because some technical features may change in accordance with the switch and its function. The following data is only intended to serve as an aid for the initial selection of the contact block. It is not to be used for determining the characteristics of the switch that uses this contact block. For example, the use of a contact block with positive opening with a switch with flexible actuator results in the combination of the two devices not having positive opening.

In this chapter, the properties of the E1 electronic contact block are explained in detail. It is used with position switches with multiple monitoring tasks that would require extensive effort to realize with electronic sensors. There is no other electronic sensor on the market that can match this contact unit with respect to precision and repeatability, adjustment of the switching point, operating temperature and price.

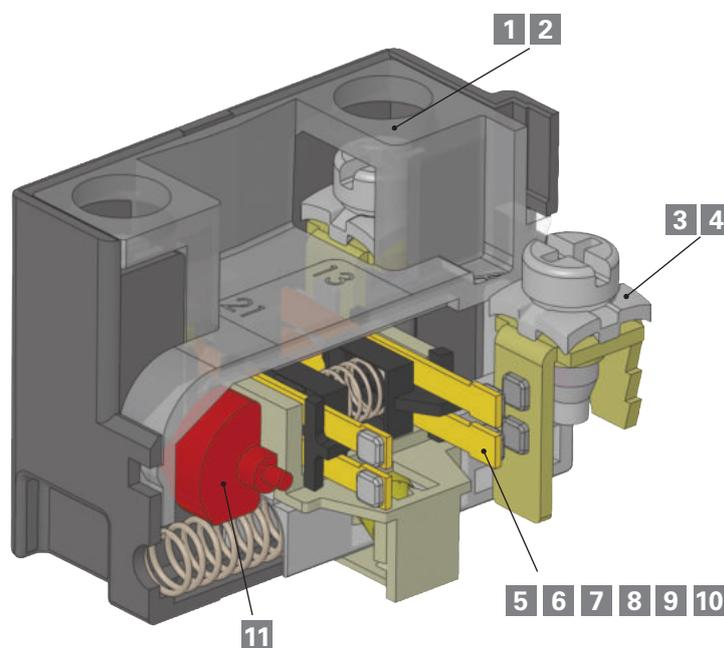

### Description

- 1** Captive screws
- 2** Finger protection
- 3** Clamping screw plates for cables with various diameters
- 4** Self-lifting clamping screw plates
- 5** Material of the contacts: Silver alloy or gold-plated silver alloy
- 6** Contact technology and reliability: Single bridge, double bridge
- 7** Operating voltages and currents for reliable switching

### Description

- 8** Classification of the contact design acc. to EN 60947-5-1: X, Y, C, Za, Zb
- 9** Contact type: Slow action / snap action / snap action with constant pressure
- 10** Force on contacts
- 11** Positive opening of contacts



### 1 Captive screws

Switches with this characteristic have clamping screws that remain in place even if completely unscrewed. This feature reduces wiring time, since the operator does not have to be careful not to unscrew the screws completely and does not risk to lose them by mistake, which is very useful in case of wirings in uncomfortable position

### 2 Finger protection

All terminals in the contact blocks have protection degree IP20 in accordance with EN 60529, they are therefore protected against access to dangerous parts with a diameter greater than 12 mm.

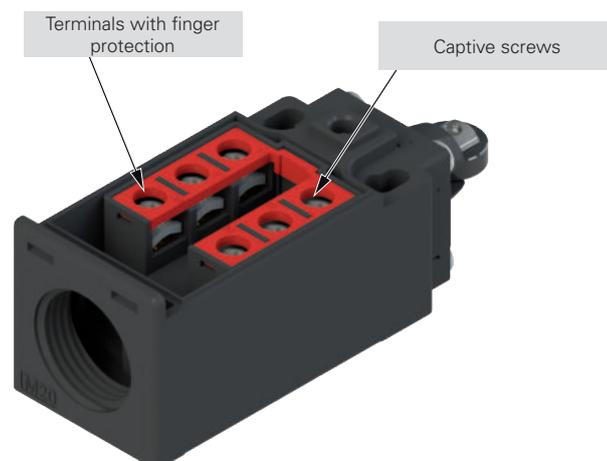

### 3 Clamping screw plates for cables with various diameters

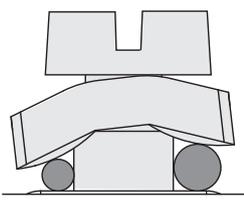

The clamping screw plates are provided with a particular "roofing tile" structure and are loosely coupled to the clamping screw. The design causes connection wires of different diameter to be pulled towards the screw when tightening the screw (see figure), preventing the wires from escaping towards the outside.

### 4 Self-lifting clamping screw plates

Switches with this feature are equipped with clamping screw plates that move up or down by turning the clamping screw; wiring is easier and faster as a result.

### 5 Contact material: gold-plated silver alloy

The contact blocks can be supplied with silver electric contacts with a special gold-plated surface, with total gold thickness of one micron. This type of treatment can be useful in environments which are aggressive against silver (very humid or sulphurous atmospheres) and in case of very small electric loads, usually with low voltages and supply currents. This thickness of the gold coating permits several million switching cycles.

## 6 Contact technology and reliability

Very rarely, an electric contact does not function. A failed switching operation is a typical consequence of an exceptionally high contact resistance caused by dust, a thin layer of oxidation or other impurities that could penetrate the switch during wiring. Thus, the repeated occurrence of faulty switching depends not only on the sensor type, but also on its environmental conditions and the load that the switch drives. These effects are more evident with low electrical loads if the electric voltage cannot penetrate the thin layers of oxide or small grains of dust.

This type of malfunction can normally be tolerated with hand-operated devices, because repeating the operation is enough to restore the function. This is not the case with position switches, as severe machine damage could result if the end position is not ascertained.

In the following table we refer to two typical contact structures (type A and B) normally used in the industry and the ones which have been used by Pizzato Elettrica for several years in most switches: movable contacts with double interruption and twin bridge (type C).

As you can see from the table below, the last structure (type C) has the same contact resistance (**R**) as the simple mobile contact (type A), but with a lower failure probability (**fe**).

With a failure probability of **x** for a single switching operation, the failure probability for type A is **fe=x**, for type B **fe 2·x**, whereas for type C it is **fe 4·x<sup>2</sup>**

This means that if the probability of a switching failure is **x** in a given situation, e.g.,  $1 \times 10^{-4}$ , (1 switching failure in 10,000), the result is as follows:

- for type A one failed commutation every 10,000.
- for type B one failed commutation every 5,000.
- for type C one failed commutation every 25,000,000.

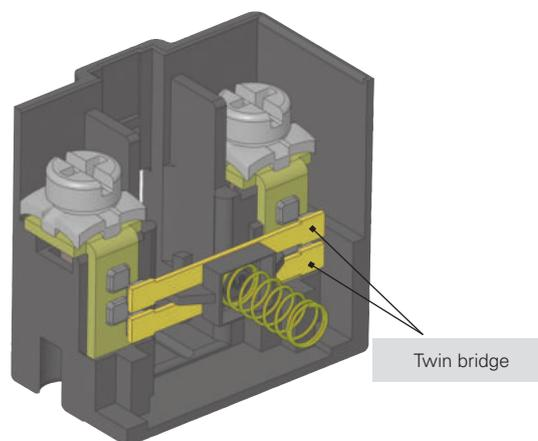

Type	Diagram	Description	Contact resistance R	Probability of errors fe
A		simple mobile contact	$R=R_c$	$fe=x$
B		mobile contact with double interruption	$R=2 \cdot R_c$	$fe=2x-x^2$
C		mobile contact with double interruption and twin bridge	$R= \frac{2 \cdot R_c^2}{R_c} = R_c$	$fe=4x^2-4x^3+x^4$

## 7 Minimum operating voltages and currents for reliable switching

The reliability of an electric contact depends on several factors, whose influence varies depending on the type of load. For high power loads is necessary for the contact to be able to dissipate the heat generated during switching. For low power loads, instead, it is important that it oxides and other impurities do not obstruct the passing of the electric signal. As a result, the material chosen for the electric contacts is a compromise among different and sometimes contrasting needs. In position switches contacts are usually made of a silver that has proved to be suitable for the switching of loads in the range of approximately 1 kW to 0.1 W. However, at lower loads, the effects of the oxide, which silver naturally develops upon contact with air, may occur; additionally to be taken into account are possible contaminations or impurities in the contact switching chamber (for example the talc powder in the cable sheaths that an installer could accidentally insert in the switch may have a similar effect).

It is impossible to define a fix threshold above which the "missing switching phenomenon" does not appear, because there are a lot of mechanical and electric parameters that influence this value. For example, in laboratory environment a good twin bridge electric contact is able to switch loads in the  $\mu\text{W}$  range for dozens of millions of handling operations, without losing signals. However, this does not mean that the same contact will have the same performance when the switch operates in environments with sudden changes of temperature (condensation) or where few switching occur (oxidation).

In order to avoid this kind of problem, gold plated contacts are used for very low loads profiting from the non-oxidability of this material. The gold-plating layer should be thick enough to be mechanically resistant to switching as well as electrically resistant to possible sparks that may vaporize it. For this reason Pizzato Elettrica uses micron thickness gold plating suitable for millions of working cycles. Thinner gold plating layers have often a purely aesthetic function and are only suitable to protect the product against oxidation during long time storage.

The minimum current and voltage values recommended by Pizzato Elettrica are shown in the diagram below, that is divided into two areas defined by a steady power limit. These values identify voltage and current combinations with high commutation reliability in most industrial fields. The lower voltage and current limits shown in the diagram are typical minimum values for industrial applications. They may also be reduced in non typical conditions. It is recommended, however, to always evaluate that the signal power to be switched is at least one magnitude order higher than the noise produced in the electric circuit, in particular when circuit cables are long and pass through areas with high electromagnetic fields and especially for powers lower than 10 mW.

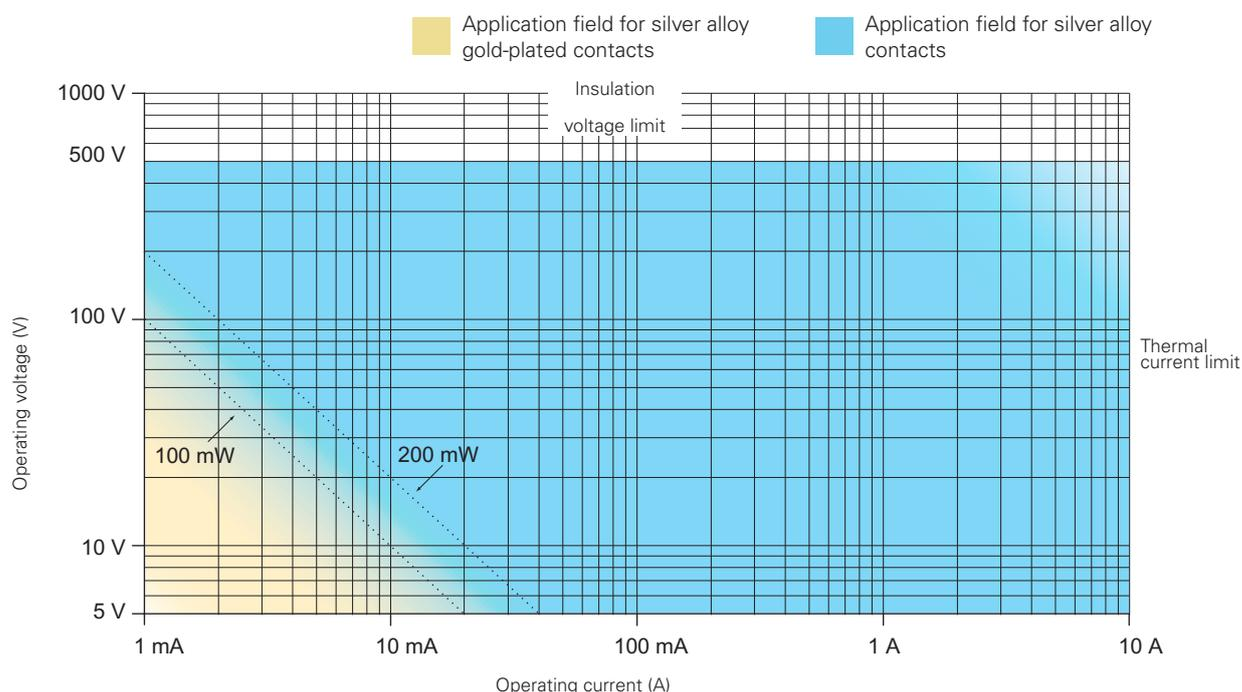

**100 mW** Suggested limit for general applications with snap action contact blocks with silver alloy contacts.

**200 mW** Recommended limit for general applications with slow action contact blocks with silver alloy contacts.

## 8 Classification of the contact block acc. to the EN 60947-5-1

Design	Figure	Symbol	Description
X			Double interruption contact element with two terminals
Y			Change-over contact element with single interruption and three terminals
Za			Change-over contact element with double interruption and four terminals. <b>The contacts have identical polarity</b>
Zb			Change-over contact element with double interruption and four terminals. <b>Mobile contacts are electrically separated</b>

## Electrically separated contacts

The “+” symbol between two designs (e.g., X+X, Za+Za, X+X+Y, etc.) represents the combination of simple, **electrically separated** contact blocks.

The electrically separated contacts allow different voltages to be applied between the contacts and loads to be connected to different polarities (figure 1).

## Requirements and restrictions for Za contacts

Electrical loads must be connected to the same phase or polarity. The contacts **are not** electrically separated. As a result, different voltages may not be applied to the NC and NO contacts (figures 2 and 3).

According to EN 60947-5-1 section K.7.1.4.6.1, the following restrictions apply for positive opening contacts of design Za when used for safety applications.

When the control switch has form C or form Za change-over contact elements, **only one contact element shall be used** (make or break). In the case of form Zb change-over contact elements, both contacts may be used.

## Contact design Zb

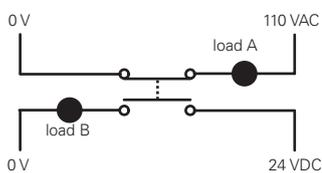

figure 1: correct

## Contact design Za

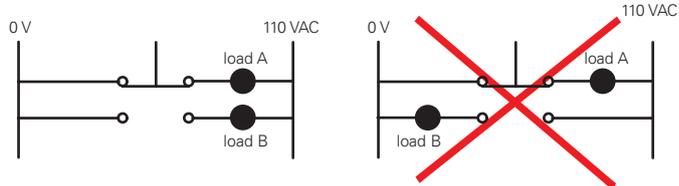

figure 2: correct

figure 3: incorrect

**9 Contact blocks with different operating principle: slow action and snap action**

**Contact blocks with slow action:** component where the speed of the contact movement (**V1**) depends on the speed of the switch actuation (**V**). The contact carrier moves at a rate proportional to the actuation speed.

The slow action contact block is suitable for applications having low to medium currents and quick actuation movements. It has no differential travel.

$$V = V1$$

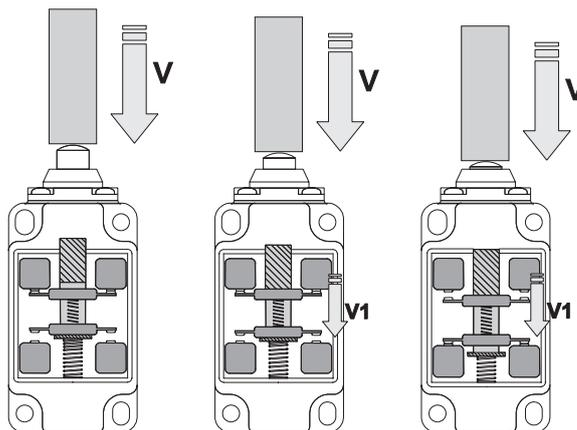

**Contact block with snap action:** component where the speed of the contact movement (**V1**) doesn't depend on the speed of the switch actuation (**V**). Upon reaching a predetermined point in the actuation travel, the contact carrier triggers and switches the contacts.

The snap action contact block is suitable for applications having high currents and/or slow actuation movements. This kind of contact block has a differential travel.

$$V \neq V1$$

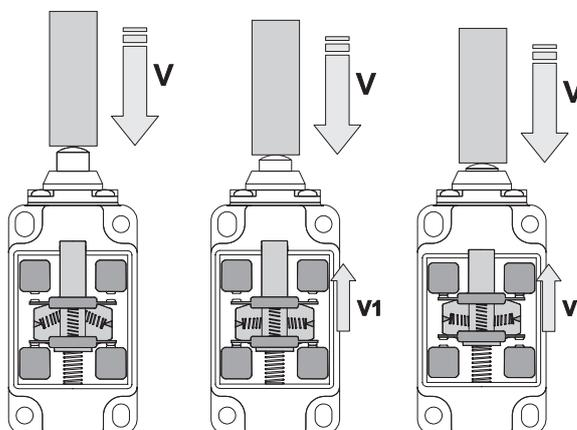

**10 Contact blocks: diagrams of the force on the contacts**

The following diagrams show the relationship between of the force exerted on the contacts (**F**) and the actuation travel to the end position.

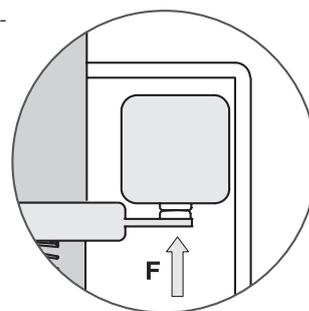
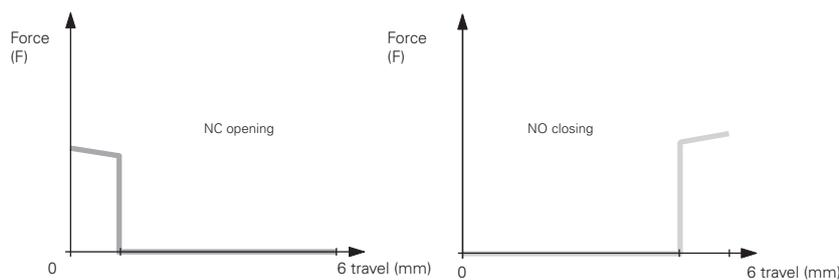

**Contact block with slow action**

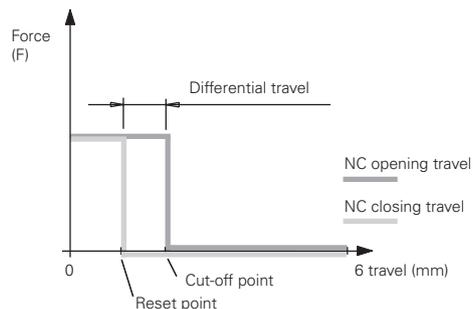

**Contact block with snap action and constant pressure:** 5, 11, 12.  
The pressure on the contacts remains constant as the switching point is approached

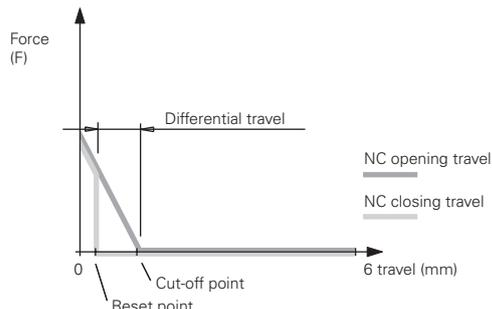

**Contact block with snap action:** 2, 3, 17  
The pressure on the contacts decreases as the switching point is approached

Contact blocks of the FD-FP-FL-FC-FR-FM-FX-FZ-FK-FW-FS series

Contact block	Contact diagram	Linear travel diagram	Contact design	Operation type	Positive opening ☹	Contact type	Wire cross-section min. max.	Wire stripping length	Captive screws	Terminals with finger protection	Gold-plated contacts
2 2x (1NO-1NC)			Za+Za	snap action	no	Double interruption	1 x 0.5 mm <sup>2</sup> 1 x AWG 20 2 x 1.5 mm <sup>2</sup> 2 x AWG 16	6 mm	no	no	G
3 1NO-1NC			Za	snap action	no	Double interruption	1 x 0.5 mm <sup>2</sup> 1 x AWG 20 2 x 2.5 mm <sup>2</sup> 2 x AWG 14	6 mm	no	no	G
5 1NO+1NC			Zb	snap action	yes	Double interruption, twin bridge	1 x 0.5 mm <sup>2</sup> 1 x AWG 20 2 x 2.5 mm <sup>2</sup> 2 x AWG 14	8 mm	yes	yes	G / G1
6 1NO+1NC			Zb	slow action	yes	Double interruption, twin bridge	1 x 0.5 mm <sup>2</sup> 1 x AWG 20 2 x 2.5 mm <sup>2</sup> 2 x AWG 14	8 mm	yes	yes	G / G1
7 1NO+1NC			Zb	slow action	yes	Double interruption, twin bridge	1 x 0.5 mm <sup>2</sup> 1 x AWG 20 2 x 2.5 mm <sup>2</sup> 2 x AWG 14	8 mm	yes	yes	G / G1
8 1NC			Y	slow action	yes	Double interruption, twin bridge	1 x 0.5 mm <sup>2</sup> 1 x AWG 20 2 x 2.5 mm <sup>2</sup> 2 x AWG 14	8 mm	yes	yes	G / G1
9 2NC			Y+Y	slow action	yes	Double interruption, twin bridge	1 x 0.5 mm <sup>2</sup> 1 x AWG 20 2 x 2.5 mm <sup>2</sup> 2 x AWG 14	8 mm	yes	yes	G / G1
10 2NO			X+X	slow action	no	Double interruption, twin bridge	1 x 0.5 mm <sup>2</sup> 1 x AWG 20 2 x 2.5 mm <sup>2</sup> 2 x AWG 14	8 mm	yes	yes	G / G1
11 2NC			Y+Y	snap action	yes	Double interruption, twin bridge	1 x 0.5 mm <sup>2</sup> 1 x AWG 20 2 x 2.5 mm <sup>2</sup> 2 x AWG 14	8 mm	yes	yes	G / G1
12 2NO			X+X	snap action	no	Double interruption, twin bridge	1 x 0.5 mm <sup>2</sup> 1 x AWG 20 2 x 2.5 mm <sup>2</sup> 2 x AWG 14	8 mm	yes	yes	G / G1
13 2NC			Y+Y	slow action	yes	Double interruption, twin bridge	1 x 0.5 mm <sup>2</sup> 1 x AWG 20 2 x 2.5 mm <sup>2</sup> 2 x AWG 14	8 mm	yes	yes	G / G1
14 2NC			Y+Y	slow action	yes	Double interruption, twin bridge	1 x 0.5 mm <sup>2</sup> 1 x AWG 20 2 x 2.5 mm <sup>2</sup> 2 x AWG 14	8 mm	yes	yes	G / G1
15 2NO			X+X	slow action	no	Double interruption, twin bridge	1 x 0.5 mm <sup>2</sup> 1 x AWG 20 2 x 2.5 mm <sup>2</sup> 2 x AWG 14	8 mm	yes	yes	G / G1
16 2NC			Y+Y	slow action	yes	Double interruption, twin bridge	1 x 0.5 mm <sup>2</sup> 1 x AWG 20 2 x 2.5 mm <sup>2</sup> 2 x AWG 14	8 mm	yes	yes	G / G1
18 1NO+1NC			Zb	slow action	yes	Double interruption, twin bridge	1 x 0.5 mm <sup>2</sup> 1 x AWG 20 2 x 2.5 mm <sup>2</sup> 2 x AWG 14	8 mm	yes	yes	G / G1
20 1NO+2NC			Y+Y+X	slow action	yes	Double interruption, twin bridge	1 x 0.34 mm <sup>2</sup> 1 x AWG 22 2 x 1.5 mm <sup>2</sup> 2 x AWG 16	7 mm	yes	yes	G
21 3NC			Y+Y+Y	slow action	yes	Double interruption, twin bridge	1 x 0.34 mm <sup>2</sup> 1 x AWG 22 2 x 1.5 mm <sup>2</sup> 2 x AWG 16	7 mm	yes	yes	G
22 2NO+1NC			Y+X+X	slow action	yes	Double interruption, twin bridge	1 x 0.34 mm <sup>2</sup> 1 x AWG 22 2 x 1.5 mm <sup>2</sup> 2 x AWG 16	7 mm	yes	yes	G
28 1NO+2NC			Y+Y+X	slow action	yes	Double interruption, twin bridge	1 x 0.34 mm <sup>2</sup> 1 x AWG 22 2 x 1.5 mm <sup>2</sup> 2 x AWG 16	7 mm	yes	yes	G
29 3NC			Y+Y+Y	slow action	yes	Double interruption, twin bridge	1 x 0.34 mm <sup>2</sup> 1 x AWG 22 2 x 1.5 mm <sup>2</sup> 2 x AWG 16	7 mm	yes	yes	G
30 3NC			Y+Y+Y	slow action	yes	Double interruption, twin bridge	1 x 0.34 mm <sup>2</sup> 1 x AWG 22 2 x 1.5 mm <sup>2</sup> 2 x AWG 16	7 mm	yes	yes	G
33 1NO+1NC			Zb	slow action	yes	Double interruption, twin bridge	1 x 0.34 mm <sup>2</sup> 1 x AWG 22 2 x 1.5 mm <sup>2</sup> 2 x AWG 16	7 mm	yes	yes	G
34 2NC			Y+Y	slow action	yes	Double interruption, twin bridge	1 x 0.34 mm <sup>2</sup> 1 x AWG 22 2 x 1.5 mm <sup>2</sup> 2 x AWG 16	7 mm	yes	yes	G
37 1NO+1NC			Zb	slow action	yes	Double interruption, twin bridge	1 x 0.5 mm <sup>2</sup> 1 x AWG 20 2 x 2.5 mm <sup>2</sup> 2 x AWG 14	8 mm	yes	yes	G / G1
66 1NC			Y	slow action	yes	Double interruption, twin bridge	1 x 0.5 mm <sup>2</sup> 1 x AWG 20 2 x 2.5 mm <sup>2</sup> 2 x AWG 14	8 mm	yes	yes	G / G1
67 1NO			X	slow action	no	Double interruption, twin bridge	1 x 0.5 mm <sup>2</sup> 1 x AWG 20 2 x 2.5 mm <sup>2</sup> 2 x AWG 14	8 mm	yes	yes	G / G1
E1 1NO-1NC			PNP	electronic	no	Electronic	1 x 0.5 mm <sup>2</sup> 1 x AWG 20 1 x 1.5 mm <sup>2</sup> 1 x AWG 16	7 mm	no	no	/

Legend: G = gold-plated contacts 1 µm, G1 = gold-plated contacts 2.5 µm

Contact blocks - FG series

Contact block	Contact diagram	Linear travel diagram	Contact design	Operation type	Positive opening ☹	Contact type	Wire cross-section min. max.	Wire stripping length	Captive screws	Terminals with finger protection	Gold-plated contacts
60•	Contact block with 4 poles and multiple contact designs. See page 107, General Catalogue Safety 2019-2020			Slow action	yes	Double interruption, twin bridge and double contact point	1 x 0.34 mm <sup>2</sup> 1 x AWG 22 2 x 1.5 mm <sup>2</sup> 2 x AWG 16	7 mm	yes	yes	G

## Contact blocks - NA-NB-NF series

Contact block	Contact diagram	Linear travel diagram	Contact design	Operation type	Positive opening 	Contact type	Captive screws	Terminals with finger protection	Gold-plated contacts	
B11	1NO+1NC			Zb	snap action	yes	Double interruption	/	/	G
B02	2NC			Y+Y	snap action	yes	Double interruption	/	/	G
B12	1NO+2NC			X+Y+Y	snap action	yes	Double interruption	/	/	G
B22	2NO+2NC			X+X+Y+Y	snap action	yes	Double interruption	/	/	G
G11	1NO+1NC			Zb	slow action	yes	Double interruption	/	/	G
G02	2NC			Y+Y	slow action	yes	Double interruption	/	/	G
G12	1NO+2NC			X+Y+Y	slow action	yes	Double interruption	/	/	G
G22	2NO+2NC			X+X+Y+Y	slow action	yes	Double interruption	/	/	G
H11	1NO+1NC			Zb	slow action	yes	Double interruption	/	/	G
H12	1NO+2NC			X+Y+Y	slow action	yes	Double interruption	/	/	G
H22	2NO+2NC			X+X+Y+Y	slow action	yes	Double interruption	/	/	G
L11	1NO+1NC			Zb	slow action	yes	Double interruption	/	/	G
L12	1NO+2NC			X+Y+Y	slow action	yes	Double interruption	/	/	G
L22	2NO+2NC			X+X+Y+Y	slow action	yes	Double interruption	/	/	G
BA1	1NO+1NC change-over			C	snap action	yes	Double interruption	/	/	G

## Contact blocks - HP series

Contact block	Contact diagram	Linear travel diagram	Contact design	Operation type	Positive opening 	Contact type	Captive screws	Terminals with finger protection	Gold-plated contacts
50C	1NO+1NC		Zb	snap action	yes	Double interruption	/	/	G
50D	2NC		Y+Y	snap action	yes	Double interruption	/	/	G
50F	1NO+2NC		X+Y+Y	snap action	yes	Double interruption	/	/	G
50M	2NO+2NC		X+X+Y+Y	snap action	yes	Double interruption	/	/	G
52C	1NO+1NC		Zb	slow action	yes	Double interruption	/	/	G
52D	2NC		Y+Y	slow action	yes	Double interruption	/	/	G
52F	1NO+2NC		X+Y+Y	slow action	yes	Double interruption	/	/	G
52M	2NO+2NC		X+X+Y+Y	slow action	yes	Double interruption	/	/	G
53C	1NO+1NC		Zb	slow action	yes	Double interruption	/	/	G
53F	1NO+2NC		X+Y+Y	slow action	yes	Double interruption	/	/	G
53M	2NO+2NC		X+X+Y+Y	slow action	yes	Double interruption	/	/	G

**Wiring diagram for assembled connectors**

**For FD - FL - FM - FZ - FC series with metal housing**

Contact block 2 2x(1NO+1NC)	Contact block 5 1NO+1NC	Contact block 6 1NO+1NC	Contact block 7 1NO+1NC	Contact block 9 2NC	Contact block 10 2NO	Contact block 11 2NC	Contact block 12 2NO	Contact block 13 2NC
M12 connector, 8-pole	M12 connector, 5-pole	M12 connector, 5-pole	M12 connector, 5-pole	M12 connector, 5-pole	M12 connector, 5-pole	M12 connector, 5-pole	M12 connector, 5-pole	M12 connector, 5-pole
<b>Contacts Pin no.</b>	<b>Contacts Pin no.</b>	<b>Contacts Pin no.</b>	<b>Contacts Pin no.</b>	<b>Contacts Pin no.</b>	<b>Contacts Pin no.</b>	<b>Contacts Pin no.</b>	<b>Contacts Pin no.</b>	<b>Contacts Pin no.</b>
NO 3-4	NC 1-2	NC 1-2	NC 1-2	NC 1-2	NO 1-2	NC 1-2	NO 1-2	NC (1°) 1-2
NC 5-6	NO 3-4	NO 3-4	NO 3-4	NC 3-4	NO 3-4	NC 3-4	NO 3-4	NC (2°) 3-4
NC 7-8	ground 5	ground 5	ground 5	ground 5	ground 5	ground 5	ground 5	ground 5
NO 1-2								

Contact block 14 2NC	Contact block 15 2NO	Contact block 16 2NC	Contact block 18 1NO+1NC	Contact block 20 1NO+2NC	Contact block 21 3NC	Contact block 22 2NO+1NC	Contact block 33 1NO+1NC	Contact block 34 2NC
M12 connector, 5-pole	M12 connector, 5-pole	M12 connector, 5-pole	M12 connector, 5-pole	M12 connector, 8-pole	M12 connector, 8-pole	M12 connector, 8-pole	M12 connector, 5-pole	M12 connector, 5-pole
<b>Contacts Pin no.</b>	<b>Contacts Pin no.</b>	<b>Contacts Pin no.</b>	<b>Contacts Pin no.</b>	<b>Contacts Pin no.</b>	<b>Contacts Pin no.</b>	<b>Contacts Pin no.</b>	<b>Contacts Pin no.</b>	<b>Contacts Pin no.</b>
NC (1°) 1-2	NO (1°) 1-2	NC, lever to the right 1-2	NC 1-2	NC 3-4	NC 3-4	NC 3-4	NC 1-2	NC 1-2
NC (2°) 3-4	NO (2°) 3-4	NC, lever to the left 3-4	NO 3-4	NC 5-6	NC 5-6	NO 5-6	NO 3-4	NC 3-4
ground 5	ground 5	ground 5	ground 5	NO 7-8	NC 7-8	NO 7-8	ground 5	ground 5
				ground 1	ground 1	ground 1		

Contact block 28 1NO+2NC	Contact block 29 3NC	Contact block 30 3NC	Contact block E1 PNP
M12 connector, 8-pole	M12 connector, 8-pole	M12 connector, 8-pole	M12 connector, 5-pole
<b>Contacts Pin no.</b>	<b>Contacts Pin no.</b>	<b>Contacts Pin no.</b>	<b>Contacts Pin no.</b>
NC  3-4	NC  3-4	NC  3-4	+ 1
NC  5-6	NC  5-6	NC  5-6	- 3
NO  7-8	NC  7-8	NC  7-8	NC 2
ground 1	ground 1	ground 1	NO 4
			ground 5

**For FS series with technopolymer housing**

Contact block 18 1NO+1NC	Contact block 20 1NO+2NC	Contact block 21 3NC	Contact block 28 1NO+2NC	Contact block 29 3NC	Contact block 30 3NC
M12 connector, 8-pole	M12 connector, 8-pole	M12 connector, 8-pole	M12 connector, 8-pole	M12 connector, 8-pole	M12 connector, 8-pole
<b>Contacts Pin no.</b>	<b>Contacts Pin no.</b>	<b>Contacts Pin no.</b>	<b>Contacts Pin no.</b>	<b>Contacts Pin no.</b>	<b>Contacts Pin no.</b>
A1-A2 1-2	A1-A2 1-2	A1-A2 1-2	A1-A2 1-2	A1-A2 1-2	A1-A2 1-2
NC  3-4	NC  3-4	NC  3-4	NC  3-4	NC  3-4	NC  3-4
NO  5-6	NC  5-6	NC  5-6	NC  5-6	NC  5-6	NC  5-6
	NO  7-8	NC  7-8	NO  7-8	NC  7-8	NC  7-8



### Wiring diagram for assembled connectors

For FP - FR - FX - FW series with technopolymer housing

Contact block 2 2x(1NO-1NC)	Contact block 5 1NO+1NC	Contact block 6 1NO+1NC	Contact block 7 1NO+1NC	Contact block 9 2NC	Contact block 10 2NO	Contact block 11 2NC	Contact block 12 2NO	Contact block 13 2NC	
M12 connector, 8-pole	M12 connector, 4-pole	M12 connector, 4-pole	M12 connector, 4-pole	M12 connector, 4-pole	M12 connector, 4-pole	M12 connector, 4-pole	M12 connector, 4-pole	M12 connector, 4-pole	
Contacts	Pin no.	Contacts	Pin no.	Contacts	Pin no.	Contacts	Pin no.	Contacts	Pin no.
NO	3-4	NC	1-2	NC	1-2	NC	1-2	NO	1-2
NC	5-6	NO	3-4	NO	3-4	NO	3-4	NC	3-4
NC	7-8								
NO	1-2								

Contact block 14 2NC	Contact block 15 2NO	Contact block 16 2NC	Contact block 18 1NO+1NC	Contact block 20 1NO+2NC	Contact block 21 3NC	Contact block 22 2NO+1NC	Contact block 33 1NO+1NC	Contact block 34 2NC	
M12 connector, 4-pole	M12 connector, 4-pole	M12 connector, 4-pole	M12 connector, 4-pole	M12 connector, 8-pole	M12 connector, 8-pole	M12 connector, 8-pole	M12 connector, 4-pole	M12 connector, 4-pole	
Contacts	Pin no.	Contacts	Pin no.	Contacts	Pin no.	Contacts	Pin no.	Contacts	Pin no.
NC (1°)	1-2	NO (1°)	1-2	NC, lever to the right	1-2	NC	3-4	NC	1-2
NC (2°)	3-4	NO (2°)	3-4	NC, lever to the left	3-4	NO	5-6	NO	3-4
						NO	7-8	NC	3-4

Contact block 28 1NO+2NC	Contact block 29 3NC	Contact block 30 3NC	Contact block E1 PNP		
M12 connector, 8-pole	M12 connector, 8-pole	M12 connector, 8-pole	M12 connector, 4-pole		
Contacts	Pin no.	Contacts	Pin no.	Contacts	Pin no.
NC	3-4	NC	3-4	+	1
NC	5-6	NC	5-6	-	3
NO	7-8	NC	7-8	NC	2
				NO	4

## For FG series with metal housing and M23 connector

Contact block 60A 2NO+2NC	Contact block 60B 1NO+3NC	Contact block 60C 4NC	Contact block 60D 1NO+3NC	Contact block 60E 1NO+3NC	Contact block 60F 2NO+2NC	Contact block 60G 4NC	Contact block 60H 4NC	Contact block 60I 1NO+3NC	Contact block 60L 2NO+2NC
---------------------------------	---------------------------------	-----------------------------	---------------------------------	---------------------------------	---------------------------------	-----------------------------	-----------------------------	---------------------------------	---------------------------------



M23 connector, 12-pole

Contact	Pin no.	Contact	Pin no.	Contact	Pin no.	Contact	Pin no.	Contact	Pin no.	Contact	Pin no.	Contact	Pin no.	Contact	Pin no.	Contact	Pin no.	Contact	Pin no.	Contact	Pin no.		
A1-A2	1-2	A1-A2	1-2	A1-A2	1-2	A1-A2	1-2	A1-A2	1-2	A1-A2	1-2	A1-A2	1-2	A1-A2	1-2	A1-A2	1-2	A1-A2	1-2	A1-A2	1-2	A1-A2	1-2
NC	3-4	NC	3-4	NC	3-4	NO	3-4	NC	3-4	NC	3-4	NC	3-4	NC	3-4	NC	3-4	NC	3-4	NC	3-4	NC	3-4
NC	5-6	NC	5-6	NC	5-6	NC	5-6	NC	5-6	NC	5-6	NC	5-6	NC	5-6	NC	5-6	NC	5-6	NC	5-6	NC	5-6
NO	7-8	NC	7-8	NC	7-8	NC	7-8	NC	7-8	NO	7-8	NC	7-8	NC	7-8	NC	7-8	NC	7-8	NC	7-8	NO	7-8
NO	9-10	NO	9-10	NC	9-10	NC	9-10	NO	9-10	NO	9-10	NC	9-10	NC	9-10	NO	9-10	NO	9-10	NO	9-10	NO	9-10
ground	11	ground	11	ground	11	ground	11	ground	11	ground	11	ground	11	ground	11	ground	11	ground	11	ground	11	ground	11

Contact block 60M 3NO+1NC	Contact block 60N 3NO+1NC	Contact block 60P 4NC	Contact block 60R 2NO+2NC	Contact block 60S 2NO+2NC	Contact block 60T 1NO+3NC	Contact block 60U 4NC	Contact block 60V 2NO+2NC	Contact block 60X 1NO+3NC	Contact block 60Y 2NO+2NC
---------------------------------	---------------------------------	-----------------------------	---------------------------------	---------------------------------	---------------------------------	-----------------------------	---------------------------------	---------------------------------	---------------------------------

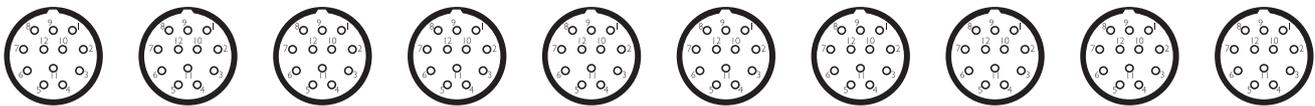

M23 connector, 12-pole

Contact	Pin no.	Contact	Pin no.	Contact	Pin no.	Contact	Pin no.	Contact	Pin no.	Contact	Pin no.	Contact	Pin no.	Contact	Pin no.	Contact	Pin no.	Contact	Pin no.	Contact	Pin no.	Contact	Pin no.
A1-A2	1-2	A1-A2	1-2	A1-A2	1-2	A1-A2	1-2	A1-A2	1-2	A1-A2	1-2	A1-A2	1-2	A1-A2	1-2	A1-A2	1-2	A1-A2	1-2	A1-A2	1-2	A1-A2	1-2
NO	3-4	NO	3-4	NC	3-4	NC	3-4	NC	3-4	NC	3-4	NC	3-4	NC	3-4	NO	3-4	NC	3-4	NC	3-4	NC	3-4
NC	5-6	NC	5-6	NC	5-6	NC	5-6	NC	5-6	NC	5-6	NC	5-6	NC	5-6	NC	5-6	NC	5-6	NC	5-6	NC	5-6
NO	7-8	NO	7-8	NC	7-8	NO	7-8	NC	7-8	NC	7-8	NC	7-8	NO	7-8	NC	7-8	NC	7-8	NO	7-8	NC	7-8
NO	9-10	NO	9-10	NC	9-10	NO	9-10	NO	9-10	NO	9-10	NC	9-10	NO	9-10	NC	9-10	NC	9-10	NO	9-10	NC	9-10
ground	11	ground	11	ground	11	ground	11	ground	11	ground	11	ground	11	ground	11	ground	11	ground	11	ground	11	ground	11

Contact block 61A 1NO+3NC	Contact block 61B 2NO+2NC	Contact block 61C 3NO+1NC	Contact block 61D 3NO+1NC	Contact block 61E 3NO+1NC	Contact block 61G 3NO+1NC	Contact block 61H 2NO+2NC	Contact block 61M 3NO+1NC	Contact block 61R 1NO+3NC	Contact block 61S 3NO+1NC
---------------------------------	---------------------------------	---------------------------------	---------------------------------	---------------------------------	---------------------------------	---------------------------------	---------------------------------	---------------------------------	---------------------------------

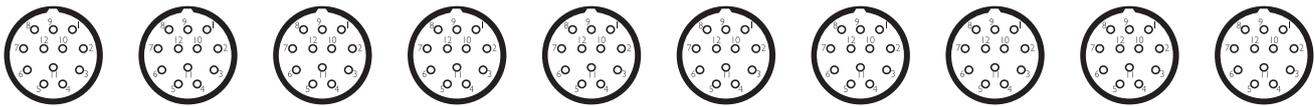

M23 connector, 12-pole

Contact	Pin no.	Contact	Pin no.	Contact	Pin no.	Contact	Pin no.	Contact	Pin no.	Contact	Pin no.	Contact	Pin no.	Contact	Pin no.	Contact	Pin no.	Contact	Pin no.	Contact	Pin no.	Contact	Pin no.
A1-A2	1-2	A1-A2	1-2	A1-A2	1-2	A1-A2	1-2	A1-A2	1-2	A1-A2	1-2	A1-A2	1-2	A1-A2	1-2	A1-A2	1-2	A1-A2	1-2	A1-A2	1-2	A1-A2	1-2
NC	3-4	NC	3-4	NO	3-4	NO	3-4	NO	3-4	NC	3-4	NC	3-4	NO	3-4	NC	3-4	NC	3-4	NO	3-4	NC	3-4
NC	5-6	NC	5-6	NC	5-6	NC	5-6	NC	5-6	NC	5-6	NC	5-6	NC	5-6	NC	5-6	NC	5-6	NC	5-6	NC	5-6
NC	7-8	NO	7-8	NO	7-8	NO	7-8	NO	7-8	NO	7-8	NO	7-8	NO	7-8	NO	7-8	NC	7-8	NO	7-8	NO	7-8
NO	9-10	NO	9-10	NO	9-10	NO	9-10	NO	9-10	NO	9-10	NO	9-10	NO	9-10	NO	9-10	NO	9-10	NO	9-10	NO	9-10
ground	11	ground	11	ground	11	ground	11	ground	11	ground	11	ground	11	ground	11	ground	11	ground	11	ground	11	ground	11

For FG series with metal housing and M12 connector

Contact block 60A 2NO+2NC	Contact block 60B 1NO+3NC	Contact block 60C 4NC	Contact block 60D 1NO+3NC	Contact block 60E 1NO+3NC	Contact block 60F 2NO+2NC	Contact block 60G 4NC	Contact block 60H 4NC	Contact block 60I 1NO+3NC	Contact block 60L 2NO+2NC
M12 connector, 12-pole	M12 connector, 12-pole	M12 connector, 12-pole	M12 connector, 12-pole	M12 connector, 12-pole	M12 connector, 12-pole	M12 connector, 12-pole	M12 connector, 12-pole	M12 connector, 12-pole	M12 connector, 12-pole
Contacts Pin no.	Contacts Pin no.	Contacts Pin no.	Contacts Pin no.	Contacts Pin no.	Contacts Pin no.	Contacts Pin no.	Contacts Pin no.	Contacts Pin no.	Contacts Pin no.
A1-A2 1-2	A1-A2 1-2	A1-A2 1-2	A1-A2 1-2	A1-A2 1-2	A1-A2 1-2	A1-A2 1-2	A1-A2 1-2	A1-A2 1-2	A1-A2 1-2
NC	NC	NC	NO	NC	NC	NC	NC	NC	NC
NC	NC	NC	NC	NC	NC	NC	NC	NC	NC
NO	NC	NC	NC	NC	NO	NC	NC	NC	NO
NO	NO	NC	NC	NO	NO	NC	NC	NO	NO

Contact block 60M 3NO+1NC	Contact block 60N 3NO+1NC	Contact block 60P 4NC	Contact block 60R 2NO+2NC	Contact block 60S 2NO+2NC	Contact block 60T 1NO+3NC	Contact block 60U 4NC	Contact block 60V 2NO+2NC	Contact block 60X 1NO+3NC	Contact block 60Y 2NO+2NC
M12 connector, 12-pole	M12 connector, 12-pole	M12 connector, 12-pole	M12 connector, 12-pole	M12 connector, 12-pole	M12 connector, 12-pole	M12 connector, 12-pole	M12 connector, 12-pole	M12 connector, 12-pole	M12 connector, 12-pole
Contacts Pin no.	Contacts Pin no.	Contacts Pin no.	Contacts Pin no.	Contacts Pin no.	Contacts Pin no.	Contacts Pin no.	Contacts Pin no.	Contacts Pin no.	Contacts Pin no.
A1-A2 1-2	A1-A2 1-2	A1-A2 1-2	A1-A2 1-2	A1-A2 1-2	A1-A2 1-2	A1-A2 1-2	A1-A2 1-2	A1-A2 1-2	A1-A2 1-2
NO	NO	NC	NC	NC	NC	NC	NC	NO	NC
NC	NC	NC	NC	NC	NC	NC	NC	NC	NC
NO	NO	NC	NO	NO	NC	NC	NO	NC	NO
NO	NO	NC	NO	NO	NO	NC	NO	NC	NO

Contact block 61A 1NO+3NC	Contact block 61B 2NO+2NC	Contact block 61C 3NO+1NC	Contact block 61D 3NO+1NC	Contact block 61E 3NO+1NC	Contact block 61G 3NO+1NC	Contact block 61H 2NO+2NC	Contact block 61M 3NO+1NC	Contact block 61R 1NO+3NC	Contact block 61S 3NO+1NC
M12 connector, 12-pole	M12 connector, 12-pole	M12 connector, 12-pole	M12 connector, 12-pole	M12 connector, 12-pole	M12 connector, 12-pole	M12 connector, 12-pole	M12 connector, 12-pole	M12 connector, 12-pole	M12 connector, 12-pole
Contacts Pin no.	Contacts Pin no.	Contacts Pin no.	Contacts Pin no.	Contacts Pin no.	Contacts Pin no.	Contacts Pin no.	Contacts Pin no.	Contacts Pin no.	Contacts Pin no.
A1-A2 1-2	A1-A2 1-2	A1-A2 1-2	A1-A2 1-2	A1-A2 1-2	A1-A2 1-2	A1-A2 1-2	A1-A2 1-2	A1-A2 1-2	A1-A2 1-2
NC	NC	NO	NO	NO	NO	NC	NO	NC	NO
NC	NC	NC	NC	NC	NC	NC	NC	NC	NC
NC	NO	NO	NO	NO	NO	NO	NO	NC	NO
NO	NO	NO	NO	NO	NO	NO	NO	NO	NO

Note: the wires connected to pins 11 and 12 of the M12 connector can be used to activate the LEDs in FG series configurations with freely connectable LEDs.

## 1- Introduction

The purpose of this section is to provide the machine manufacturer with a quick overview of a number of standards related to machine safety, to clarify some basic terms and to provide some application examples. This brief guide only covers aspects related to the functional safety of the machine, i.e., all measures that must be taken to protect the operating personnel from the hazards arising from the operation of the machine, as well as the project planning and selection of the appropriate interlocking devices for the given guard.

The machine designer himself must identify risks that are posed by other hazards, such as live parts, pressurised containers, explosive atmospheres, etc. These risks are not dealt with in this guideline.

Pizzato Elettrica prepared this document to the best of its knowledge, taking into consideration the standards, interpretations and existing technologies. The examples provided here must always be considered by the end customer with respect to the latest state of technology and standardisation. Pizzato Elettrica accepts no responsibility for the examples provided here and does not exclude the possibility of unintentional errors or inaccuracies.

## 2 -Design in safety. Structure of the European standards.

To freely market any type of device or machine in the countries of the European Community, they must comply with the provisions of the EU directives. They establish the general principles for ensuring that manufacturers place products on the market that are not hazardous to the operating personnel. The vast range of products pose many different hazards and, over time, has led to the release of various directives. As an example, consider the Low Voltage Directive 2014/35/EU, the Equipment for Explosive Atmospheres (ATEX) Directive 2014/34/EU, the Electromagnetic Compatibility Directive 2014/30/EU, etc. The hazards that arise from the operation of machinery are described in the Machinery Directive 2006/42/EC.

Conformity with the directives is certified by the Declaration of Conformity issued by the manufacturer and by the application of the CE marking on the machine.

For the assessment of risks posed by a machine and for the realisation of the safety systems for protecting the operating personnel from those risks, the European standardisation organisations CEN and CENELEC have issued a series of standards which translate the contents of the directives into technical requirements. The standards published in the Official Journal of the European Union are harmonised. The manufacturer is to verify conformity with the applied and listed standards.

The machine safety standards are divided into three types: A, B and C.

Type A standards: Standards that cover basic concepts and general principles for design in order to achieve safety in the design of machinery.

Type B standards: Standards that deal with one or more safety aspects and are divided into the following standards:

- B1: Standards on particular safety aspects (e.g. safety distances, temperature, noise, etc.)
- B2: Standards on safeguards (e.g. two-hand controls, interlocking devices, guards, etc.)

Type C standards: Standards that deal with detailed safety requirements for a particular group of machines (e.g. hydraulic presses, injection moulding machines, etc.)

The system or machine manufacturer must therefore determine whether the product is covered by a type C standard. If this is the case, this standard specifies the safety requirements; otherwise, the type B standards shall apply for any specific aspect or device of the product. In the absence of specifications, the manufacturer shall follow the general guidelines stated in the type A standards.

### TYPE A STANDARDS

For example:

EN ISO 12100. Safety of machinery - General principles for design - Risk assessment and risk reduction.

### TYPE B1 STANDARDS

For example:

EN 62061. Safety of machinery - Functional safety of safety-related electrical, electronic and programmable electronic control systems  
EN ISO 13849-1 e -2. Safety-related parts of control systems

### TYPE B2 STANDARDS

For example:

EN 574. Two-hand control devices  
EN ISO 13850. Emergency stop  
EN ISO 14119. Interlocking devices associated with guards  
EN 60204-1. Electrical equipment of machines  
EN 60947-5-1. Electromechanical control circuit devices

### TYPE C STANDARDS

For example:

EN 201. Plastics and rubber machines - Injection moulding machines  
EN 415-1. Safety of packaging machines  
EN 692. Mechanical presses  
EN 693. Hydraulic presses  
EN 848-1. Safety of wood-working machines – One side moulding machines with rotating tool – Part 1: Single spindle vertical moulding machines

## 3 - Designing safe machines. Risk analysis.

The first step in producing a safe machine is to identify the possible hazards to which the operators of a machine are exposed. The identification and classification of the hazards allows the risk for the operator or the combination of the probability of a hazard and the possible injury to be determined.

The methodology for risk analysis and evaluation and the procedure for the elimination/reduction of risks is defined by standard EN ISO 12100. This standard introduces a cyclic analysis model: starting with the initial objectives, the risk analysis and the various possibilities for reducing these risks are repeatedly evaluated until the initial objective is met.

The model introduced in this standard specifies that one proceed as follows after performing a risk analysis to reduce or eliminate risks:

- 1) Elimination of risks at their source through the use of intrinsically safe design principles and the structural set-up of the systems;
- 2) Risk reduction through safeguarding and monitoring systems;
- 3) Identification of residual risks through signalling and by informing the operating personnel.

Since every machine has hazards and because it is not possible to eliminate all possible risks, the objective is to reduce the residual risks to an acceptable level.

If a risk is reduced by means of a monitoring system, standard EN ISO 13849-1, which provides an evaluation model for the quality of this system, comes into play. If a given level is specified for a risk, it is possible to use a safety function of equal or higher level.

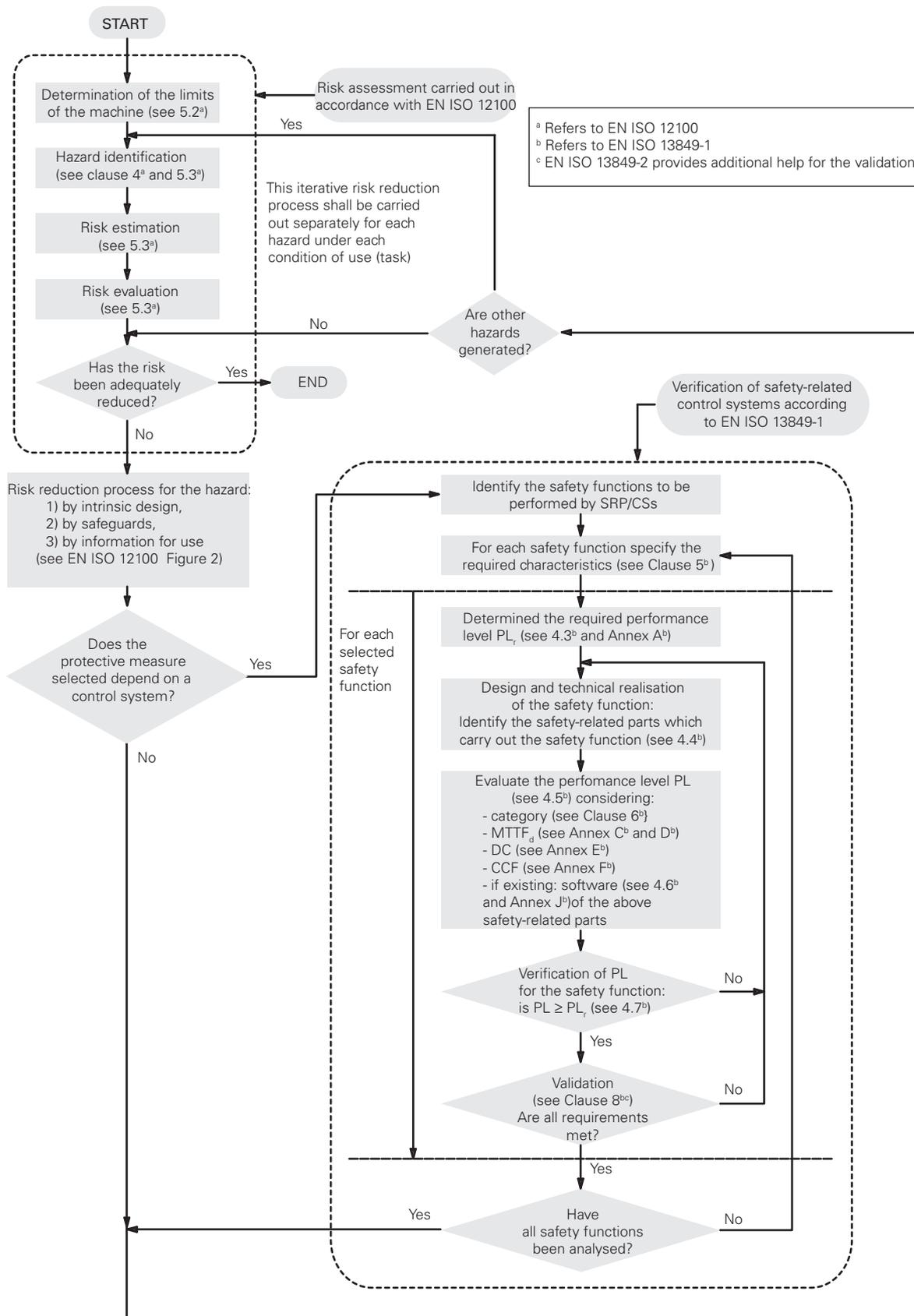

<sup>a</sup> Refers to EN ISO 12100  
<sup>b</sup> Refers to EN ISO 13849-1  
<sup>c</sup> EN ISO 13849-2 provides additional help for the validation

Note: This diagram was created by combining figures 1 and 3 of standard EN 13849-1. The texts in the diagram are not identical to those in the standard.

#### 4 - Positive opening, redundancy, diversification and self-monitoring

##### Positive mode and negative mode.

According to the standard EN ISO 12100, if a moving mechanical component inevitably moves another component along with it, either by direct contact or via rigid elements, these components are said to be connected in the **positive** mode. Instead, if the movement of a mechanical component simply allows another element to move freely, without using direct force (for example by gravity force, spring effect, etc.), that connection is said to be connected in the **negative** mode.

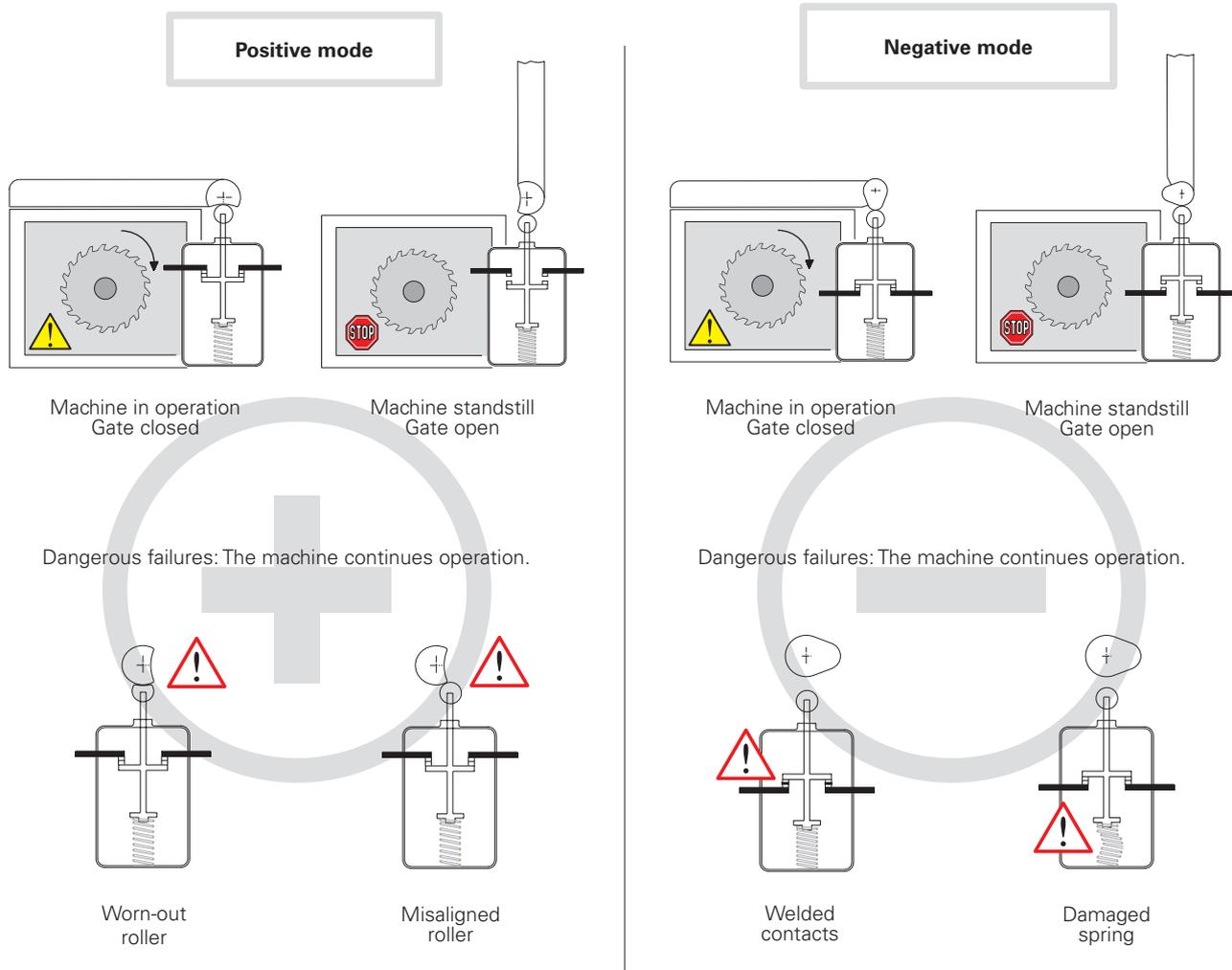

With positive mode, preventive maintenance can be performed, thereby avoiding the dangerous failures described above. With negative mode, on the other hand, failures can occur within the switch and are therefore difficult to detect.

**In the event of an internal failure (welded contacts or a damaged spring), the contacts will still open in positive mode in spite of the damage and the machine will be stopped.**



### Use of switches in safety applications

If only one switch is used in a safety application, the switch must be actuated in positive mode. In order to be used for safety applications, the opening contact (normally closed) must be with “**positive opening**”. All switches with the symbol  are provided with NC contacts with positive opening.

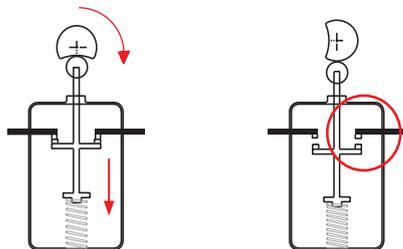

No flexible connection between the moving contacts and the actuator on which the actuating force is exerted.

In case of two or more switches, they should operate in opposite modes, for example:

- The first with an NC contact (normally closed contact), actuated by the guard in positive mode.
- The other with an NO contact (normally open contact), actuated by the guard in negative mode.

This is a common practice, though it does not exclude the possible use of two switches that are actuated in positive mode (see diversification).

### Diversification

In redundant systems, safety is increased through **diversification**. This can be obtained by using two switches with different design and/or technology; failures with the same cause can thereby be prevented. Examples for diversification include: the use of one switch with positive actuation and one switch without positive actuation, the use of one switch with mechanical actuation and one switch without mechanical actuation (e.g., electronic sensor) or the use of two switches with mechanical, positive actuation but with different types of actuation (e.g., an FR 693-M2 key switch and a switch with FR 1896-M2 hinge pin).

### Redundancy

**Redundancy** implies the use of more than one device or system to make sure that, in case of a failure in one device, there is another one available to perform the required safety functions. If the first failure is not detected, an additional failure may lead to the loss of the safety function.

### Self-monitoring

**Self-monitoring** consists in an automatic control performed to check the functioning of all devices involved in the machine working-cycle. This way the next working cycle can be either accepted or rejected.

### Redundancy and self-monitoring

Combining **redundancy** and **self-monitoring** in the same system makes sure that a first failure in the safety circuit does not lead to the loss of safety functions. This first failure will be detected at the next re-start or, in any case, before a second failure which may lead to the loss of the safety function.

## 5 - Design and selection of interlocking devices associated with guards (standard EN ISO 14119)

The European standard EN ISO 14119 "Interlocking devices associated with guards – Principles for design and selection" came into force on October 2, 2013, and superseded EN 1088/ISO 14119:1998 as of May 2015.

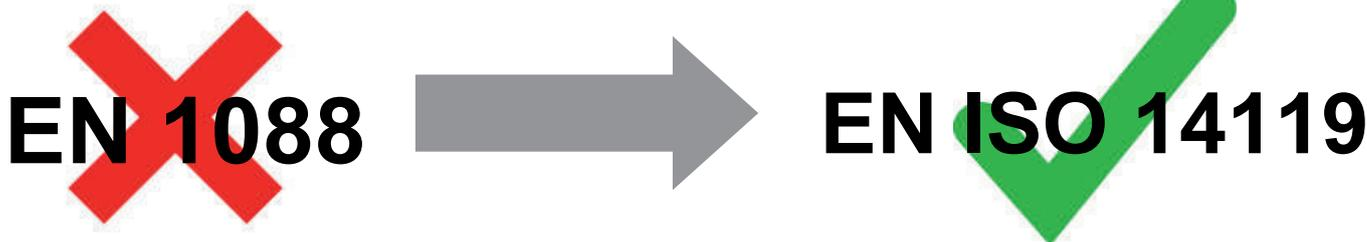

The standard is intended for manufacturers of interlocking devices as well as machine manufacturers (and integrators) and describes the requirements on the devices and their correct installation.

The new standard provides clarification to a number of questions that are not always clear cut and considers the latest technologies used in the design of interlocking devices, defines a number of parameters (actuator type and level of coding) and describes the procedure for correct installation with the goal of minimizing the defeat possibilities of the interlocking devices.

The standard also considers other aspects related to interlocking devices (e.g. guard locking principles, electromagnetic guard locking, auxiliary release, escape and emergency release, etc.) which are not described here.

### Coding level of the actuators

An important new addition to the standard is the definition of a coded actuator and the classification of the coding levels:

- **coded actuator** – actuator which was specially designed for use with a specific interlocking device;
- **low level coded actuator** – coded actuator for which 1 to 9 variations in code are available (e.g. the SR magnetic switch series or the safety switches with separate actuator and mechanical detection FS, FG, FR, FD...);
- **medium level coded actuator** – coded actuator for which 10 to 1000 variations in code are available;
- **high level coded actuator** – coded actuator for which more than 1000 variations are available. (e.g. the ST series sensors with RFID technology or the interlocking devices of the NG and NS series with RFID technology and guard locking).

### Types of interlocking devices

Standard EN ISO 14119 defines different types of interlocking devices:

- **Type 1 interlocking device** – interlocking device that is mechanically actuated by an uncoded actuator (e.g. HP series hinged interlocking devices)
- **Type 2 interlocking device** – interlocking device that is mechanically actuated by a coded actuator (e.g. safety switches with separate actuator of the FR, FS, FG, ... series)
- **Type 3 interlocking device** – interlocking device that is contactlessly actuated by an uncoded actuator
- **Type 4 interlocking device** – interlocking device that is contactlessly actuated by a coded actuator (e.g. ST series safety sensors with RFID technology and NG and NS series safety switches with RFID technology)

Examples of actuation principles		Actuator examples		Type
Mechanical	Direct contact/force	Uncoded	Rotary cam Linear cam Hinge	Type 1
		Coded	Key-actuated Trapped key	Type 2
Non-contact	Inductive	Uncoded	Ferromagnetic material	Type 3
	Magnetic		Magnet, solenoid	
	Capacitive		Any suitable object	
	Ultrasonic	Any suitable object		
Optic	Magnetic	Coded magnet	Type 4	
RFID	Coded RFID tag			
Optic	Optically coded tag			

Excerpt from EN ISO 14119 - Table 1

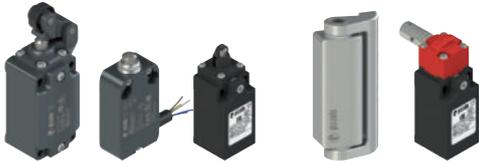

## Requirements for the design and the installation of interlocking devices according to EN ISO 14119 to reduce defeating of guards.

	Type 1 devices		Type 2 and type 4 devices	Type 2 and type 4 devices
	Cam safety switches rotary or linear cam	Safety hinge switches	Low and medium level coded actuators	High level coded actuators
Principles and measures against defeating				
Installation out of reach (1)				
Barriers or shielding (2)				
Installation in hidden position (3)	X		X	
Testing by means of control circuit (4)				
Non-detachable fixing of position switch and cam				
Non-detachable fixing of position switch		M		
Non-detachable fixing of the actuation element or cam		M	M	M
Additional position sensing and plausibility check	R		R	

Excerpt from EN ISO 14119 - Table 3

X: mandatory to apply at least one of the measures listed in the "Principles and measures" column

M: mandatory measure

R: recommended measure

It is clear that the use of devices with RFID technology, high coding level and hinged switches is the easiest way to meet the requirements of EN ISO 14119, as it is only necessary to fulfil a few requirements in order to prevent defeating of guards. Devices with low or medium coding level require additional measures to ensure a tamperproof application.

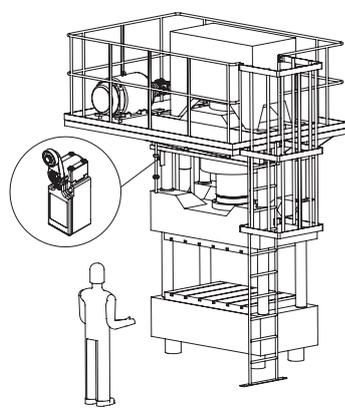

(1) - Installation out of reach

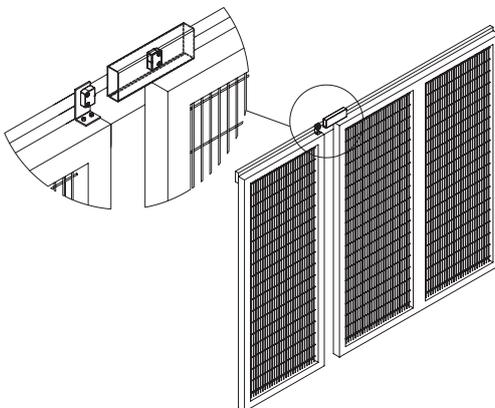

(2) - Barriers or shielding

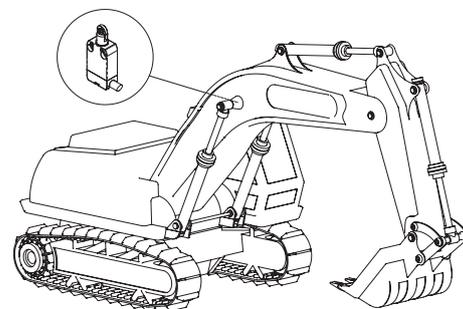

(3) - Installation in hidden position

(4) - Status monitoring or periodic testing can, for example, be performed on a machine with a simple operating cycle so as to verify that the guards are actually open at the end of or during specific operating phases (e.g. to remove the processed material or to perform quality controls). If status monitoring does not detect opening of the guard, an alarm is generated and the machine is stopped.

### Guard locking devices and holding force

The manufacturer of the interlocking device with guard locking must ensure that the device can withstand at least the measured holding force  $F_{zh}$  while the interlock is engaged. This holding force must not exceed the maximum holding force divided by a safety coefficient equal to 1.3.

$$F_{zh} = \frac{F_{1max}}{1,3}$$

Example: A device with maximum holding force of  $F_{zh} = 2000$  N must pass a test with a maximum holding force equal to  $F_{1max} = 2600$  N.

An interlocking device with guard locking can both monitor the position of the guard (open/closed) as well as lock the guard (locked/unlocked). Each of the two functions may require a different PL safety level (acc. to EN ISO 13849-1). The guard locking function generally requires a lower PL than the position monitoring function. (See paragraph 8.4, note 2 of EN ISO 14119).

To identify whether an interlocking device also performs status monitoring, the standard specifies that the product label includes the symbol shown to the side here.



## 6 - Current status of the standards. Reason for changes, new standards and some overlapping

The “traditional” standards for functional safety, such as EN 954-1, played a large part in formalising some of the basic principles for the analysis of safety circuits on the basis of deterministic principles. On the other hand, they make no mention of the topic of programmable electronic control systems and are not generally in line with the current state of technology. To take programmable electronic control systems into account in the analysis of safety circuits, the approach taken by current standards is fundamentally probabilistic and introduces new statistical variables.

This approach is based on IEC 61508, which deals with the safety of complex programmable electronic systems and is very extensive (divided into 8 sections with nearly 500 pages). It is also used in a diverse range of application fields (chemical industry, machine construction, nuclear plants). This standard introduces the SIL concept (Safety Integrity Level), a probabilistic indication of a system’s residual risk.

From IEC 61508 comes EN 62061, which covers the functional safety of the complex electronic or programmable control systems in industrial applications. The concepts introduced here permit general use for any safety-related electrical, electronic and programmable electronic control systems (systems with non-electrical technologies are not covered).

EN ISO 13849-1, developed by CEN under the aegis of ISO, is also based on this probabilistic approach. This standard, however, attempts to structure the transition to the concepts in a less problematic way for the manufacturer, who is accustomed to the concepts of EN 954-1. The standard covers electromechanical, hydraulic, “non-complex” electronic systems and some programmable electronic systems with predefined structures. EN ISO 13849-1 is a type B1 standard and introduces the PL concept (Performance Level); as with SIL, the concept provides a probabilistic indication of a machine’s residual risk. This standard points out a correlation between SIL and PL; concepts borrowed by EN 61508 – such as DC and CCF – are used and a connection to the safety categories of EN 954-1 is established.

In the area of functional safety for the safety of control circuits, there are thus two standards presently in force:

EN ISO 13849-1. Standard type B1, which uses the PL concept.

EN 62061. Standard type B1, which uses the SIL concept.

### Important note

EN 13849-1 is a type B1 standard; if a type C standard is already applied for a machine, the type C standard is to be used. Some type C standards not yet updated are based on the concepts of EN 954-1. For manufacturers of machines that are covered by a type C standard, the introduction time of the new standards depends on how quickly the various technical committees update the C standards.

There is clear overlapping of the two standards EN 62061 and EN ISO 13849-1 concerning their application field and many aspects are similar; there is also a link between the two symbol names (SIL and PL), which indicate the result of the analyses according to the two standards.

PL EN ISO 13849-1	a	b	c	d	e
SIL EN 62061 - IEC 61508	-	1	1	2	3
PFH <sub>D</sub>	from 10 <sup>-4</sup> to 10 <sup>-5</sup>	from 10 <sup>-5</sup> to 3x10 <sup>-6</sup>	from 3x10 <sup>-6</sup> to 10 <sup>-6</sup>	from 10 <sup>-6</sup> to 10 <sup>-7</sup>	from 10 <sup>-7</sup> to 10 <sup>-8</sup>
A hazardous failure every n years	from ~1 to ~10	from ~10 to ~40	from ~40 to ~100	from ~100 to ~1000	from ~1000 to ~10000

The choice of the standard to be applied is left to the manufacturer according to the technology that is used. We believe that standard EN ISO 13849-1 is easier to use thanks to its mediatory approach and the re-utilisation of the concepts already introduced on the market.

**7 - Standard EN ISO 13849-1 and the new parameters: PL, MTTF<sub>D</sub>, DC, CCF**

Standard EN ISO 13849-1 offers the manufacturer an iterative method for assessing whether the hazards posed by a machine can be reduced to an acceptable residual level through the use of appropriate safety functions. The applied method specifies a hypothesis-analysis-validation cycle for each risk. Once completed, it must be possible to demonstrate that every selected safety function is appropriate for the respective risk.

The first step involves the determination of the required performance level, which is required of each safety function. Like EN 954-1, EN ISO 13849-1 also uses a risk graph for the risk analysis of a machine function (figure A.1). Instead of a safety category, however, this graph is used to determine – as a function of the risk – a Required Performance Level or PL<sub>r</sub> for the safety function which protects the respective part of the machine.

Starting with point 1 of the graph, the machine manufacturer answers questions S, F and P and can then determine the PL<sub>r</sub> for the safety function being examined. He must then develop a system with a performance level PL that is equal to or greater than that which is required to protect the operating personnel.

**Risk graph for determining the required PL<sub>r</sub> for the safety function (excerpt from EN ISO 13849-1, figure A.1)**

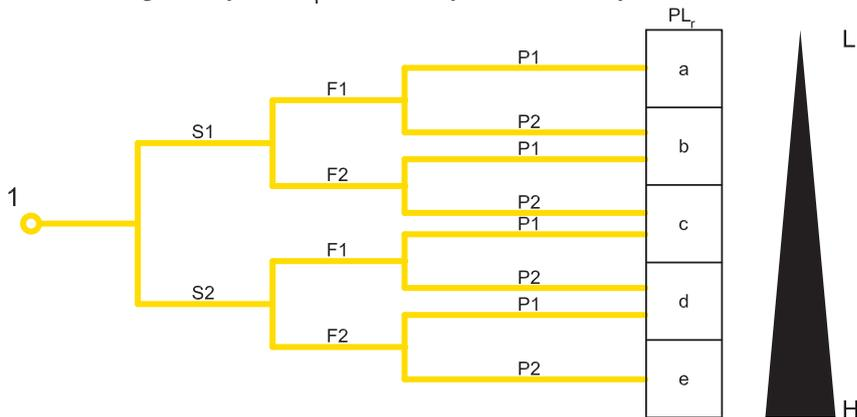

Key

- 1 Starting point for the evaluation of the safety function's contribution to risk reduction
- L Low contribution to risk reduction
- H High contribution to risk reduction
- PL<sub>r</sub> Required performance level

Risk parameters

- S** Severity of injury
  - S1** Slight (normally reversible injury)
  - S2** Serious (normally irreversible injury or death)
- F** Frequency and/or exposure to hazard
  - \*F1** Seldom-to-less-often and/or exposure time is short
  - \*\*F2** Frequent-to-continuous and/or exposure time is long
- P** Possibility of avoiding hazard or limiting harm
  - P1** Possible under certain conditions
  - P2** Scarcely possible

\* F1 should be selected if the total duration of the exposure to the hazard does not exceed 1/20 of the total work time and the frequency of exposure to the hazard does not exceed once every 15 minutes  
 \*\* If there are no other reasons, F2 should be selected if the frequency of exposure to the hazard is greater than once every 15 minutes.

Category required by EN 954-1	Required performance level (PL <sub>r</sub> ) and category acc. to EN ISO 13849-1
B	→ b
1	→ c
2	→ d, Category 2
3	→ d, Category 3
4	→ e, Category 4

Note: For a machine manufacturer, it may be of interest forego repeating the risk analysis of the machine and to instead to try and reuse the data already derived from the EN 954-1 risk analysis. This is not generally possible, since the risk graph changed with the new standard (see previous figure) and, as a result, the required performance level of the safety function may have changed with identical risks. The German Institute for Occupational Safety and Health (BGIA), in its report 2008/2 on EN ISO 13849-1, recommends the following: assuming the "worst case," implementation can occur according to the table to the right. For further information, refer to the mentioned report.

There are five performance levels, from PL a to PL e, with increasing risk; each represents a numerical range for the average probability of a dangerous failure per hour. For example, PL d specifies that the average probability of dangerous failures per hour is between 1x10<sup>-6</sup> and 1x10<sup>-7</sup>, i.e., about 1 dangerous failure every 100-1000 years.

PL	Average probability of dangerous failures per hour PFHd (1/h)	
a	≥ 10 <sup>-5</sup>	e < 10 <sup>-4</sup>
b	≥ 3 x 10 <sup>-6</sup>	e < 10 <sup>-5</sup>
c	≥ 10 <sup>-6</sup>	e < 3 x 10 <sup>-6</sup>
d	≥ 10 <sup>-7</sup>	e < 10 <sup>-6</sup>
e	≥ 10 <sup>-8</sup>	e < 10 <sup>-7</sup>

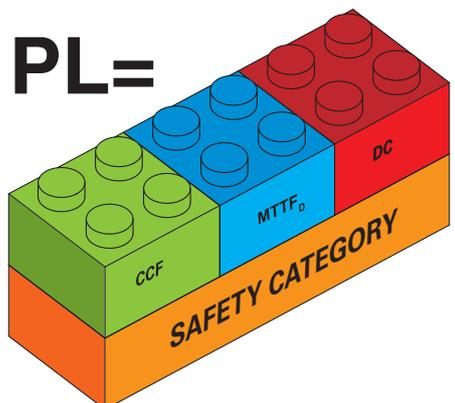

- Several parameters are needed to determine the PL of a control system:
1. The safety category of the system, which is dependent on the architecture (structure) of the control system and its behaviour in the event of damage
  2. MTTF<sub>D</sub> of the components
  3. DC or Diagnostic Coverage of the system.
  4. CCF or Common Cause Failures.

**Safety category.**

Most control circuits normally used can be represented with the following logic components:

- Input or signal input
- Logic or signal processing logic
- Output or output of the monitoring signal

These are connected to one another differently depending on the structure of the control circuit.

EN ISO 13849-1 allows for five different basic circuit structures, referred to as the designated architectures of the system. As shown in the following table, the architectures – combined with the requirements on the system behaviour in the event of failure and the minimum values of  $MTTF_D$ , DC and CCF – give the safety category of the system control. Thus, the safety categories of EN ISO 13849-1 are not the equivalent, but rather extend the concept of the safety category introduced by the previous standard EN 954-1.

Cat-egory	Summary of the requirements	System behaviour	Safety principles	$MTTF_D$ of each channel	$DC_{avg}$	CCF
<b>B</b>	Safety-related parts of monitoring systems and/or their protective equipment, as well as their accessories, must be designed, constructed, selected, assembled and combined in accordance with the relevant standards so that they can withstand the expected influences. Fundamental safety principles must be used.  Architecture:	The occurrence of a fault can lead to the loss of the safety function.	Mainly determined by the selection of components	Low to medium	None	Not relevant
<b>1</b>	In addition to the requirements of Category B, proven components and safety principles must be used.  Architecture:	The occurrence of a fault can lead to the loss of the safety function; the probability of fault occurrence is, however, lower than for Category B.	Mainly determined by the selection of components	High	None	Not relevant
<b>2</b>	Requirements of Category B and proven safety principles must be used. The safety function must be checked at appropriate intervals by the control system.  Architecture:	The occurrence of a fault between two checks can lead to the loss of the safety function. The loss of the safety function is detected through the check.	Determined mainly by the structure	Low to high	Low to medium	See Annex F
<b>3</b>	Requirements of Category B and proven safety principles must be used. Important safety-related parts must be designed so that: - A single fault in any of these parts does not lead to the loss of the safety function. - Where reasonably practicable, the single fault is detected.  Architecture:	If a single fault occurs, the safety function is always performed. Some, but not all faults are detected. Accumulation of undetected faults can lead to the loss of the safety function.	Determined mainly by the structure	Low to high	Low to medium	See Annex F
<b>4</b>	Requirements of Category B and proven safety principles must be used. Important safety-related parts must be designed, so that: - a single fault in any of these parts does not lead to the loss of the safety function, and - a single fault during or before the next request for the safety function is detected. If this is not possible, the accumulation of undetected faults must not lead to the loss of the safety function.  Architecture:	If a single fault occurs, the safety function is always performed. The detection of accumulated faults reduces the probability of the loss of the safety function (high DC). The faults are detected in time to prevent the loss of the safety function.	Determined mainly by the structure	High	High (including accumulation of faults)	See Annex F

### MTTF<sub>D</sub> ("Mean Time To Dangerous Failure").

This parameter is used to determine the functional system quality over the mean lifetime in years before a dangerous failure occurs (other failures are not considered). The calculation of the MTTF<sub>D</sub> is based on numerical values supplied by the manufacturers of the individual components of the system. In the absence of this data, the values can be taken from the tables with guide values included in the standard (EN ISO 13849-1 Annex C). The evaluation results in a numerical value, divided into three categories: High, Medium or Low.

Classification	Values
Not acceptable	MTTF <sub>D</sub> < 3 years
Low	3 years ≤ MTTF <sub>D</sub> < 10 years
Medium	10 years ≤ MTTF <sub>D</sub> < 30 years
High	(30 years ≤ MTTF <sub>D</sub> ≤ 100 years)

For components that are susceptible to high wear (typical for mechanical and hydraulic devices), the manufacturer supplies the value B<sub>10D</sub> for the component, i.e., the number of component operations within which 10% of the samples failed dangerously, instead of the MTTF<sub>D</sub> of the component.

The B<sub>10D</sub> value of the component must be converted to MTTF<sub>D</sub> by the machine manufacturer using the following formula:

$$MTTF_D = \frac{B_{10D}}{0,1 \cdot n_{op}}$$

Where n<sub>op</sub> = means number of annual operations for the component.

By assuming the daily operating frequency and the daily operating hours for the machine, n<sub>op</sub> can be calculated as follows:

$$n_{op} = \frac{d_{op} \cdot h_{op} \cdot 3600s/h}{t_{ciclo}}$$

where

d<sub>op</sub> = work days per year

h<sub>op</sub> = operating hours per day

t<sub>cycle</sub> = cycle time (s)

For components that are susceptible to wear, note that parameter MTTF<sub>D</sub> is dependent not only on the component itself but also on the application. An electromechanical device with low frequency of use, e.g. a remote switch that is only used for emergency stops, has a high MTTF<sub>D</sub>; if the same device is used for normal processes in the operating cycle, the MTTF<sub>D</sub> of the same remote switch could drop dramatically.

All elements of the circuit contribute to the calculation of the MTTF<sub>D</sub> depending on their structure. In control systems with single-channel architecture (as is the case in categories B, 1 and 2), the contribution of each components is linear and the MTTF<sub>D</sub> of the channel is calculated as follows:

$$\frac{1}{MTTF_D} = \sum_{i=1}^N \frac{1}{MTTF_{D_i}}$$

To avoid overly optimistic designs, the maximum value of the MTTF<sub>D</sub> of each channel is limited to 100 years (for categories B, 1, 2 and 3) or 2500 years (category 4). Channels with an MTTF<sub>D</sub> of less than 3 years are not allowed.

For two-channel systems (categories 3 and 4), the MTTF<sub>D</sub> of the circuit is calculated by averaging the MTTF<sub>D</sub> of the two channels using the following formula:

$$MTTF_D = \frac{2}{3} \left[ MTTF_{DC1} + MTTF_{DC2} - \frac{1}{\frac{1}{MTTF_{DC1}} + \frac{1}{MTTF_{DC2}}} \right]$$

### DC ("Diagnostic Coverage").

This parameter provides information on the effectiveness of a system's ability to self-detect any possible failures within the system. Using the percentage of the detectable dangerous failures, one obtains a diagnostic coverage of better or worse quality. The numerical DC parameter is a percentage value which is calculated using values taken from a table (EN ISO 13849-1 Annex E). Depending on the measures for failure detection taken by the manufacturer, example values are provided there. Because multiple measures are normally taken to rectify different anomalies in the same circuit, an average value or a DC<sub>avg</sub> is calculated and can be assigned four levels:

High DC<sub>avg</sub> ≥ 99%

Medium 90% ≤ DC<sub>avg</sub> < 99%

Low 60% ≤ DC<sub>avg</sub> < 90%

None DC<sub>avg</sub> < 60%

A diagnostic coverage of none is only permissible for systems of category B or 1.

### CCF ("Common Cause Failures")

For the calculation of the PL for systems of category 2, 3 or 4, it is also necessary to evaluate possible common cause failures or CCF, which may compromise the redundancy of the system. The evaluation is performed using a checklist (Annex F of EN ISO 13849-1); on the basis of the measures taken against common cause failures, points from 0 to 100 are assigned. The minimum permissible value for categories 2, 3 and 4 is 65 points.

**PL ("Performance Level")**

After determining this data, EN ISO 13849-1 gives the PL of the system using an assignment table (EN ISO 13849-1) or, alternatively, using a simplified graphic (EN ISO 13849-1, paragraph 4.5) as shown in the following.

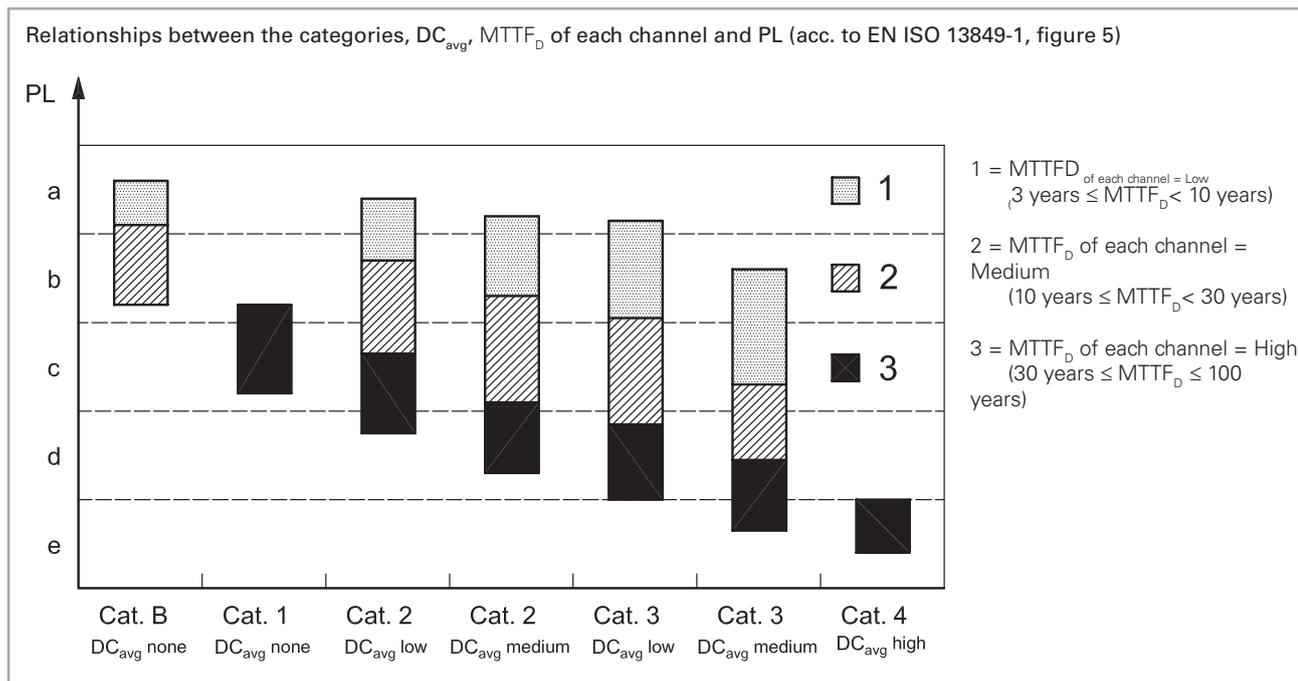

This figure is very useful, as it can be read from multiple points of view. For a given  $PL_r$ , it shows all possible solutions with which this PL can be achieved, i.e., the possible circuit structures that provide the same PL.

Considering the figure more closely, it is seen that the following possibilities exist for a system with PL equal to "c":

1. Category 3 system with less reliable components ( $MTTF_D$ =low) and medium DC.
2. Category 3 system with reliable components ( $MTTF_D$ =medium) and low DC.
3. Category 2 system with reliable components ( $MTTF_D$ =medium) and medium DC.
4. Category 2 system with reliable components ( $MTTF_D$ =medium) and low DC.
5. Category 1 system with very reliable components ( $MTTF_D$ =high).

Considering a given circuit structure, in this figure one can also identify the maximum PL that can be reached depending on the average diagnostic coverage and the  $MTTF_D$  of the components.

Thus, the manufacturer can exclude a number of circuit structures in advance, as they do not meet the required  $PL_r$ .

However, the figure is not usually used to determine the PL of the system since the graphic areas overlap the boundaries of the different PL levels in many cases. Instead, the table in Annex K of standard EN ISO 13849-1 is used to precisely determine the PL of the circuit.

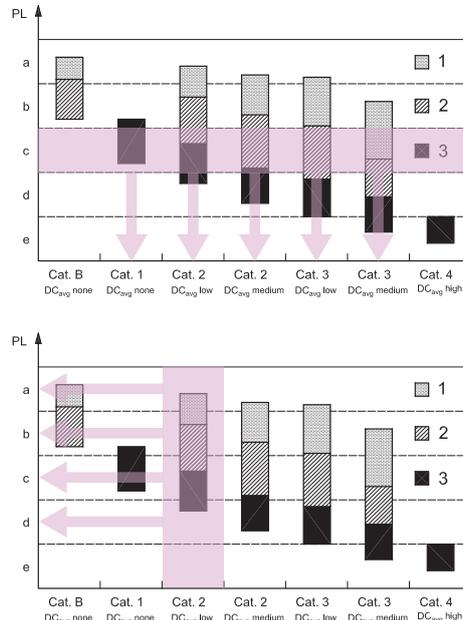



## Table of safety parameters

The  $B_{10D}$  data in the table refers to the mechanical life of the device contacts under normal ambient conditions.

The value of  $B_{10D}$  for NC and NO contacts refers to a maximum electrical load of 10% of the current value specified in the utilisation category. Mission time (for all articles listed below): 20 years.

### Electromechanical control devices

Series	Article description	$B_{10D}$ (NO)	$B_{10D}$ (NC)	$B_{10}/B_{10D}$
F••••	Position switches	1,000,000	40,000,000	50%
F••93 F••92	Safety switches with separate actuator	1,000,000	2,000,000	50%
F••99 F••R2	Safety switches with separate actuator with lock	1,000,000	1,000,000	50%
FG	Safety switches with separate actuator with lock	1,000,000	5,000,000	20%
FS	Safety switches with separate actuator with lock	1,000,000	4,000,000	20%
F••96 F••95	Safety switches with hinge pin	1,000,000	5,000,000	20%
F••C•	Switches with slotted hole lever for hinged guards	1,000,000	2,000,000	50%
F••••	Rope switches for emergency stop	1,000,000	2,000,000	50%
HP - HX B•22-•••	Safety hinges	1,000,000	5,000,000	20%
SR	Magnetic safety sensors (with compatible Pizzato Elettrica safety modules)	20,000,000	20,000,000	50%
SR	Magnetic safety sensors (used at max. load: DC12 24 V 250 mA)	400,000	400,000	100%
PX, PA	Foot switches	1,000,000	20,000,000	50%
MK	Micro position switches	1,000,000	20,000,000	50%
NA, NB, NF	Modular pre-wired position switches	1,000,000	40,000,000	50%
E2 C••••••	Contact blocks	1,000,000	40,000,000	50%

Series	Article description	$B_{10D}$	$B_{10}/B_{10D}$
E2 •PU1••••••, E2 •PL1••••••	Single buttons, maintained	2,000,000	50%
E2 •PU2••••••, E2 •PL2••••••	Single buttons, spring-return	30,000,000	50%
E2 •PD••••••, E2 •PT••••••	Double and triple buttons	2,000,000	50%
E2 •PQ••••••	Quadruple buttons	2,000,000	50%
E2 •PE••••••	Emergency stop buttons	600,000	50%
VN NG-AC2605•	Integrated emergency stop buttons on NG series safety switches	100,000	50%
E2 •SE••••••, E2 •SL••••••	Selector switches with and without illumination	2,000,000	50%
E2 •SC••••••	Key selector switches	600,000	50%
E2 •MA••••••	Joysticks	2,000,000	50%

ATEX series	Article description	$B_{10D}$ (NO)	$B_{10D}$ (NC)	$B_{10}/B_{10D}$
F••••-EX•	Position switches	500,000	20,000,000	50%
F••93-EX• F••92-EX•	Safety switches with separate actuator	500,000	1,000,000	50%
F••99-EX• F••R2-EX•	Safety switches with separate actuator with lock	500,000	500,000	50%
F••96-EX• F••95-EX•	Safety switches with hinge pin	500,000	2,500,000	20%
F••C•-EX•	Switches with slotted hole lever for hinged guards	500,000	1,000,000	50%
F••••-EX•	Rope switches for emergency stop	500,000	1,000,000	50%

### Electronic devices

Code/series	Article description	MTTF <sub>D</sub>	DC	PFH <sub>D</sub>	SIL CL	PL	Cat
HX BEE1-•••	Safety hinges with electronic unit	2413	High	1.24E-09	3	e	4
ST	Safety sensors with RFID technology	4077	High	1.20E-11	3	e	4
NG	RFID safety switches with lock						
	Monitoring function: actuator locked - Mode 1	2968	High	1,15E-09	3	e	4
	Monitoring function: actuator present - Mode 2	3946	High	1,15E-09	3	e	4
	Monitoring function: actuator locked - Mode 3	2957	High	1,48E-09	2	d	2
	Monitoring function: actuator present - Mode 3	3927	High	1,48E-09	2	d	2
	Dual-channel control for locking function of the actuator	4011	High	1,51E-10	3	e	4
Single-channel control for locking function of the actuator	4011	High	1,51E-10	2	d	2	
NS	RFID safety switches with lock						
	Monitoring function: actuator locked - Mode 1	2657	High	1.23E-09	3	e	4
	Monitoring function: actuator present - Mode 2	1840	High	1.22E-09	3	e	4
	Monitoring function: actuator locked - Mode 3	2627	High	1.50E-09	2	d	2
	Monitoring function: actuator present - Mode 3	3987	High	1.49E-09	2	d	2
	Dual-channel control for locking function of the actuator	2254	High	2.04E-10	3	e	4
Single-channel control for locking function of the actuator	2254	High	2.04E-10	2	d	2	

$B_{10D}$ : Number of operations after which 10% of the components have failed dangerously

$B_{10}$ : Number of operations after which 10% of the components have failed

$B_{10}/B_{10D}$ : ratio of total failures to dangerous failures.

MTTF<sub>D</sub>: Mean Time To Dangerous Failure

DC: Diagnostic Coverage

PFH<sub>D</sub>: Probability of Dangerous Failure per hour

SIL CL: Safety Integrity Level Claim Limit. Maximum achievable SIL according to EN 62061

PL: Performance Level. PL acc. to EN ISO 13849-1



Electronic devices							
Code/series	Article description	MTTF <sub>D</sub>	DC	PFH <sub>D</sub>	SIL CL	PL	Cat
CS AM-01	Safety module for standstill monitoring	218	Medium	8.70E-09	2	d	3
CS AR-01, CS AR-02	Safety modules for monitoring guards and emergency stops	227	High	1.18E-10	3	e	4
CS AR-04	Safety module for monitoring guards and emergency stops	152	High	1.84E-10	3	e	4
CS AR-05, CS AR-06	Safety modules for monitoring guards, emergency stops and light barriers	152	High	1.84E-10	3	e	4
CS AR-07	Safety module for monitoring guards and emergency stops	111	High	7.56E-10	3	e	4
CS AR-08	Safety module for monitoring guards, emergency stops and light barriers	1547	High	9.73E-11	3	e	4
CS AR-20, CS AR-21	Safety modules for monitoring guards and emergency stops	225	High	4.18E-10	3	e	3
CS AR-22, CS AR-23	Safety modules for monitoring guards and emergency stops	151	High	5.28E-10	3	e	3
CS AR-24, CS AR-25	Safety modules for monitoring guards and emergency stops	113	High	6.62E-10	3	e	3
CS AR-40, CS AR-41	Safety modules for monitoring guards and emergency stops	225	High	4.18E-10	2	d	2
CS AR-46	Safety module for monitoring guards and emergency stops	435	-	3.32E-08	1	c	1
CS AR-51	Safety module for monitoring safety mats and safety bumpers	212	High	3.65E-09	3	e	4
CS AR-90	Safety module for monitoring floor leveling in lifts	382	High	5.03E-10	3	e	4
CS AR-91	Safety module for monitoring floor leveling in lifts	227	High	1.18E-10	3	e	4
CS AR-93	Safety module for monitoring floor leveling in lifts	227	High	1.34E-10	3	e	4
CS AR-94	Safety module for monitoring floor leveling in lifts	227	High	1.13E-10	3	e	4
CS AR-94•U12	Safety module for monitoring floor leveling in lifts	227	High	1.13E-10	3	e	4
CS AR-95	Safety module for monitoring floor leveling in lifts	213	High	5.42E-09	3	e	4
CS AT-0•, CS AT-1•	Safety modules with timer for monitoring guards and emergency stops	88	High	1.23E-08	3	e	4
CS AT-3•	Safety module with timer for monitoring guards and emergency stops	135	High	1.95E-09	3	e	4
CS DM-01	Safety module for monitoring two-hand controls	142	High	2.99E-08	3	e	4
CS DM-02	Safety module for monitoring two-hand controls	206	High	2.98E-08	3	e	4
CS DM-20	Safety module for monitoring two-hand controls	42	-	1.32E-06	1	c	1
CS FS-1•	Safety timer module	404	High	5.06E-10	3	e	4
CS FS-2•, CS FS-3•	Safety timer modules	205	High	1.10E-08	2	d	3
CS FS-5•	Safety timer module	379	Medium	1.31E-09	2	d	3
CS ME-01	Contact expansion module	91	High	5.26E-10	①	①	①
CS ME-02	Contact expansion module	114	High	4.17E-10	①	①	①
CS ME-03	Contact expansion module	152	High	3.09E-10	①	①	①
CS ME-20	Contact expansion module	114	High	6.14E-10	①	①	①
CS ME-3•	Contact expansion module	110	High	4.07E-09	①	①	①
CS M•201	Multifunction safety modules	135	High	1.44E-09	3	e	4
CS M•202	Multifunction safety modules	614	High	1.32E-09	3	e	4
CS M•203	Multifunction safety modules	103	High	1.61E-09	3	e	4
CS M•204	Multifunction safety modules	134	High	1.52E-09	3	e	4
CS M•205	Multifunction safety modules	373	High	2.19E-09	3	e	4
CS M•206	Multifunction safety modules	3314	High	1.09E-09	3	e	4
CS M•207	Multifunction safety modules	431	High	7.08E-09	3	e	4
CS M•208	Multifunction safety modules	633	High	7.02E-09	3	e	4
CS M•301	Multifunction safety modules	128	High	1.88E-09	3	e	4
CS M•302	Multifunction safety modules	535	High	1.57E-09	3	e	4
CS M•303	Multifunction safety modules	485	High	1.76E-09	3	e	4
CS M•304	Multifunction safety modules	98	High	2.05E-09	3	e	4
CS M•305	Multifunction safety modules	535	High	1.57E-09	3	e	4
CS M•306	Multifunction safety modules	100	High	1.86E-09	3	e	4
CS M•307	Multifunction safety modules	289	High	8.38E-09	3	e	4
CS M•308	Multifunction safety modules	548	High	7.27E-09	3	e	4
CS M•309	Multifunction safety modules	496	High	7.46E-09	3	e	4
CS M•401	Multifunction safety modules	434	High	1.73E-09	3	e	4
CS M•402	Multifunction safety modules	478	High	7.24E-09	3	e	4
CS M•403	Multifunction safety modules	438	High	7.42E-09	3	e	4

B<sub>10D</sub>: Number of operations after which 10% of the components have failed dangerously

B<sub>10</sub>: Number of operations after which 10% of the components have failed

B<sub>10</sub>/B<sub>10D</sub>: ratio of total failures to dangerous failures.

MTTF<sub>D</sub>: Mean Time To Dangerous Failure

DC: Diagnostic Coverage

PFH<sub>D</sub>: Probability of Dangerous Failure per hour

SIL CL: Safety Integrity Level Claim Limit. Maximum achievable SIL according to EN 62061

PL: Performance Level. PL acc. to EN ISO 13849-1

① = Depending on the base module

**EXAMPLE 1**

**Application: Guard monitoring**

Reference standard EN ISO 13849-1

Safety category **1**  
Performance Level **PL c**

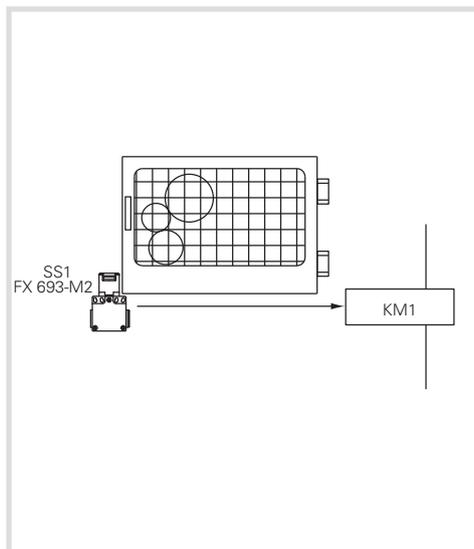
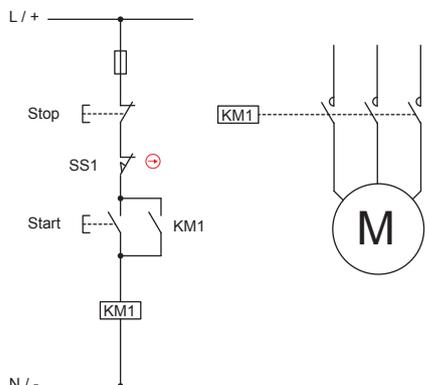

**Description of the safety function**

The control circuit illustrated above has a guard monitoring function. If the guard is open the engine must not be able to start. The hazard analysis showed that the system has no inertia or rather that the engine, once the power has been switched off, stops at a much faster rate than the opening of the guard. The risk analysis has shown that the required PL<sub>r</sub> target is PL c. This is necessary to verify if the intended control circuit with single channel structure is provided with a PL higher or equal to PL<sub>r</sub>.

The guard position is detected by the switch with separate actuator SS1, which operates directly on the contactor KM1. The contactor KM1 monitoring the moving parts is usually activated by the Start and Stop buttons. Though, the analysis of the working cycle has shown that the guard is opening at every switching operation too. Therefore, the number of switch operations by the contactor and by the safety switch can be considered equal.

A circuit structure is defined as single-channel without supervision (category B or 1) if there are only an Input component (switch) and an Output component.

In case a failure on one of the two devices the safety function is not guaranteed anymore.

No measures for fault detection have been applied.

**Device data:**

- SS1 (FX 693-M2) is a switch with positive opening (in accordance with EN 60947-5-1, Annex K). The switch is a well-tried component according to EN ISO 13849-2 table D.4. The B<sub>10D</sub> value of the device supplied by the manufacturer is equal to 2,000,000 switching operations.
- KM1 is a contactor operated at nominal load and is a well-tried component in compliance with EN ISO 13849-2, table D.4. The B<sub>10D</sub> value of this component is equal to 1,300,000 switching operations. This value results from the tables of the applicable standard (see EN ISO 13849-1, table C.1).

**Assumption of the frequency of use**

- It is assumed that the equipment is used for a maximum of 365 days per year, for three shifts of 8 hours and 600 s cycle time. For the switch, the number of switching operations per year is equal to maximum N<sub>op</sub>=(365x24x3,600)/600=52,560.
- It is assumed that the start button is operated every 300 seconds. Therefore, the maximum number of switching operations per year is equal to n<sub>op</sub>/year=105,120
- The contactor KM1 is actuated both for the normal start-stop of the machine as well as for the restart after a guard opening. n<sub>op</sub>/year=52,560+105,120 = 157,680

**MTTF<sub>D</sub> calculation**

The MTTF<sub>D</sub> of the SS1 switch is equal to:  $MTTF_D = B_{10D} / (0,1 \times n_{op}) = 2,000,000 / (0,1 \times 52560) = 381$  years

The MTTF<sub>D</sub> of the KM1 contactor is equal to:  $MTTF_D = B_{10D} / (0,1 \times n_{op}) = 1,300,000 / (0,1 \times 157680) = 82$  years

Therefore, the MTTF<sub>D</sub> of the single-channel circuit is equal to:  $1 / (1/381 + 1/82) = 67$  years

**Diagnostic Coverage DC<sub>avg</sub>**

No measures for fault detection have been applied and there is therefore no diagnostic coverage, a permissible condition for the circuit in question that is in category 1.

**CCF Common Cause Failures**

The CCF calculation is not required for category 1 circuits.

**PL determination**

Using the graph or the figure no. 5 of the standard, it can be verified that for a Category 1 circuit with MTTF<sub>D</sub> = 95 years the resulting PL of the control circuit is PL c. The PL<sub>r</sub> target is therefore achieved.

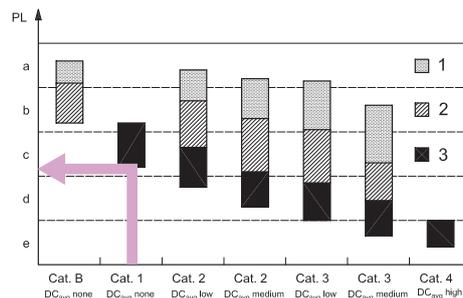

Any information or application example, connection diagrams included, described in this document are to be intended as purely descriptive. The choice and application of the products in conformity with the standards, in order to avoid damage to persons or goods, is the user's responsibility.

**EXAMPLE 2****Application: Emergency stop control**

Reference standard EN ISO 13849-1

Safety category

**3**

Performance Level

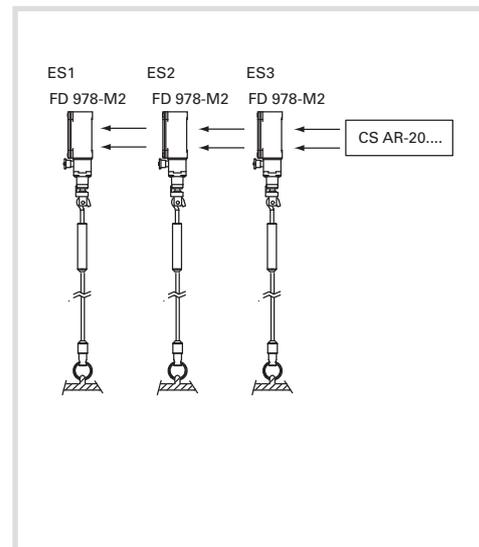
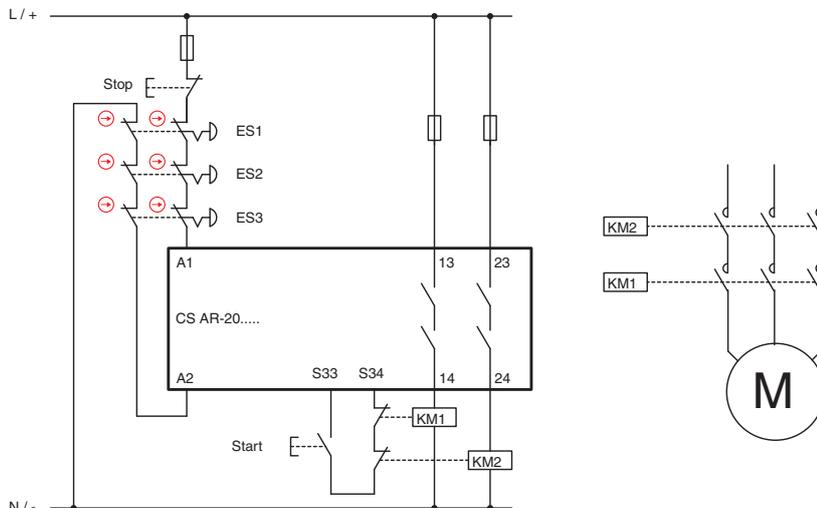
**PL e****Description of the safety function**

The operation of one of the emergency devices causes the intervention of the safety module and the two contactors KM1 and KM2. The signal of the devices ES1, ES2, ES3 is redundantly read by the CS safety module. The contactors KM1 and KM2 (with forcibly guided contacts) are monitored by the CS via the feedback circuit too.

**Device data:**

- The devices ES1, ES2, ES3 (FD 978-M2) are rope switches for emergency stop with positive opening. The B10D value is 2,000,000
- KM1 and KM2 are contactors operated at nominal load. The B10D value is 1,300,000 (see EN ISO 13849-1 - Table C.1)
- CS is a safety module (CS AR-20) with  $MTTF_D = 225$  years and DC = High
- The circuit structure is two-channel in category 3

**Assumption of the frequency of use**

- Twice a month,  $nop/year = 24$
- Start button actuation: 4 times a day
- Assuming 365 working days, the contactors will take action  $4 \times 365 + 24 = 1484$  times / year
- The switches will be operated with the same frequency.
- It is not expected that multiple buttons will be pressed simultaneously.

**MTTF<sub>D</sub> calculation**

- $MTTF_{D, ES1, ES2, ES3} = 833,333$  years
- $MTTF_{D, KM1, KM2} = 8760$  years
- $MTTF_{D, CS} = 225$  years
- $MTTF_{D, ch1} = 219$  years. The value must be limited to 100 years. The channels are symmetric, therefore  $MTTF_D = 100$  years (High)

**Diagnostic Coverage DC<sub>avg</sub>**

- The contacts of KM1 and KM2 are monitored by the CS module via the feedback circuit. DC=99% (High)
- The safety module CS AR-20 is provided with a "High" diagnostic coverage.
- Not all failures in the series of emergency devices can be detected. The diagnostic coverage is 90% (Medium)

**CCF Common Cause Failures**

We assume a score > 65 (acc. to EN ISO 13849-1 - Annex F).

**PL determination**

A circuit in category 3 with  $MTTF_D = \text{High}$  and  $DC_{avg} = \text{High}$  can reach a PL e.

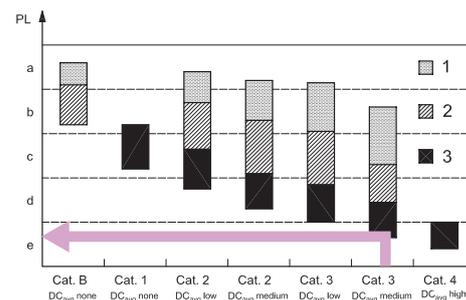

**EXAMPLE 3**

**Application: Guard monitoring**

Reference standard EN ISO 13849-1

Safety category **4**  
Performance Level **PL e**

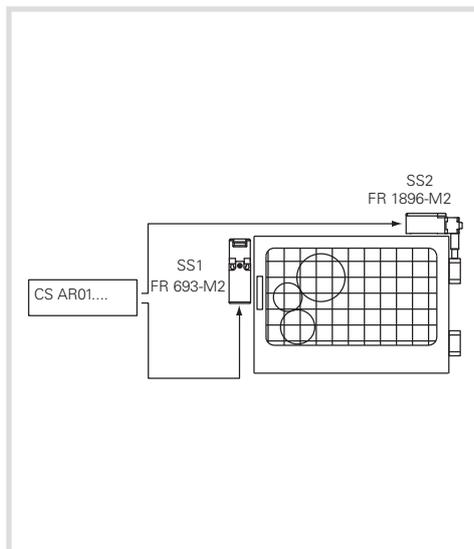
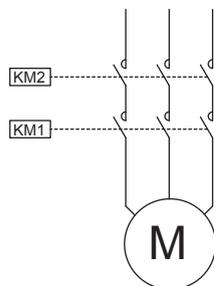
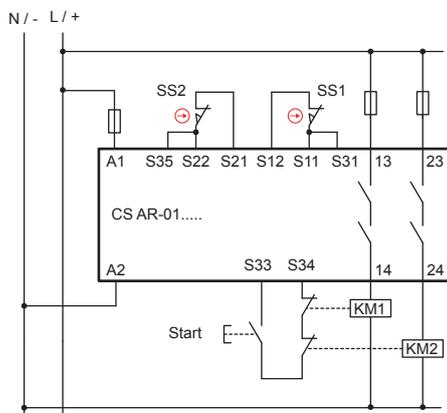

**Description of the safety function**

The guard opening causes the intervention of the switches SS1 and SS2 and, by consequence, of the safety module and the KM1 and KM2 contactors too

The signal of the devices SS1 and SS2 is redundantly monitored by the CS safety module.

The switches have different operating principles.

The contactors KM1 and KM2 (with forcibly guided contacts) are monitored by the CS via the feedback circuit too.

**Device data:**

- The switch SS1 (FR 693-M2) is a switch with positive opening. The  $B_{10D}$  value is 2,000,000
  - The switch SS2 (FR 1896-M2) is a hinge switch with positive opening.  $B_{10D} = 5,000,000$
  - KM1 and KM2 are contactors operated at nominal load.  $B_{10D} = 1,300,000$  (see EN ISO 13849-1 - Table C.1)
  - The CS modules are safety modules (CS AR-01) with  $MTTF_D = 227$  years and DC = High
- Assumption of the frequency of use  
365 days/year, 16 h/day, 1 action every 4 minutes (240 s).  $n_{op}/year = 87,600$ .

**MTTF<sub>D</sub> calculation**

- $MTTF_{D_{SS1}} = 228$  years
- $MTTF_{D_{SS2}} = 571$  years
- $MTTF_{D_{KM1,KM2}} = 148$  years
- $MTTF_{D_{CS}} = 227$  years
- $MTTF_{D_{CH1}} = 64$  years (SS1,CS,KM1)
- $MTTF_{D_{CH2}} = 77$  years (SS2,CS,KM2)
- $MTTF_{D}$ : by calculating the average of the two channels  $MTTF_{D} = 70.7$  years (High) is achieved

**Diagnostic Coverage DC<sub>avg</sub>**

- SS1 and SS2 have DC = 99% since the SS1 and SS2 contacts are monitored by CS and have different operation principles.
- The contacts of KM1 and KM2 are monitored by the CS module via the feedback circuit. DC=99% (High)
- CS AR-01 is provided with an internal redundant and self-monitoring circuit. DC = High
- $DC_{avg} = High$

**PL determination**

A circuit in category 4 with  $MTTF_D = 72.1$  years and  $DC_{avg} = High$  corresponds to PL e.

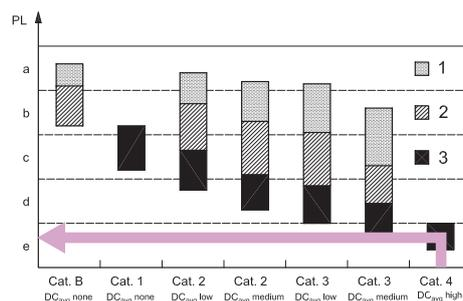

Any information or application example, connection diagrams included, described in this document are to be intended as purely descriptive. The choice and application of the products in conformity with the standards, in order to avoid damage to persons or goods, is the user's responsibility.

**EXAMPLE 4****Application: Guard monitoring**

Reference standard EN ISO 13849-1

Safety category

**4**

Performance Level

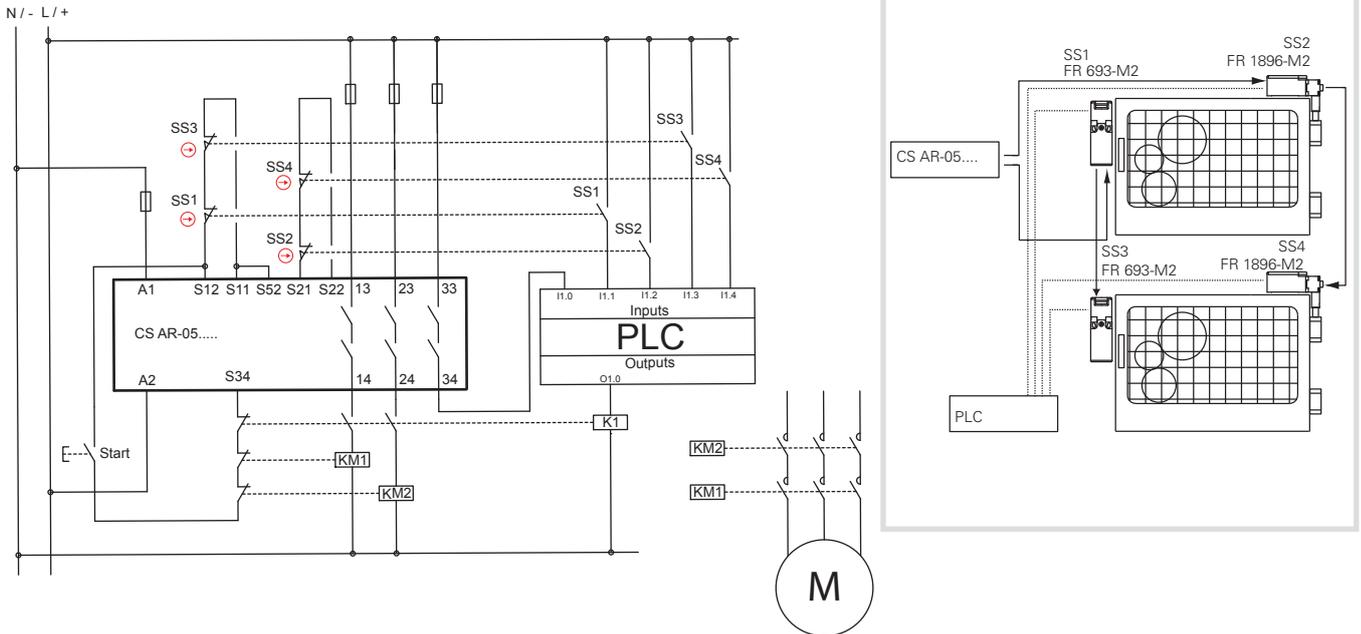
**PL e****Description of the safety function**

The opening of a guard triggers switches SS1 and SS2 on the first guard and triggers SS3, SS4 on the second; the switches trigger the safety module and both contactors KM1 and KM2.

The signal of the devices SS1, SS2 and SS3, SS4 is redundantly monitored by the CS safety module. Furthermore, an auxiliary contact of the switch is monitored by the PLC.

The switches have different operating principles.

The contactors KM1 and KM2 (with forcibly guided contacts) are monitored by the CS via the feedback circuit too.

**Device data:**

- The switches SS1, SS3 (FR 693-M2) are switches with positive opening. The  $B_{10D}$  value is 2,000,000
- The switches SS2, SS4 (FR 1896-M2) are hinge switches with positive opening.  $B_{10D} = 5,000,000$
- KM1 and KM2 are contactors operated at nominal load. The  $B_{10D}$  value is 1,300,000 (see EN ISO 13849-1 - Table C.1)
- CS is a safety module (CS AR-05) with  $MTTF_D = 152$  years and DC = High

**Assumption of the frequency of use**

- 4 times per hour for 24 h/day for 365 days/year equal to  $n_{op}/year = 35,040$
- The contactors will operate for twice the number of operations = 70,080

**MTTF**

- $MTTF_{D, SS1, SS3} = 571$  years;  $MTTF_{D, SS2, SS4} = 1,427$  years
- $MTTF_{D, KM1, KM2} = 185$  years
- $MTTF_{D, CS} = 152$  years
- $MTTF_{D, Ch1} = 73$  years (SS1, CS, KM1) / (SS3, CS, KM1)
- $MTTF_{D, Ch2} = 79$  years (SS2, CS, KM2) / (SS4, CS, KM2)
- $MTTF_D$ : by calculating the average of the two channels  $MTTF_D = 76$  years (High) is achieved

**Diagnostic Coverage DC<sub>avg</sub>**

- The contacts of KM1, KM2 are monitored by the CS module via the feedback circuit. DC=99%
- All auxiliary contacts of the switches are monitored by the PLC. DC=99%
- The CS AR-05 module has a DC= High
- The diagnostic coverage for both channels is 99% (High)

**CCF Common Cause Failures**

- We assume a score > 65 (acc. to EN ISO 13849-1 - Annex F).

**PL determination**

- A circuit in category 4 with  $MTTF_D = 88.6$  years (High) and  $DC_{avg} = High$  corresponds to PL e.

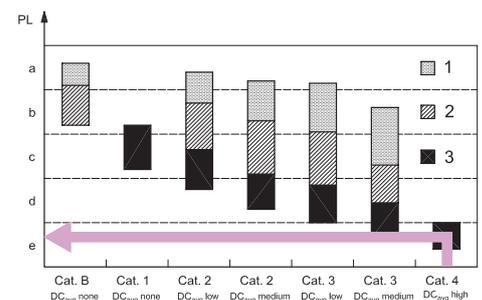

**EXAMPLE 5**

**Application: Guard monitoring**

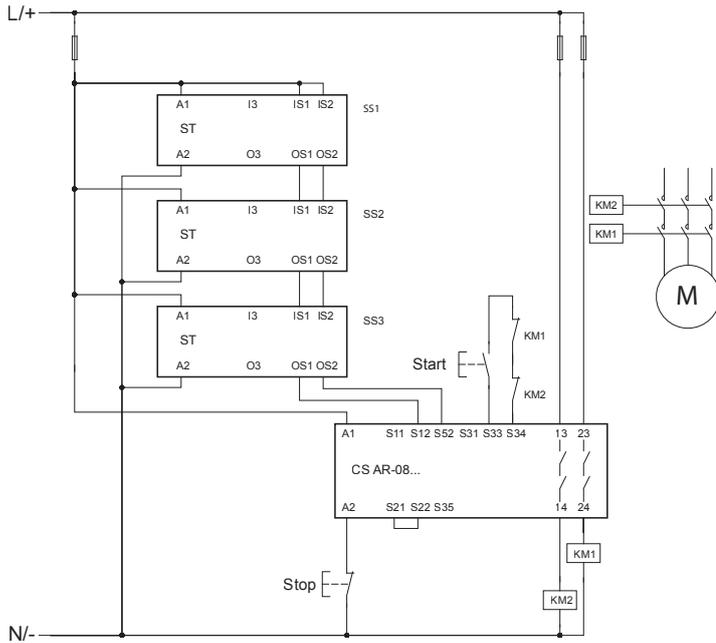

Reference standard EN ISO 13849-1

Safety category	<b>4</b>
Performance Level	<b>PL e</b>

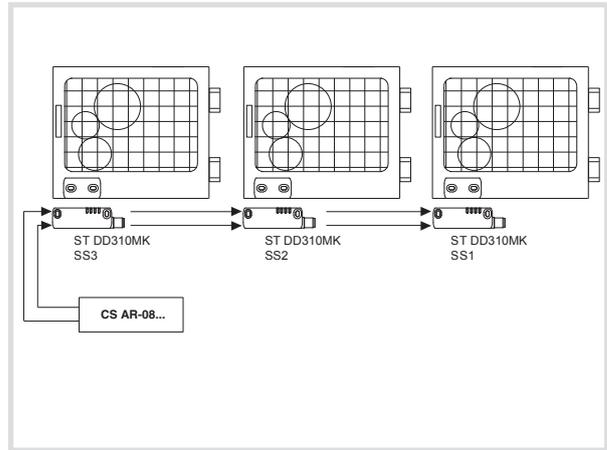

**Description of the safety function**

The opening of guards triggers the sensors SS1 on the first guard, SS2 on the second and SS3 on the third. The sensors trigger the safety module CS AR-08 and the contactors KM1 and KM2 too. The contactors KM1 and KM2 (with forcibly guided contacts) are monitored by the CS AR-08 via the feedback circuit.

**Device data**

SS1, SS2, SS3 are ST series coded sensors with RFID technology.  $PFH_D = 1.20E-11$ , PL = "e"  
 CS AR-08 is a safety module.  $PFH_D = 9.73E-11$ , PL = "e"  
 KM1 and KM2 are contactors operated at nominal load.  $B_{10D} = 1,300,000$  (see EN ISO 13849-1 - Table C.1)

**Assumption of the frequency of use**

Each door is opened every 2 minutes, 16 hours a day, for 365 days a year, equal to  $n_{op} = 175,200$

Definition of the SRP/CS and subsystems

The SRP/CS consists of 5 subsystems (SB):

SB1,2,3 represent the three ST series RFID sensors

SB4 represents the safety module CS AR-08

SB5 represents the two contactors KM1 and KM2 in redundant architecture (cat. 4)



**PFH<sub>D</sub> calculation for SB5**

$MTTF_D$  KM1, KM2 = 74.2 years.

DC = 99%, the contacts of KM1 and KM2 are monitored by the CS safety module via the feedback circuit.

For the CCF parameter we assume a score higher than 65 (acc. to EN ISO 13849-1 - Annex F).

A category 4 circuit with  $MTTF_D = 74.2$  years (high) and high diagnostic coverage (DC = 99%) corresponds to a failure probability of  $PFH_D = 3.4E-08$  and a PL "e".

**Calculation of the total PFH<sub>D</sub> of the SRP/CS**

$$PFH_{D_{TOT}} = PFH_{DSB1} + PFH_{DSB2} + PFH_{DSB3} + PFH_{DSB4} + PFH_{DSB5} = 3.5E-08$$

It corresponds to PL "e".

Calculation example performed with SISTEMA software, downloadable free of charge at [www.pizzato.com](http://www.pizzato.com)

Any information or application example, connection diagrams included, described in this document are to be intended as purely descriptive. The choice and application of the products in conformity with the standards, in order to avoid damage to persons or goods, is the user's responsibility.

**EXAMPLE 6****Application: Guard monitoring**

Reference standard EN ISO 13849-1

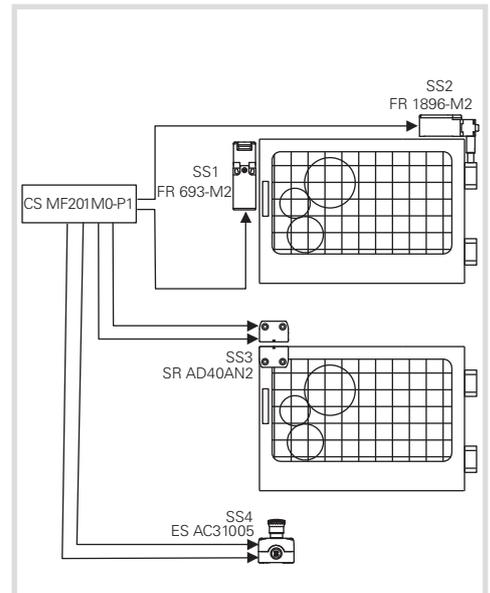
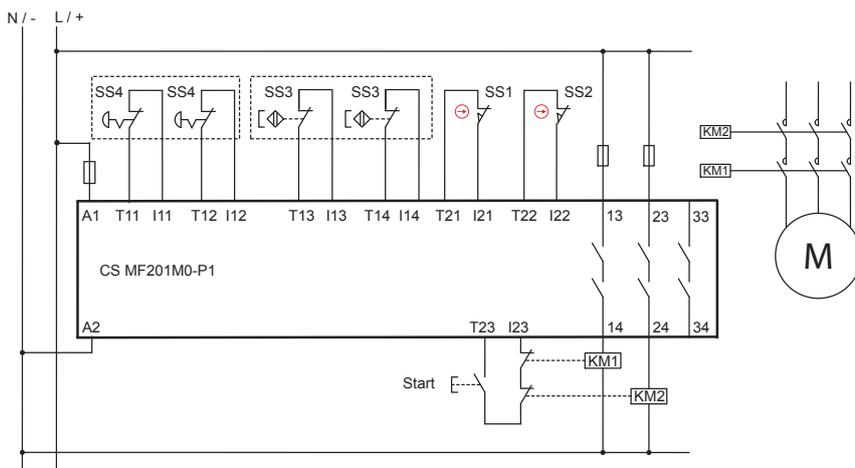
Safety category **4**Performance Level **PL e****Description of the safety function**

The opening of a guard triggers switches SS1 and SS2 on the first guard and triggers sensor SS3 on the second; the switches trigger the safety module and both contactors KM1 and KM2.

The signals from the SS1, SS2 and SS3 devices are redundantly monitored by the CS MF safety module.

There is also an emergency stop button which has a two-channel connection with the safety module too.

The contactors KM1 and KM2 (with forcibly guided contacts) are monitored by the CS MF via the feedback circuit too.

**Device data:**

- The switch SS1 (FR 693-M2) is a switch with positive opening.  $B_{10D} = 2,000,000$
- The switch SS2 (FR 1896-M2) is a hinge switch with positive opening.  $B_{10D} = 5,000,000$
- SS3 (SR AD40AN2) is a magnetic safety sensor.  $B_{10D} = 20,000,000$
- SS4 (ES AC31005) is a housing with emergency stop button (E2 1PERZ4531) provided with 2 NC contacts.  $B_{10D} = 600,000$
- KM1 and KM2 are contactors operated at nominal load.  $B_{10D} = 1,300,000$  (see EN ISO 13849-1 - Table C.1)
- CS MF201M0-P1 is a safety module with  $MTTF_D = 842$  years and  $DC = 99\%$

**Assumption of the frequency of use**

- Each door is opened 2 times per hour for 16 h/day for 365 days/year equal to  $n_{op}/year = 11,680$
- It is assumed that the emergency button is actuated at a maximum of once a day,  $n_{op}/year = 365$
- The contactors will operate for twice the number of operations = 23,725

**MTTF<sub>D</sub> calculation****Guard SS1/SS2**

- $MTTF_{D, SS1, SS2} = 1,712$  years
- $MTTF_{D, SS2, SS4} = 4,281$  years
- $MTTF_{D, KM1, KM2} = 548$  years
- $MTTF_{D, CS} = 842$  years
- $MTTF_{D, CH1} = 278$  years (SS1, CS, KM1)
- $MTTF_{D, CH2} = 308$  years (SS2, CS, KM2)
- $MTTF_D =$  by calculating the average of the two channels  $MTTF_D = 293$  years is achieved

**Guard SS3**

- $MTTF_{D, SS3} = 17,123$  years
- $MTTF_{D, KM1, KM2} = 548$  years
- $MTTF_{D, CS} = 842$  years
- $MTTF_D = 325$  years

**Emergency stop button SS4**

- $MTTF_{D, SS4} = 16,438$  years
- $MTTF_{D, KM1, KM2} = 548$  years
- $MTTF_{D, CS} = 842$  years
- $MTTF_D = 325$  years

**Diagnostic Coverage DC<sub>avg</sub>**

- The contacts of KM1, KM2 are monitored by the CS MF module via the feedback circuit.  $DC=99\%$
- For the devices SS1, SS2 and SS3 it is possible to detect all faults.  $DC=99\%$
- The CS MF201M0-P1 module has a  $DC=99\%$
- We assume a diagnostic coverage of 99% (High)

**CCF Common Cause Failures**

- We assume a score > 65 (acc. to EN ISO 13849-1 - Annex F).

**PL determination**

- A circuit in category 4 with  $MTTF_D \geq 30$  years (High) and  $DC_{avg} =$  High corresponds to PL e.
- The safety functions associated to the guards SS1/SS2, SS3 and the emergency stop button present the level PL e.

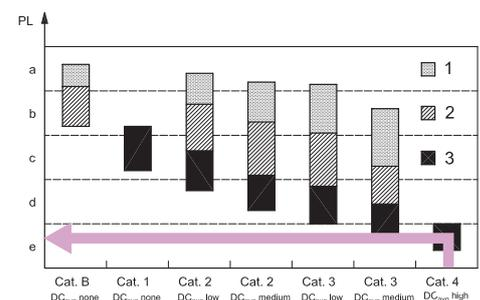

Any information or application example, connection diagrams included, described in this document are to be intended as purely descriptive. The choice and application of the products in conformity with the standards, in order to avoid damage to persons or goods, is the user's responsibility.

**EXAMPLE 7**

**Application: Guard monitoring**

Reference standard EN ISO 13849-1

Safety category

**4**

Performance Level

**PL e**

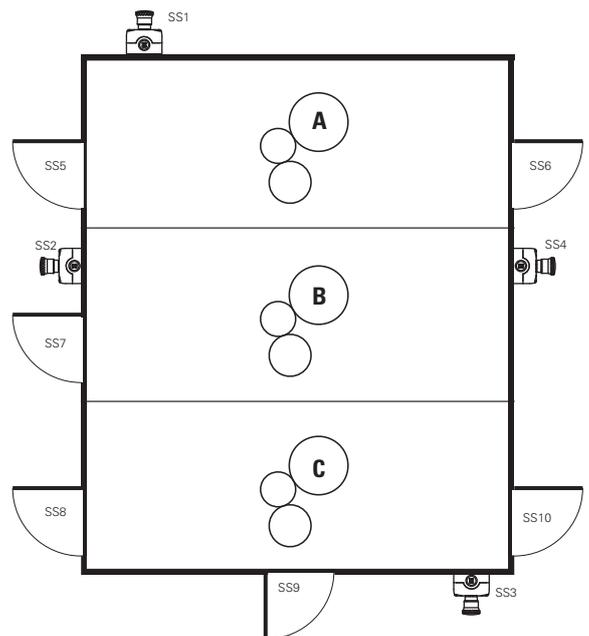
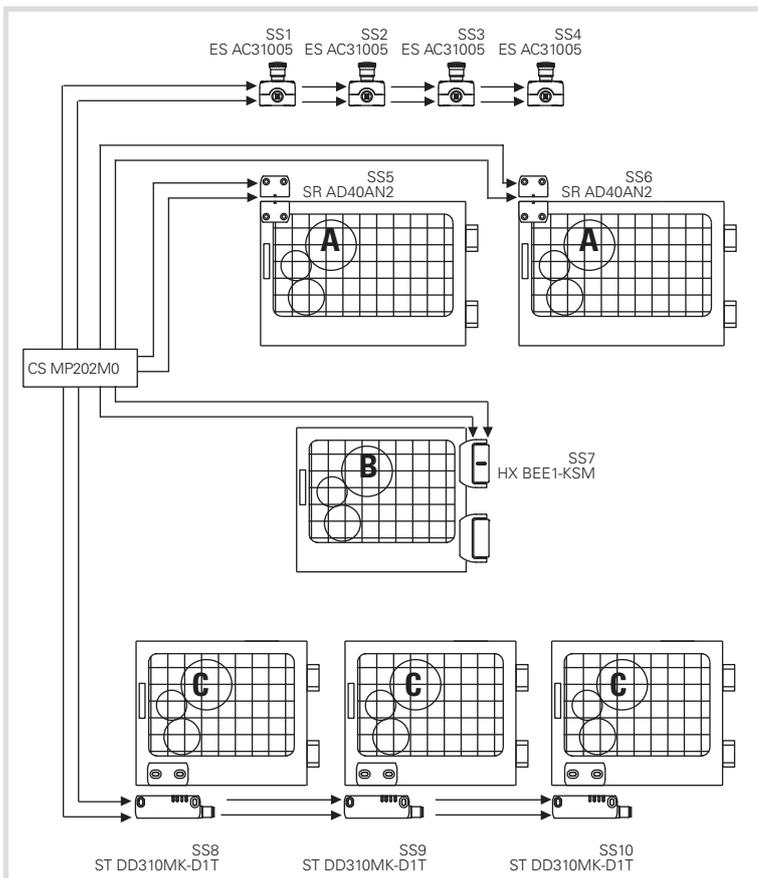
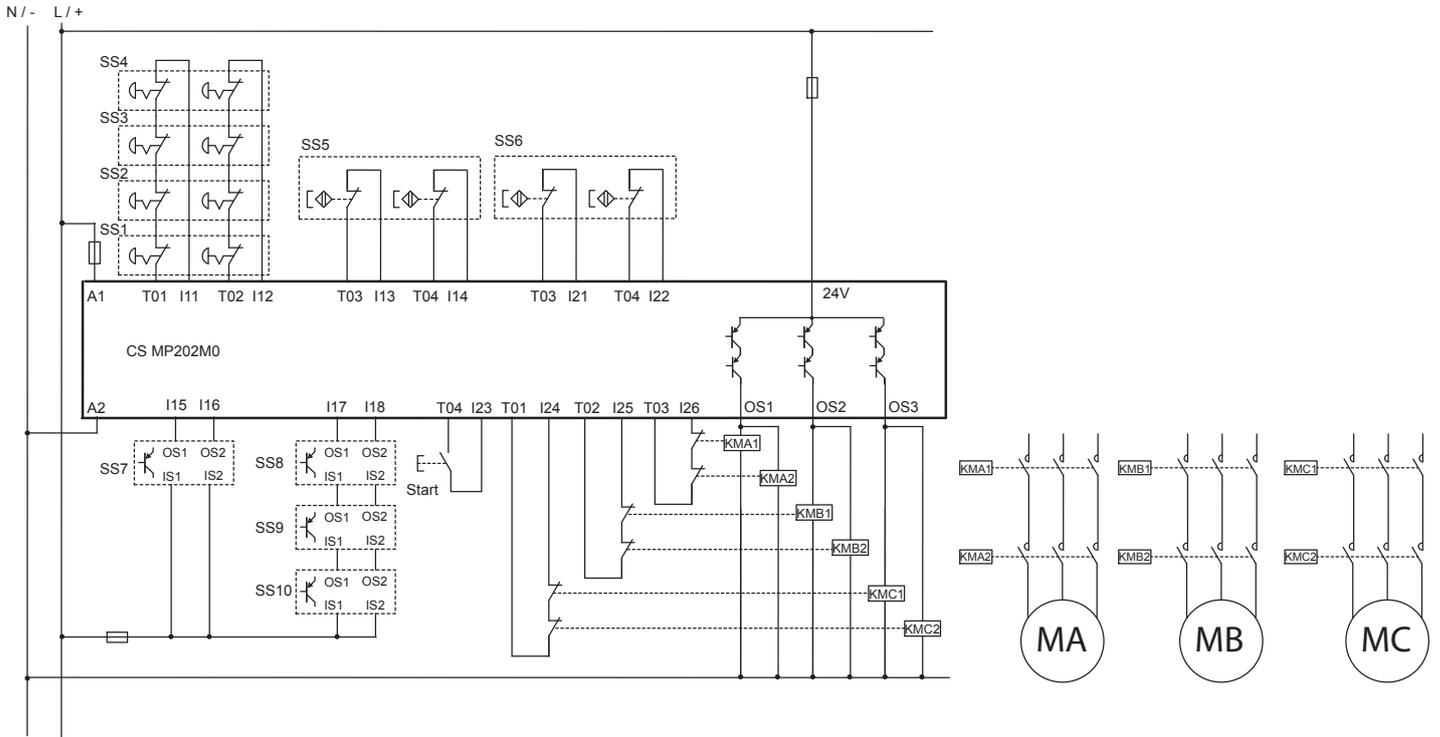



### Description of the safety function

Every machine is divided into 3 different zones. The access to each zone is monitored by the guards and 4 emergency stop buttons are present too.

The operation of an emergency stop button will trigger the CS MP safety module as well as the forcibly guided contactors KMA1/2, KMB1/2 and KMC1/2, and will therefore stop all motors.

The opening of a guard in zone A triggers the devices SS5 or SS6 and, as a consequence, the CS MP safety module as well as the contactors KMA1 and KMA2, and therefore also the stop of the MA motor. The devices SS5 and SS6 are connected to the CS MP safety module separately, with a two-channel connection.

The opening of the guard in zone B triggers the device SS7 and, as a consequence, the CS MP safety module as well as the contactors KMB1 and KMB2, and therefore also the stop of the MB motor. The SS7 hinge is provided with two OSSD outputs and is redundantly controlled by the CS MP safety module.

The opening of a guard in zone C triggers the devices SS8, SS9 or SS10 and, as a consequence, the safety module as well as the contactors KMC1 and KMC2, and therefore also the stop of the MC motor. The sensors SS8, SS9 and SS10 are interconnected via the OSSD outputs and are redundantly monitored by the CS MP safety module.

### Device data

- SS1, SS2, SS3 and SS4 (ES AC31005) are emergency stop buttons (E2 1PERZ4531) provided with 2 NC contacts.  $B_{10D} = 600,000$
- SS5 and SS6 (SR AD40AN2) are magnetic safety sensors.  $B_{10D} = 20,000,000$
- SS7 (HX BEE1-KSM) is a safety hinge with OSSD outputs.  $MTTF_D = 4,077$  years / DC = 99%
- SS8, SS9 and SS10 (ST DD310MK-D1T) are safety sensors with RFID technology and OSSD outputs.  $MTTF_D = 4,077$  years / DC = 99%
- KMA, KMB and KMC are contactors operated at nominal load.  $B_{10D} = 1,300,000$  (see EN ISO 13849-1 - Table C.1)
- CS MP202M0 is a safety module with  $MTTF_D = 2035$  years / DC = 99%

### Assumption of the frequency of use

- Each door of zone A is opened 2 times per hour for 16 h/day for 365 days/year equal to  $n_{op}/year = 11,680$ . The contactors will operate for twice the number of operations = 23,360
- The door of zone B is opened 4 times per hour for 16 h/day for 365 days/year equal to  $n_{op}/year = 23,360$ . The contactors will operate for a given number of operations = 23,360
- Each door of zone C is opened 1 times per hour for 16 h/day for 365 days/year equal to  $n_{op}/year = 5,840$ . The contactors will operate for a given number of operations = 17,520
- It is assumed that the emergency button is actuated at a maximum of once a week,  $n_{op}/year = 52$
- Fault Exclusion: since it is assumed that the pairs of contactors, connected in parallel to the respective safety outputs, are wired permanently within the switching cabinet, the possibility of short-circuit between +24V and the contactors is excluded (see Table D.4, item D.5.2 of EN ISO 13849-2).

### MTTF<sub>D</sub> calculation

#### Emergency stop buttons

- $MTTF_D$  SS1/SS2/SS3/SS4 = 115,384 years
- $MTTF_D$  CS = 2035 years
- $MTTF_D$  KMC1,KMC2 = 742 years
- $MTTF_D$  e-stop = 541 years

#### Guards, zone A

- $MTTF_D$  SS5/SS6 = 17,123 years
- $MTTF_D$  CS = 2035 years
- $MTTF_D$  KMA1,KMA2 = 556 years
- $MTTF_D$  A = 425 years (SS5/SS6,CS,KMA)

#### Guards, zone B

- $MTTF_D$  SS7 = 4,077 years
- $MTTF_D$  CS = 2035 years
- $MTTF_D$  KMB1,KMB2 = 556 years
- $MTTF_D$  B = 394 years (SS7,CS,KMB)

#### Guards, zone C

- $MTTF_D$  SS8/SS9/SS10 = 4,077 years
- $MTTF_D$  CS = 2035 years
- $MTTF_D$  KMC1,KMC2 = 742 years
- $MTTF_D$  C = 479 years (SS8/SS9/SS10,CS,KMC)

### Diagnostic Coverage DC<sub>avg</sub>

- The contacts of KMA, KMB and KMC are monitored by the CS MP module via the feedback circuit. DC=99%
- All faults in the various devices can be detected. DC=99%
- The CS MP202M0 module has a DC=99%
- The result is a diagnostic coverage of 99% for each function

### CCF Common Cause Failures

- We assume a score > 65 for all safety functions (acc. to EN ISO 13849-1 - Annex F).

### PL determination

- A circuit in category 4 with  $MTTF_D \geq 30$  years (High) and  $DC_{avg} =$  High corresponds to PL e.
- All safety functions associated to the guards and the emergency stop buttons have PL e.

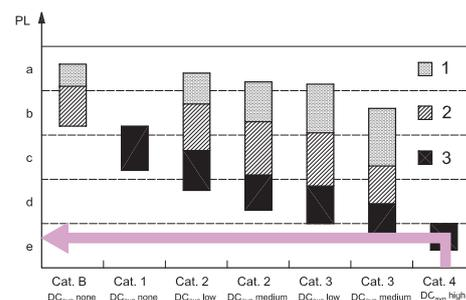

**EXAMPLE 8**

**Application: Guard monitoring**

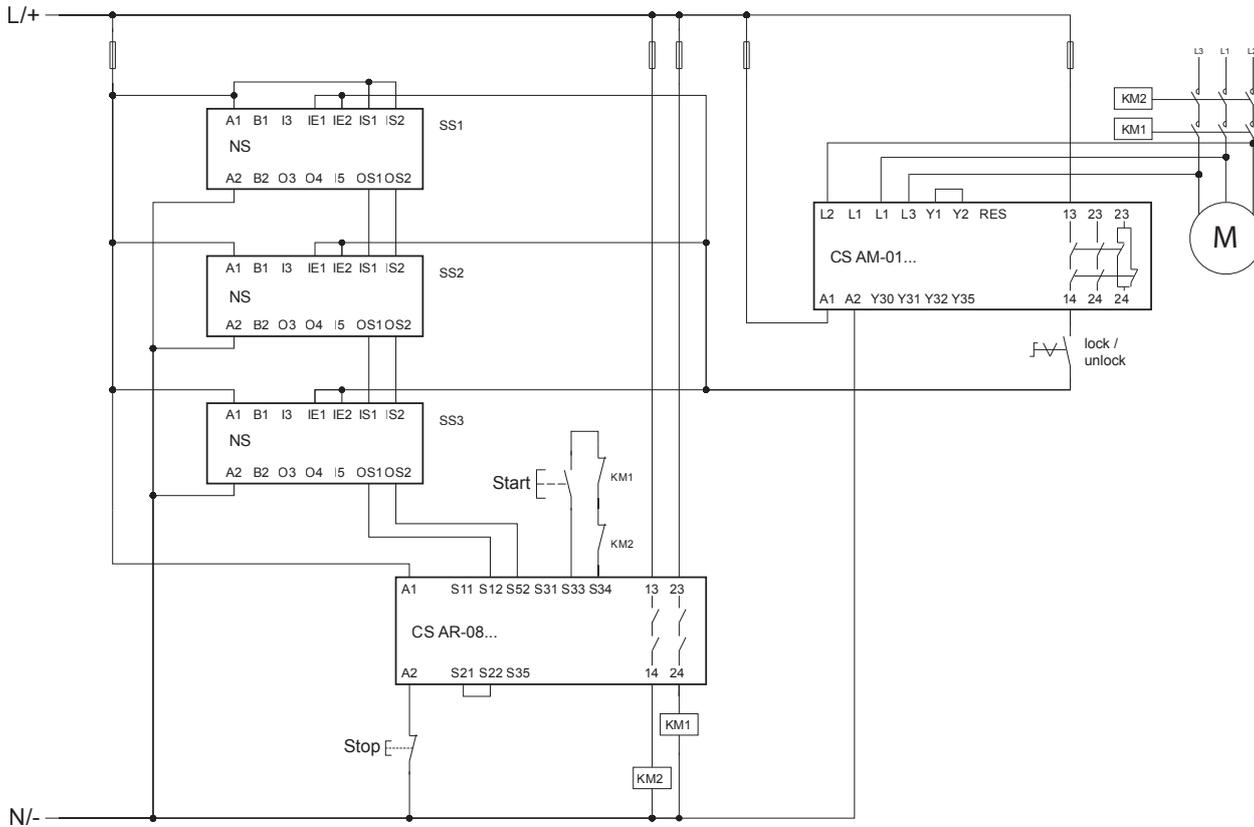

Reference standard EN ISO 13849-1

Performance Level - Safety function 1

**PL e**

Performance Level - Safety function 2

**PL d**

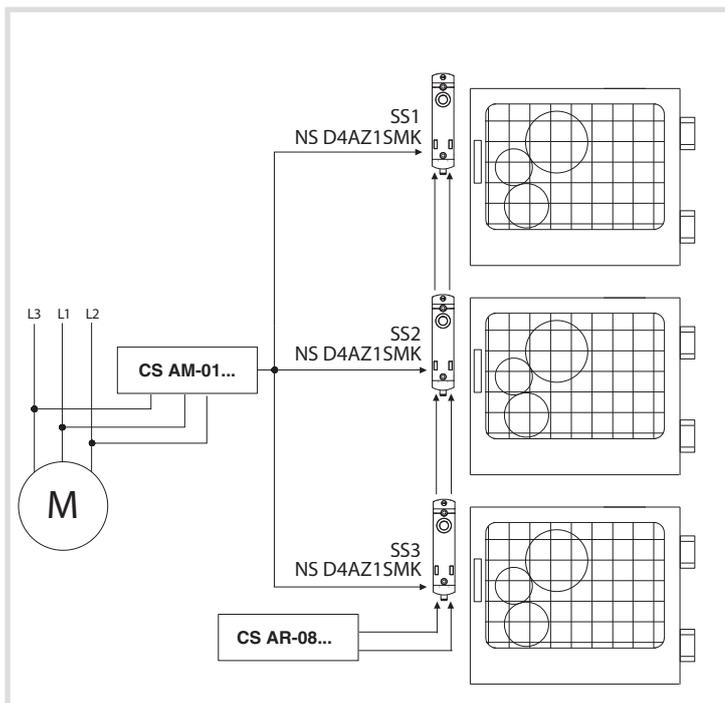

### Description of the safety function

Interlocking devices SS1, SS2 and SS3 perform two safety functions: monitoring the locked state and locking the guard. Once the guards have been released, the three sensors trigger the safety module and the contactors KM1 and KM2 too. The contactors KM1 and KM2 (with forcibly guided contacts) are monitored by the CS AR-08 via the feedback circuit. The interlock command on the three devices SS1, SS2 and SS3 is maintained until the motor standstill monitoring module CS AM-01 detects the actual stopping of movement.

### Device data

SS1, SS2, SS3 are NS series coded interlock devices with RFID technology, with guard locking device. Locked protection detection function  $PFH_D = 1.22E-09$  PL = "e" operating of locking control  $PFH_D = 2.29E-10$  PL = "e".

CS AR-08 is a safety module,  $PFH_D = 9.73 E-11$ , PL = "e".

CS AM-01 is a safety module for motor standstill monitoring,  $PFH_D = 8,70E-09$ , PL "d".

KM1 and KM2 are contactors operated at nominal load.  $B10_D = 1,300,000$  (see EN ISO 13849-1 - Table C.1)

### Assumption of the frequency of use

Each door is opened every 10 minutes, 16 hours a day, for 365 days a year, equal to  $n_{op}/year = 35,040$

### Definition of the SRP/CS and subsystems

This application example presents two safety functions:

1. Safety-related stop function initiated by a protective measure
2. Maintain interlock of the guard with motor M in motion

The safety function 1 is performed by an SRP/CS consisting of 5 subsystems (SB):

- SB11,12,13 represent the three RFID interlock devices of the NS series: SS1, SS2 and SS3
- SB14 represents the safety module CS AR-08
- SB15 represents the two contactors KM1 and KM2 in redundant architecture (cat. 4)



The safety function 2 is performed by 2 subsystems (SB):

- SB21 represents the CS AM-01 safety module for motor standstill monitoring
- SB22 represents the three NS series RFID interlock devices



### PFH<sub>D</sub> calculation for SB15

$MTTF_D$  KM1, KM2 = 371 years.

DC = 99%, the contacts of KM1 and KM2 are monitored by the CS safety module via the feedback circuit.

For the CCF parameter we assume a score higher than 65 (acc. to EN ISO 13849-1 - Annex F).

A category 4 circuit with  $MTTF_D = 371$  and high diagnostic coverage (DC = 99%) corresponds to a failure probability of  $PFH_D = 6.3E-09$  and a PL "e".

### Calculation of the total PFH<sub>D</sub> of the SRP/CS safety function 1

$$PFH_{DTOT} = PFH_{DSB11} + PFH_{DSB12} + PFH_{DSB13} + PFH_{DSB14} + PFH_{DSB15} = 1E-08$$

It corresponds to PL "e".

### Calculation of the total PFH<sub>D</sub> of the SRP/CS safety function 2

$$PFH_{DTOT} = PFH_{DSB21} + PFH_{DSB22} = 8.9E-09$$

That would correspond to PL "e". However, considering that the motor standstill monitoring module is characterised by a PL "d", and that the unlock command takes place via a single-channel architecture, the entire SRP/CS is downgraded to this value, therefore PL "d".

Calculation example performed with SISTEMA software, downloadable free of charge at [www.pizzato.com](http://www.pizzato.com)

**EXAMPLE 9**

**Application: Guard monitoring**

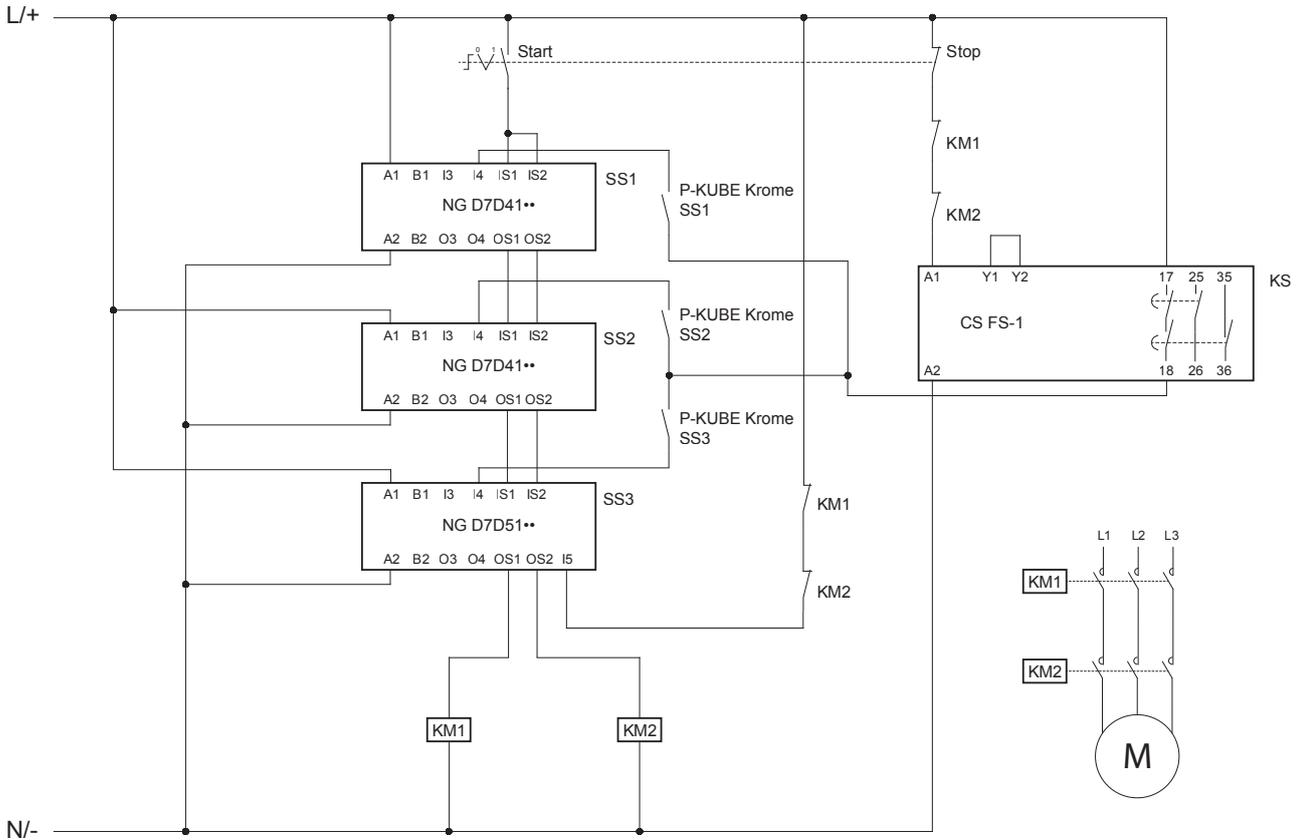

Reference standard EN ISO 13849-1

Performance Level - Safety function 1

**PL e**

Performance Level - Safety function 2

**PL d**

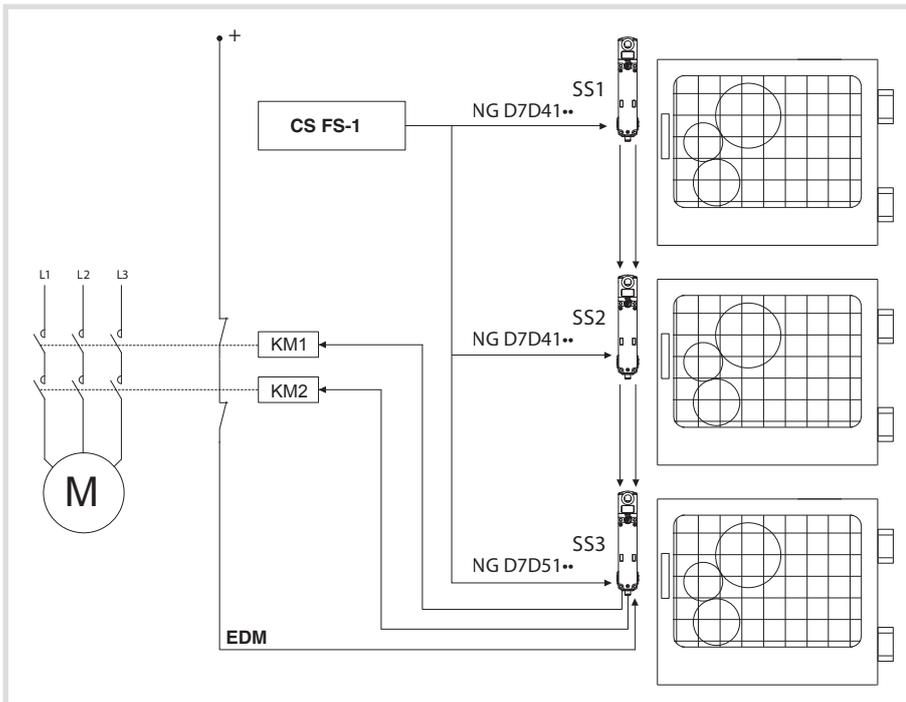

### Description of the safety function

Interlocking devices SS1, SS2 and SS3 perform two safety functions: monitoring the locked state and locking the guard.

Once the guards have been released, the three sensors act directly on contactors KM1 and KM2. Contactors KM1 and KM2 (with forcibly guided contacts) are controlled by the SS3 sensor, via EDM (External Device Monitoring) input I5.

The interlock command on the three devices SS1, SS2 and SS3 depends on the closure of the safe contact of a CS FS-1 safety timer module. Each device will receive the unlock command, when the button mounted on the P-KUBE Krome handle is pressed.

### Device data

SS1, SS2, SS3 are coded interlock devices with RFID technology, with guard locking device. Locked protection detection function  $PFH_D = 1,17E-09$  PL = "e", single channel locking control function  $PFH_D = 1,51E-10$  PL = "d".

CS FS-1 is a safety timer module,  $PFH_D = 5.06E-10$ , PL "e".

KM1 and KM2 are contactors operated at nominal load.  $B10d = 1.300.000$  (see EN ISO 13849-1 - Table C.1)

### Assumption of the frequency of use

Each door is opened every 10 minutes, 16 hours a day, for 365 days a year, equal to  $nop = 35,040$

### Definition of the SRP/CS and subsystems

This application example presents two safety functions:

1. Safety-related stop function initiated by a protective measure
2. Maintain interlock of the guard with motor M1 in motion

The safety function 1 is performed by an SRP/CS consisting of 4 subsystems (SB):

- SB11,12,13 represent the three RFID interlock devices of the NG series: SS1, SS2 and SS3
- SB14 represents the two contactors KM1 and KM2 in redundant architecture (cat. 4)

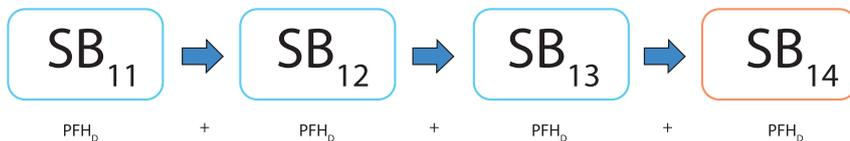

The safety function 2 is performed by 2 subsystems (SB):

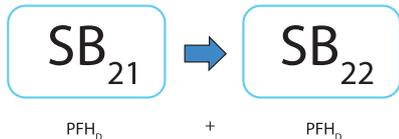

- SB21 represents the safety timer module CS FS-1

- SB22 represents the NG series RFID interlocking device

### PFH<sub>D</sub> calculation for SB14

$MTTF_D$  KM1,KM2 = 371 years.

DC = 99%, the KM1 and KM2 contacts are monitored by the last NG device in the series, via the EDM input.

For the CCF parameter we assume a score higher than 65 (acc. to EN ISO 13849-1 - Annex F).

A category 4 circuit with  $MTTF_D = 371$  and high diagnostic coverage (DC = 99%) corresponds to a failure probability of  $PFH_D = 6.3E-09$  and a PL "e".

### Calculation of the total PFH<sub>D</sub> of the SRP/CS safety function 1

$PFH_{DTOT} = PFH_{DSB11} + PFH_{DSB12} + PFH_{DSB13} + PFH_{DSB14} = 9.8E-09$

It corresponds to PL "e".

### Calculation of the total PFH<sub>D</sub> of the SRP/CS safety function 2

$PFH_{DTOT} = PFH_{DSB21} + PFH_{DSB22} = 6.6E-10$

That would correspond to PL "e". Considering however, that the NG device with single channel interlock command is characterized by a PL "d", the entire SRP/CS is downgraded to this value; therefore PL "d".

## Definitions according to the EN 60947-1 and EN 60947-5-1 standards

### Control switches

Devices or operating mechanisms for controlling the operation of equipment, including signalling, interlocking, etc.

### Utilization category

Combination of specified requirements related to the conditions in which the switching device fulfils its purpose.

### Operating cycle

Sequence of two operations, one for opening and one for closing.

### Rated current $I_e$

This current depends on the rated operating voltage, the rated frequency, the utilization category and the type of protective enclosure, if present.

### Thermal current $I_{th}$

Maximum current for heating tests on equipment without enclosure, in free air. Its value shall be least to equal to the maximum value of the rated operational current  $I_e$  of the equipment without enclosure, in eight-hour duty.

### Electrical endurance

Number of on-load operating cycles, under the conditions defined by the corresponding product standard, which can be carried out without repair or replacement.

### Mechanical endurance

Number of no-load operating cycles (i.e. without current on the main contacts), under the conditions defined by the corresponding product standard, which can be carried out without repair or replacement of mechanical parts.

### Contact elements

The parts, fixed or movable, conducting or insulating, of a control switch necessary to close and open one single conducting path of a circuit.

### Single interruption contact elements

Contact element opening or closing the circuit's conducting path at one point only.

### Double interruption contact elements

Contact element opening or closing the circuit's conducting path at two points in series.

### Make-contact elements (normally open)

Contact element closing a circuit's conducting path when the control switch is actuated.

### Break-contact elements (normally closed)

Contact element opening a circuit's conducting path when the control switch is actuated.

### Change-over contact elements

Contact element combination including one make-contact element and one break-contact element.

### Electrically separated contact elements

Contact elements of the same control switch which are well isolated from each other and therefore can be connected to electric circuits with different voltages.

### Contact elements with independent action (snap action)

Contact element of a manual or automatic device for control circuits where the motion speed of the contact is substantially independent from the motion speed of the actuator.

### Contact elements with dependent action (slow action)

Contact element of a manual or automatic device for control circuits where the motion speed of the contact depends on the motion speed of the actuator.

### Minimum actuating force

Minimum force to be applied to the actuator that will cause all contacts to reach their switched position.

### Position switch

Control switch whose controller is actuated by a moving part of the machine, when this part arrives to a set position.

### Foot switch

Control switch whose actuator is actuated by exerting force with a foot on the pedal.

### Pre-travel of the actuator

The maximum travel of the actuator which does not cause any travel of the contact elements.

### Ambient temperature

The air temperature surrounding the complete switching device, under prescribed conditions.

### Rated operating voltage $U_e$

Voltage which, combined with the rated operational current  $I_e$ , determinates the application of the equipment and the referred utilization categories.

### Rated insulation voltage $U_i$

Reference voltage for the dielectric test voltage and the creepage distances along surfaces.

### Rated impulse withstand voltage $U_{imp}$

The highest peak value of an impulse voltage, of a prescribed shape and polarity, which does not cause destructive discharge under the specified test conditions.

### Contact block

Contact element or contact elements combination which can be combined with similar units, operated by a common actuating system

## Markings and quality marks

### CE marking



The CE marking is a mandatory declaration made by the manufacturer of a product in order to indicate that the product satisfies all requirements foreseen by the directives (regulated by the European Community) in terms of safety and quality. Therefore, it ensures National bodies of the EU countries about the fulfilment of obligations laid down in the agreements.

### IMQ mark



The IMQ (Italian Institute of the Quality Mark) is an association in Italy (independent third body) whose task is to check and certify the compliance of materials and equipment with safety standards (CEI standards in the electric and electronic sector). This voluntary conformity certification is a guarantee of quality, safety and technical value.

### UL mark



UL (Underwriters Laboratories Inc.) is an independent non-profit body that tests materials, devices, products, equipment, constructions, methods and systems with regard to their risk for human life and goods according to the standard in force in the United States and Canada. Decisions made by UL are often recognized by many governing authorities concerning the compliance with local safety regulations.

### CCC mark



The CQC is the organization in the Chinese Popular Republic whose task is to check and certify the low voltage electrical material. This organization issues the product mark CCC which certifies the passing of electrical/mechanical conformity tests by products and the compliance of the company quality system with required standards. To obtain the mark, the Chinese body makes preliminary company visits as well as periodical check inspections. Position switches cannot be sold in the Chinese territory without this mark.

### TÜV SÜD mark



TÜV SÜD is an international authority claiming long-standing experience in the certification of operating safety for electrical, electromechanical and electronic products. In the course of type approval, TÜV SÜD closely inspects the quality throughout all the stages concerning product development, from software design and completion, to production and to the tests conducted according to ISO/IEC standards. The operating safety certification is obtained voluntarily and has a high technical value, since it not only certifies the electrical safety of the product, but also its specific operating suitability for use in safety applications according to the IEC 61508 standard.

### EAC mark



The EAC certificate of conformity is a certificate issued by a Customs Union certification body formed by Russia, Belarus and Kazakhstan, with which the conformity of a product is certified with the essential safety requirements laid down by one or more Technical Regulations (Directives) of the Customs Union.

### ECOLAB mark



ECOLAB is one of the world's leading providers of technologies and services for hygiene in food processing. ECOLAB certifies the compatibility of tested electrical devices in its own laboratories, using disinfectants and cleaning agents used in the area of food processing worldwide.

## International and European Standards

**EN 50041:** Low voltage switchgear and controlgear for industrial use. Control switches. Position switches 42.5x80 mm. Dimensions and features

**EN 50047:** Low voltage switchgear and controlgear for industrial use. Control switches. Position switches 30x55 mm. Dimensions and features

**EN ISO 14119:** Safety of machinery. Interlocking devices associated with guards. Design and selection principles.

**EN ISO 12100:** Safety of machinery. General design principles. Risk assessment and risk reduction.

**EN ISO 13849-1:** Safety of machinery. Safety-related parts of control systems. Part 1: General principles for design.

**EN ISO 13850:** Safety of machinery. Emergency stop devices, functional aspects. Design principles.

**EN 61000-6-3 (equivalent to IEC 61000-6-3):** Electromagnetic compatibility. Generic emission standard. Part 1: residential, commercial and light-industrial environments.

**EN 61000-6-2 (equivalent to IEC 61000-6-2):** Electromagnetic compatibility. Generic immunity standard. Part 2: Industrial environments.

**EN ISO 13855:** Safety of machinery. Positioning of safeguards with respect to the approach speeds of parts of the human body.

**EN 1037:** Safety of machinery. Prevention of unexpected start-up.

**EN 574:** Safety of machinery. Two-hand control devices. Functional aspects. Principles for design.

**EN 60947-1 (equivalent to IEC 60947-1):** Low-voltage switchgear and controlgear. Part 1: General rules.

**EN 60947-5-1 (equivalent to IEC 60947-5-1):** Low-voltage switchgear and controlgear. Part 5: Devices for control and operation circuits. Section 1: Electromechanical control circuit devices.

**EN 60947-5-2:** Low-voltage switchgear and controlgear. Part 5-2: Control circuit devices and switching elements - Proximity switches

**EN 60947-5-3:** Low-voltage switchgear and controlgear. Part 5-3: Control circuit devices and switching elements - Requirements for proximity devices with defined behaviour under fault conditions (PDF)

**EN 60204-1 (equivalent to IEC 60204-1):** Safety of machinery. Electrical equipment of machines. Part 1: General rules.

**EN 60529 (equivalent to IEC 60529):** Protection degree of the housings (IP codes).

**ISO 20653:** Road vehicles-degrees of protection (IP CODE)

**EN 62326-1 (equivalent to IEC 62326-1):** Printed boards. Part 1: Generic specification

**EN 60664-1 (equivalent to IEC 60664-1):** Insulation coordination for equipment within low-voltage systems Part 1: Principles, requirements and tests.

**EN 61508 (equivalent to IEC 61508):** Functional safety of electrical, electronic and programmable electronic systems for safety applications.

**EN 62061 (equivalent to IEC 62061):** Safety of machinery - Functional safety of safety-related electrical, electronic and programmable electronic control systems.

**EN 60079-0 (equivalent to IEC 60079-0):** Electrical devices for potentially explosive atmospheres. General rules

**EN 60079-11 (equivalent to IEC 60079-11):** Electrical apparatus for potentially explosive atmospheres. Intrinsic safety "i"

**EN 60079-31 (equivalent to IEC 60079-31):** Electrical apparatus for potentially explosive atmospheres. Type of protection: "n"

**EN 60079-28 (equivalent to IEC 60079-28):** Electrical apparatus for use in the presence of combustible dust. Part 1-1: Construction and testing

**EN 50581:** Technical documentation for the evaluation of electrical and electronic products in relation to the restriction of hazardous substances

**BG-GS-ET-15:** Prescriptions about how to test switches with forced contact opening to be used in safety applications (German standard).

**UL 508:** Standards for industrial control equipment. (American standard).

**CSA 22-2 No.14:** Standards for industrial control equipment. (Canadian standard).

### European directives

2014/35/EU	Directive on low-voltage switchgear and controlgear
2006/42/EC	Machinery Directive
2014/30/EU	Directive on electromagnetic compatibility
2014/34/EU	ATEX Directive
2011/65/UE	RoHS Directive

### Regulatory Organisations

<b>CEI</b>	Comitato Elettrotecnico Italiano (IT)	<b>NF</b>	Normes Françaises (FR)
<b>CSA</b>	Canadian Standard Association (CAN)	<b>VDE</b>	Verband Deutscher Elektrotechniker (DE)
<b>CENELEC</b>	European Committee for Electrotechnical Standardisation	<b>UNI</b>	Ente Nazionale Italiano di Unificazione (IT)
<b>CEN</b>	European Committee for Standardisation	<b>UL</b>	Underwriter's Laboratories (USA)
<b>IEC</b>	International Electrotechnical Commission	<b>TÜV</b>	Technischer Überwachungs-Verein (DE)

### Protection degree of housings for electrical material according to EN 60529

The following table reports the required protection degrees according to the IEC 60529, EN 60529, CEI 70-1 standards.

The protection degrees are indicated by the abbreviation IP and 2 following digits. 2 additional letters can be reported indicating protection of persons or other features. The first digit shows the degree of protection against penetration of external solid materials. The second digit identifies instead the protection degree against liquid penetration.

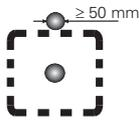
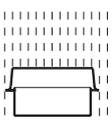
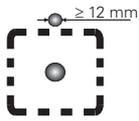
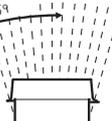
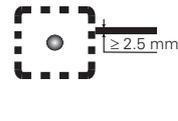
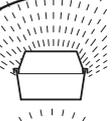
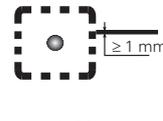
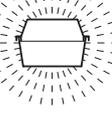
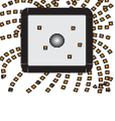
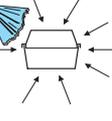
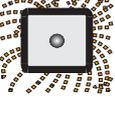
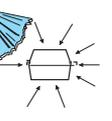
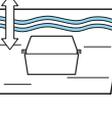
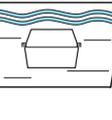
1st digit	Description	Protection for the machine	Protection for persons	2nd digit	Description	Protection for the machine
<b>0</b>		Not protected	Not protected	<b>0</b>		Not protected
<b>1</b>		Protected against solid objects greater than 50 mm	Against access to hazardous parts with the back of a hand (Ø 50 mm)	<b>1</b>		Protected against vertically falling water drops
<b>2</b>		Protected against solid objects greater than 12 mm	Against access to hazardous parts with a finger (Ø 12 mm)	<b>2</b>		Protected against water drops falling at max. 15° angle
<b>3</b>		Protected against solid objects greater than 2.5 mm	Against access to hazardous parts with a tool (Ø 2.5 mm)	<b>3</b>		Protected against rain drops falling at max. 60° angle
<b>4</b>		Protected against solid objects greater than 1 mm	Against access to hazardous parts with a wire (Ø 1 mm)	<b>4</b>		Protected against splash water from any direction
<b>5</b>		Protected against dust	Against access to hazardous parts with a wire (Ø 1 mm)	<b>5</b>		Protected against water jets from any direction
<b>6</b>		Totally protected against dust	Against access to hazardous parts with a wire (Ø 1 mm)	<b>6</b>		Protected against powerful water jets from any direction (e.g. waves)
				<b>7</b>		Protected against temporary water immersion (30 minutes at one-meter depth)
				<b>8</b>		Protected against continuous immersion in water



## Protection degree IP69K according to ISO 20653

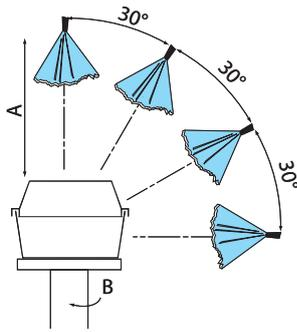

ISO 20653 envisages a particularly strenuous test. This test simulates the conditions of pressure washing in industrial environments with water jets having pressure between 80 and 100 bar, flow rate between 14 and 16 l/min. and a temperature of 80°C.

Test specifications:

Rotation speed (B):	5 ± 1 rpm
Distance from water jet (A):	100 +50/-0 mm
Water flow rate:	15 ± 1 l/min
Water pressure:	9000 ± 1000 kPa
Water temperature:	80 ± 5 °C
Test duration:	30 s per position

## Housing data in accordance with UL (UL 508) and CSA (C22-2 no.14) approvals

The features required for a housing are determined by a specific environmental designation and other features such as the kind of gasket or the use of solvent materials.

Type	Intended use and description
1	Mainly for indoor utilization, supplied with protection against contact with the internal mechanism and against a limited quantity of falling dirt.
4X	Suitable for both indoor and outdoor use, provided with protection degree against falling rain, water splashes and direct coming water from a pipe. No damage caused by ice formation on the housing. Corrosion-resistant.
12	Indoor utilization, provided with a protection degree against dust, dirt, flying fibres, dripping water and outside condensation of non-corrosive fluids.
13	Indoor utilization, supplied with a protection degree against gauze, dust penetration, outside condensation and sprinkling of water, oil and non-corrosive fluids.

## Pollution degree (of environmental conditions) according to EN 60947-1

According to the EN 60947-1 standard, the pollution degree is a conventional number based on the quantity of conducting hygroscopic dust, ionized gas or salt, and on the relative humidity and its frequency of occurrence resulting in hygroscopic absorption or condensation of moisture leading to reduction in dielectric strength and/or surface resistivity. In equipment to be used inside a housing or having an integral enclosure as part of the device, the pollution degree applies to the inner part of housing. With the purpose of evaluating the air and surface insulation distances, the following four pollution degrees are defined:

Degree	Description
1	No pollution or only dry and non-conductive pollution occurs.
2	Normally, only non-conductive pollution is present. Occasionally some temporary conductivity caused by condensation may occur.
3	Some conductive pollution is present, or some dry non-conductive pollution that becomes conductive because of condensation.
4	Pollution causes persistent conductivity, for instance due to conductive dust or rain or snow.

Where not otherwise specified by the applicable standards for the product, equipment for industrial applications are generally intended for their use in environment with pollution degree 3. Nevertheless, other degrees can be considered, depending on the micro-environment or on particular applications.

## Use in alternating and direct current of auxiliary devices acc. to EN 60947-5-1

Alternating current use

Utilization category	Intended use
AC12	Control of resistive loads and solid state loads with insulation by optocouplers.
AC13	Control of solid state loads with transformer isolation
AC14	Control of electromagnetic loads, power ≤ 72 VA
AC15	Control of electromagnetic loads, power ≥ 72 VA

Direct current use

Utilization category	Intended use
DC12	Control of resistive loads and solid state loads with insulation by optocouplers.
DC13	Control of electromagnetic loads without economy resistors in circuit
DC14	Control of electromagnetic loads with economy resistors in circuit

Legend:

CS AR-03●●●● → CS AR-08●●●● The codes in grey have been replaced by the code after the arrow

Old Article	New Article
CS AR-03●●●● →	CS AR-08●●●●
CS AT-0A●●●● →	CS AT-00●●●●-TF0.5
CS AT-0B●●●● →	CS AT-00●●●●-TF1
CS AT-0C●●●● →	CS AT-00●●●●-TF3
CS AT-0D●●●● →	CS AT-00●●●●-TF10
CS AT-1A●●●● →	CS AT-10●●●●-TF0.5
CS AT-1B●●●● →	CS AT-10●●●●-TF1
CS AT-1C●●●● →	CS AT-10●●●●-TF3
CS AT-1D●●●● →	CS AT-10●●●●-TF10
CS AT-2●●●● →	CS AT-3●●●●
CS FS-0●●●● →	CS FS-1●●●●
CS FS-0A●●●● →	CS FS-00●●●●-TF0.5
CS FS-0B●●●● →	CS FS-00●●●●-TF1
CS FS-0C●●●● →	CS FS-00●●●●-TF3
CS FS-0D●●●● →	CS FS-00●●●●-TF10
CS ME-2AVU24 →	CSME-20VU24-TF0.5
CS ME-2BVU24 →	CS ME-20VU24-TF1
CS ME-2EVU24 →	CS ME-20VU24-TF2
CS ME-2CVU24 →	CS ME-20VU24-TF3
VF IL●●●●●● →	VF SL●●●●●●

# General terms and conditions of sale

## Order sending procedure:

Purchase orders must always be sent in writing (e-mail). We reserve the right to not accept e-mail orders in case of missing information necessary to correctly identify the sender or to reject them in case of virus infected attachments or attachments of dubious origin.

## Minimum invoicing amount:

Unless specifically agreed, the minimum invoicing amount is EUR 200 net (VAT excluded). For invoices of less than EUR 200, a EUR 30 fee will be applied.

Invoices are issued weekly.

## Prices:

The prices quoted in the price list do not include VAT, custom duties or any other charges. Unless otherwise agreed, the prices quoted in the price list are not binding and may undergo changes.

## Order quantities:

Some products are shipped in packs. The ordered quantities of these items must be multiples of the quantities contained in the packages.

## Changes and cancellation of orders:

Changes and cancellation of orders might be accepted depending on the progress of the order. Changes or cancellation of orders for special items will not be accepted.

## Supply:

The supply includes only what is expressly stated in the order confirmation. In compliance with article 1461 of the Italian Civil Code, we reserve the right to suspend the supply in case of changes in the customer's financial standing.

## Delivery:

The delivery is indicated in the order confirmation and shows the period in which the goods can be available at the factories of Pizzato Elettrica and not the date of arrival at the customer's premises. This period is an approximate value and cannot be opposed as proof of non-compliance with the order.

Stock items are indicated on the website [www.pizzato.com](http://www.pizzato.com)

## Packaging:

Packaging is free. For more than six boxes pallets can be necessary for the transport.

## Shipment:

Unless expressly agreed between the parties, Pizzato Elettrica ships goods Ex Works, in accordance with Incoterms 2010 (published by the ICC). If the customer, for his convenience, requests a transport to be charged on the invoice, it is understood between the parties that the goods always travel at the risk and peril of the customer. The customer must check that the forwarder delivers the number of boxes indicated in the delivery note, that the boxes are intact and that the weight corresponds to what is stated in the documents. In case of any inconsistencies, please always accept the goods indicating on the document SUBJECT TO VERIFICATION, clearly specifying the type of damage. Any discrepancy or mistake must be reported in writing within 8 days from the date of receipt of the goods at [info@pizzato.com](mailto:info@pizzato.com).

## Warranty:

The warranty has a validity of 12 months starting from the shipping date of the material. The warranty does not cover products damaged due to improper use, negligence or installation. The warranty does not cover parts subjected to wear, products used out of the technological limits described in the catalogue, or items that have not received an adequate maintenance. Pizzato Elettrica undertakes to repair or replace all or part of products that present evident and proved manufacturing defects, provided that they are still covered by warranty.

Pizzato Elettrica is only responsible for the value of the product and requests for compensation due to machine downtime, repairs or costs for direct or indirect damages resulting from product malfunctions will not be accepted, even if these occur during the warranty period. It is the responsibility of the manufacturer to evaluate the importance of the products used and the possible damage caused by their malfunction and consequently adopt the necessary technical measures in order to minimise consequences, also for personal safety purposes (redundant systems, self controlled systems, etc). The warranty will be subject to the customer's compliance with the payment terms.

Any samples provided free of charge or bearing the phrase "SAMPLE" must be considered as purely demonstrative and are not covered by warranty.

## Products:

Products can be subjected to technical improvements in any moment without prior notice.

## Payment terms:

Payments must be settled within the terms established in the order confirmation. The payment method is always at the risk of the customer, whatever the method is. In case of delayed payment, Pizzato Elettrica reserves the right to stop deliveries of orders and charge interest as prescribed by European Directive 2011/7/EU. Any technical or commercial complaints do not entitle the claimant to suspend the due payments.

## Returns:

Any return for any reason will not be accepted unless previously APPROVED and AUTHORISED in writing.

Otherwise, Pizzato Elettrica reserves the right to reject the goods and send them back at the expense of the customer. Returns have to be received no later than 3 months from the date of authorisation. After this period, returns will not be accepted. Returns involve a devaluation with respect to their sales price and will be accepted for standard items shipped no more than 12 months earlier. The returned goods and their packaging must be intact and undamaged.

## Ownership:

The delivered products remain the property of Pizzato Elettrica until the balance of the payments due.

## Disputes:

For any dispute, the Court of Vicenza will have sole jurisdiction.

For the updated conditions of sale, please consult the website [www.pizzato.com](http://www.pizzato.com)













Any information or application example, connection diagrams included, described in this document are to be intended as purely descriptive. The choice and application of the products in conformity with the standards, in order to avoid damage to persons or goods, is the user's responsibility.

The drawings and data contained in this catalogue are not binding and we reserve the right, in order to improve the quality of our products, to modify them at any time without prior notice.

They are also property of Pizzato Elettrica and can be reproduced only with our written permission.

All rights reserved. © 2019 Copyright Pizzato Elettrica



General Catalogue  
Detection



General Catalogue  
HMI

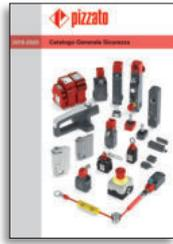

General Catalogue  
Safety

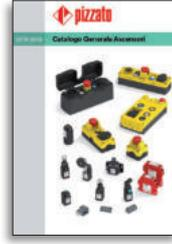

General Catalogue  
LIFT



Website  
[www.pizzato.com](http://www.pizzato.com)



PASSION FOR QUALITY

**Pizzato Elettrica s.r.l.** Via Torino, 1 - 36063 Marostica (VI) Italy  
Phone +39.0424.470.930  
E-mail: [info@pizzato.com](mailto:info@pizzato.com)  
Web site: [www.pizzato.com](http://www.pizzato.com)

ZE GCS03A18-ENG



8 018851 489341